



International Institute for
Applied Systems Analysis

MESSAGEix-GLOBIOM

Release 2020

IIASA Energy, Climate, and Environment (ECE) Program

Mar 18, 2021

CONTENTS

1	Overview	3
2	Socio-economic development	9
3	Energy (MESSAGE<i>ix</i>)	13
4	Macro-economy (MACRO)	49
5	Land-use (GLOBIOM)	51
6	Water	61
7	Emissions	63
8	Climate (MAGICC)	67
9	Annex: mathematical formulation	69
10	Further reading	71
	Bibliography	75

These pages document the IIASA Integrated Assessment Modeling (IAM) framework, also referred to as MESSAGEix-GLOBIOM, owing to the fact that the energy model MESSAGEix and the land use model GLOBIOM are its most important components. MESSAGEix-GLOBIOM was developed for the quantification of the so-called Shared Socio-economic Pathways (SSPs) which are the first application of the IAM framework.

This documentation is under constant development and is being expanded with additional information to reflect the latest changes in the modeling framework.

When referring to MESSAGEix-GLOBIOM as described in this document, please use the following citations:¹

- V. Krey, P. Havlik, P. N. Kishimoto, O. Fricko, J. Zilliacus, M. Gidden, M. Strubegger, G. Kartasasmita, T. Ermolieva, N. Forsell, M. Gusti, N. Johnson, J. Kikstra, G. Kindermann, P. Kolp, F. Lovat, D. L. McCollum, J. Min, S. Pachauri, Parkinson S. C., S. Rao, J. Rogelj, H. and Ünlü, G. Valin, P. Wagner, B. Zakeri, M. Obersteiner, and K. Riahi. MESSAGEix-GLOBIOM Documentation – 2020 release. Technical Report, International Institute for Applied Systems Analysis (IIASA), Laxenburg, Austria, 2020. URL: <https://pure.iiasa.ac.at/id/eprint/17115>, doi:10.22022/iacc/03-2021.17115.
- O. Fricko, P. Havlik, J. Rogelj, Z. Klimont, M. Gusti, N. Johnson, P. Kolp, M. Strubegger, H. Valin, M. Amann, T. Ermolieva, N. Forsell, M. Herrero, C. Heyes, G. Kindermann, V. Krey, D. L. McCollum, M. Obersteiner, S. Pachauri, S. Rao, E. Schmid, W. Schoepp, and K. Riahi. The marker quantification of the Shared Socioeconomic Pathway 2: A middle-of-the-road scenario for the 21st century. *Global Environmental Change*, 42:251–267, 2017. doi:10.1016/j.gloenvcha.2016.06.004.

The MESSAGEix-GLOBIOM Integrated Assessment Model is based on the MESSAGEix framework, an open-source energy systems optimization modelling environment including macro-economic feedback using a stylized computable general equilibrium model. When referring to the software underpinning MESSAGEix-GLOBIOM rather than the data or specific assessments, please see the “[User guidelines and notice](#)” section of the documentation, which indicates to use at least the following citation:

- Daniel Huppmann, Matthew Gidden, Oliver Fricko, Peter Kolp, Clara Orthofer, Michael Pimmer, Nikolay Kushin, Adriano Vinca, Alessio Mastrucci, Keywan Riahi, and Volker Krey. The MESSAGEix Integrated Assessment Model and the ix modeling platform (ixmp): An open framework for integrated and cross-cutting analysis of energy, climate, the environment, and sustainable development. *Environmental Modelling & Software*, 112:143–156, 2019. doi:10.1016/j.envsoft.2018.11.012.

We thank Edward Byers, Jessica Jewell, Ruslana Palatnik, Narasimha D. Rao, and Fabio Sferra for their valuable comments that helped improving this manuscript.

¹ Download these citations in RIS or BibTeX format (web only).

OVERVIEW

The IIASA IAM framework consists of a combination of five different models or modules - the energy model MESSAGE*ix*, the land use model GLOBIOM, the air pollution and GHG model GAINS, the aggregated macro-economic model MACRO and the simple climate model MAGICC - which complement each other and are specialized in different areas. All models and modules together build the IIASA IAM framework, also referred to as MESSAGE*ix*-GLOBIOM owing to the fact that the energy model MESSAGE*ix* and the land use model GLOBIOM are its central components. The five models provide input to and iterate between each other during a typical scenario development cycle. Below is a brief overview of how the models interact with each other, specifically in the context of developing the SSP scenarios.

MESSAGE*ix* (Huppmann et al., 2019 [[31]]) represents the core of the IIASA IAM framework (Fig. 1.1) and its main task is to optimize the energy system so that it can satisfy specified energy demands at the lowest costs. MESSAGE carries out this optimization in an iterative setup with MACRO, a single sector macro-economic model, which provides estimates of the macro-economic demand response that results from energy system and services costs computed by MESSAGE*ix*. For the six commercial end-use demand categories depicted in MESSAGE (see *Energy demand*), based on demand prices MACRO will adjust useful energy demands, until the two models have reached equilibrium (see *Macro-economy (MACRO)*). This iteration reflects price-induced energy efficiency adjustments that can occur when energy prices change. MESSAGE can represent different energy- and climate-related *Policies*.

GLOBIOM provides MESSAGE*ix* with information on land use and its implications, including the availability and cost of bioenergy, and availability and cost of emission mitigation in the AFOLU (Agriculture, Forestry and Other Land Use) sector (see *Land-use (GLOBIOM)*). To reduce computational costs, MESSAGE iteratively queries a GLOBIOM emulator which provides an approximation of land-use outcomes during the optimization process instead of requiring the GLOBIOM model to be rerun iteratively. Only once the iteration between MESSAGE*ix* and MACRO has converged, the resulting bioenergy demands along with corresponding carbon prices are used for a concluding analysis with the full-fledged GLOBIOM model. This ensures full consistency of the results from MESSAGE and GLOBIOM, and also allows producing a more extensive set of land-use related indicators, including spatially explicit information on land use.

Air pollution implications of the energy system are accounted for in MESSAGE*ix* by applying technology-specific air pollution coefficients derived from the GAINS model (see *Air pollution*). This approach has been applied to the SSP process (Rao et al., 2017 [[75]]). Alternatively, GAINS can be run ex-post based on MESSAGE*ix*-GLOBIOM scenarios to estimate air pollution emissions, concentrations and the related health impacts. This approach allows analyzing different air pollution policy packages (e.g., current legislation, maximum feasible reduction), including the estimation of costs for air pollution control measures. Examples for applying this way of linking MESSAGE*ix*-GLOBIOM and GAINS can be found in McCollum et al. (2018 [[53]]) and Grubler et al. (2018 [[21]]).

In general, cumulative global carbon emissions from all sectors are constrained at different levels, with equivalent pricing applied to other GHGs, to reach the desired radiative forcing levels (cf. right-hand side Fig. 1.1). The climate constraints are thus taken up in the coupled MESSAGE*ix*-GLOBIOM optimization, and the resulting carbon price is fed back to the full-fledged GLOBIOM model for full consistency. Finally, the combined results for land use, energy, and industrial emissions from MESSAGE*ix* and GLOBIOM are merged and fed into MAGICC (see *Climate (MAGICC)*), a global carbon-cycle and climate model, which then provides estimates of the climate implications in terms of atmospheric concentrations, radiative forcing, and global-mean temperature increase. Importantly, climate impacts and impacts of the carbon cycle are – depending on the specific application – currently only partly accounted for in the IIASA IAM framework. The entire framework is linked to an online database infrastructure which allows straightforward visualisation, analysis, comparison and dissemination of results (Riahi et al., 2017 [[84]]).

The scientific software underlying the global MESSAGE-GLOBIOM model is called the MESSAGEix framework, an open-source, versatile implementation of a linear optimization problem, with the option of coupling to the computable general equilibrium (CGE) model MACRO to incorporate the effect of price changes on economic activity and demand for commodities and resources. MESSAGEix is integrated with the *ix modeling platform* (ixmp), a “data warehouse” for version control of reference timeseries, input data and model results. ixmp provides interfaces to the scientific programming languages Python and R for efficient, scripted workflows for data processing and visualisation of results (Huppmann et al., 2019 [[31]]).

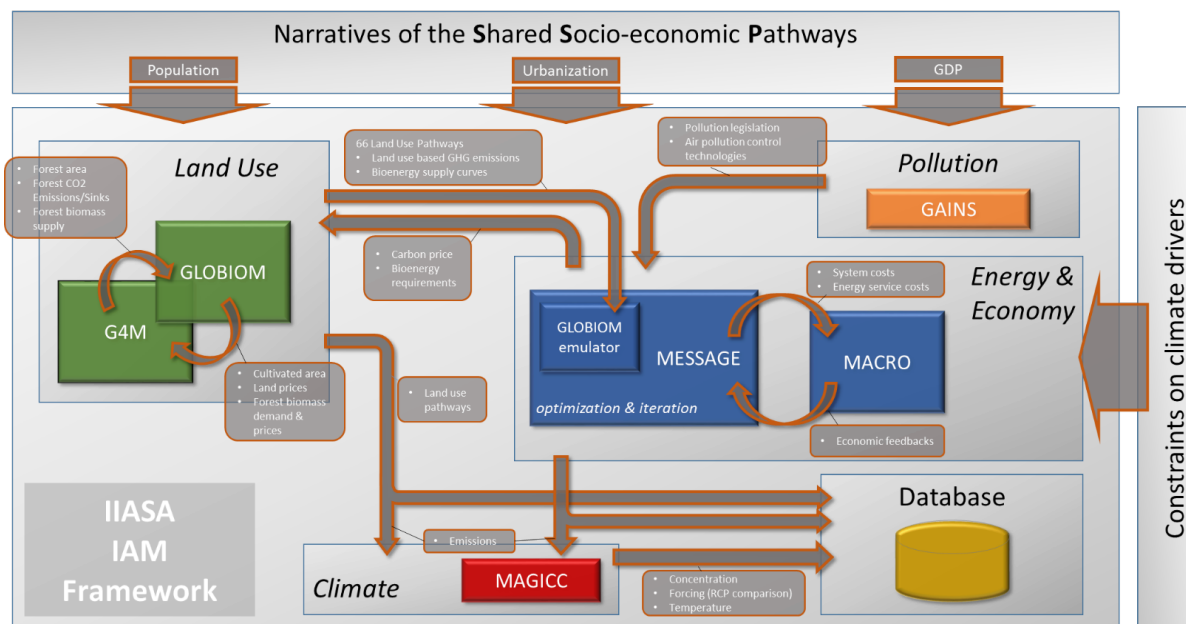
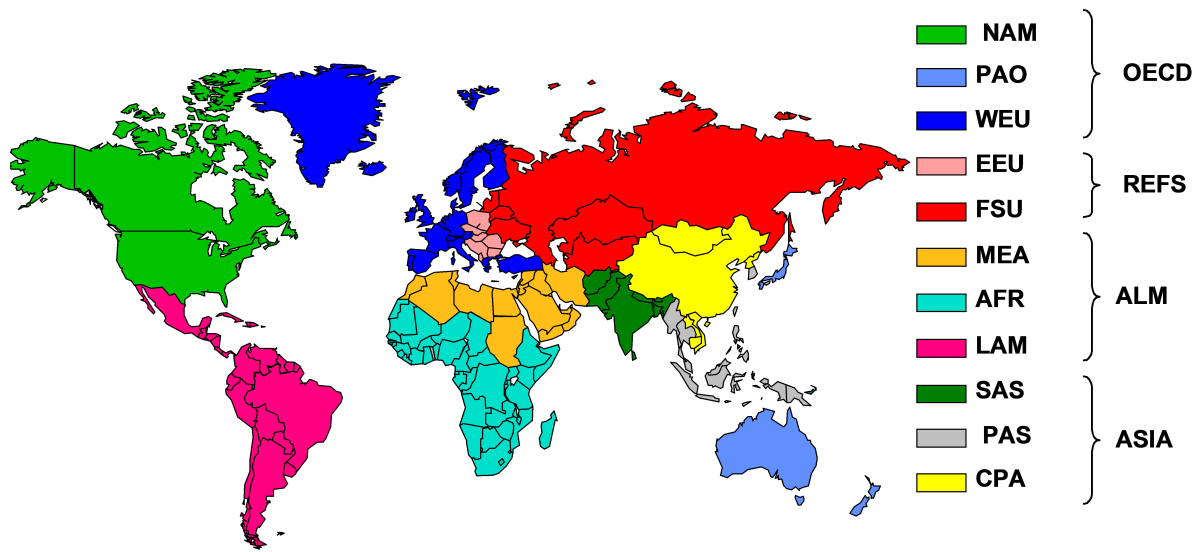

Fig. 1.1: Overview of the IIASA IAM framework. Coloured boxes represent respective specialized disciplinary models which are integrated for generating internally consistent scenarios (Fricko et al., 2017 [[17]]).

1.1 Regions

The combined MESSAGEix-GLOBIOM framework has global coverage and divides the world into 11 regions which are also the native regions of the MESSAGEix model (see Fig. 1.2 and Table 1.1 below). GLOBIOM natively operates at the level of 30 regions which in the linkage to MESSAGEix are aggregated to the 11 regions as listed in Table 1.2.

The country definitions of the 11 MESSAGEix regions are described in the table below (Table 1.1). In some scenarios, the MESSAGEix region of FSU (Former Soviet Union) is disaggregated into four sub-regions resulting in a 14-region MESSAGEix model.



- | | | |
|--|---|----------------------------------|
| 1 NAM North America | 5 FSU Former Soviet Union | 9 SAS South Asia |
| 2 LAM Latin America & The Caribbean | 6 MEA Middle East & North Africa | 10 PAS Other Pacific Asia |
| 3 WEU Western Europe | 7 AFR Sub-Saharan Africa | 11 PAO Pacific OECD |
| 4 EEU Central & Eastern Europe | 8 CPA Centrally Planned Asia & China | |

Fig. 1.2: Map of 11 MESSAGEix-GLOBIOM regions including their aggregation to the four regions used in the Representative Concentration Pathways (RCPs).

Table 1.1: Listing of 11 regions used in MESSAGEix-GLOBIOM, including their country definitions.

MES-SAGE regions	Definition	List of countries
NAM	North America	Canada, Guam, Puerto Rico, United States of America, Virgin Islands
WEU	Western Europe	Andorra, Austria, Azores, Belgium, Canary Islands, Channel Islands, Cyprus, Denmark, Faeroe Islands, Finland, France, Germany, Gibraltar, Greece, Greenland, Iceland, Ireland, Isle of Man, Italy, Liechtenstein, Luxembourg, Madeira, Malta, Monaco, Netherlands, Norway, Portugal, Spain, Sweden, Switzerland, Turkey, United Kingdom
PAO	Pacific OECD	Australia, Japan, New Zealand
EEU	Central and Eastern Europe	Albania, Bosnia and Herzegovina, Bulgaria, Croatia, Czech Republic, The former Yugoslav Rep. of Macedonia, Hungary, Poland, Romania, Slovak Republic, Slovenia, Yugoslavia, Estonia, Latvia, Lithuania
FSU	Former Soviet Union	Armenia, Azerbaijan, Belarus, Georgia, Kazakhstan, Kyrgyzstan, Republic of Moldova, Russian Federation, Tajikistan, Turkmenistan, Ukraine, Uzbekistan
CPA	Centrally Planned Asia and China	Cambodia, China (incl. Hong Kong), Korea (DPR), Laos (PDR), Mongolia, Viet Nam
SAS	South Asia	Afghanistan, Bangladesh, Bhutan, India, Maldives, Nepal, Pakistan, Sri Lanka
PAS	Other Pacific Asia	American Samoa, Brunei Darussalam, Fiji, French Polynesia, Gilbert-Kiribati, Indonesia, Malaysia, Myanmar, New Caledonia, Papua, New Guinea, Philippines, Republic of Korea, Singapore, Solomon Islands, Taiwan (China), Thailand, Tonga, Vanuatu, Western Samoa
MEA	Middle East and North Africa	Algeria, Bahrain, Egypt (Arab Republic), Iraq, Iran (Islamic Republic), Israel, Jordan, Kuwait, Lebanon, Libya/SPLAJ, Morocco, Oman, Qatar, Saudi Arabia, Sudan, Syria (Arab Republic), Tunisia, United Arab Emirates, Yemen
LAM	Latin America and the Caribbean	Antigua and Barbuda, Argentina, Bahamas, Barbados, Belize, Bermuda, Bolivia, Brazil, Chile, Colombia, Costa Rica, Cuba, Dominica, Dominican Republic, Ecuador, El Salvador, French Guyana, Grenada, Guadeloupe, Guatemala, Guyana, Haiti, Honduras, Jamaica, Martinique, Mexico, Netherlands Antilles, Nicaragua, Panama, Paraguay, Peru, Saint Kitts and Nevis, Santo Lucia, Saint Vincent and the Grenadines, Suriname, Trinidad and To

1.1. Regions

In addition to the 11 geographical regions, in the global MESSAGEix model there is a global trade region where market clearing of global energy markets is happening and international shipping bunker fuel demand, uranium resource extraction and the nuclear fuel cycle are represented.

Table 1.2: Listing of 30 regions used in GLOBIOM, including their country definitions and the mapping to the 11 regions of the combined MESSAGEix-GLOBIOM model.

MES-SAGE regions	GLOBIOM regions	List of countries
NAM	Canada	Canada
	USA	United States of America
WEU	EU_MidWest	Austria, Belgium, Germany, France, Luxembourg, Netherlands
	EU_North	Denmark, Finland, Ireland, Sweden, United Kingdom
	EU_South	Cyprus, Greece, Italy, Malta, Portugal, Spain
	ROWE	Gibraltar, Iceland, Norway, Switzerland
PAO	Turkey	Turkey
	ANZ	Australia, New Zealand
	Japan	Japan
EEU	Pacific_Islands	Fiji Islands, Kiribati, Papua New Guinea, Samoa, Solomon Islands, Tonga, Vanuatu
	EU_Baltic	Estonia, Latvia, Lithuania
	EU_CentEast	Bulgaria, Czech Republic, Hungary, Poland, Romania, Slovakia, Slovenia
	RCEU	Albania, Bosnia and Herzegovina, Croatia, Macedonia, Serbia-Montenegro
FSU	Former_USSR	Armenia, Azerbaijan, Belarus, Georgia, Kazakhstan, Kyrgyzstan, Moldova, Russian Federation, Tajikistan, Turkmenistan, Ukraine, Uzbekistan
CPA	China	China
	RSEA_PAC	Cambodia, Korea DPR, Laos, Mongolia, Viet Nam
SAS	India	India
	RSAS	Afghanistan, Bangladesh, Bhutan, Maldives, Nepal, Pakistan, Sri Lanka
PAS	South_Korea	South Korea
	RSEA_OPA	Brunei Daressalaam, Indonesia, Singapore, Malaysia, Myanmar, Philippines, Thailand
MEA	MidEastNAfr	Algeria, Bahrain, Egypt, Iran, Iraq, Israel, Jordan, Kuwait, Lebanon, Libya, Morocco, Oman, Qatar, Saudi Arabia, Syria, Tunisia, United Arab Emirates, Yemen
LAM	Brazil	Brazil
	Mexico	Mexico
	RCAM	Bahamas, Barbados, Belize, Bermuda, Costa Rica, Cuba, Dominica, Dominican Republic, El Salvador, Grenada, Guatemala, Haiti, Honduras, Jamaica, Nicaragua, Netherland Antilles, Panama, St Lucia, St Vincent, Trinidad and Tobago
AFR	RSAM	Argentina, Bolivia, Chile, Colombia, Ecuador, Guyana, Paraguay, Peru, Suriname, Uruguay, Venezuela
	Congo_Basin	Cameroon, Central African Republic, Congo Republic, Democratic Republic of Congo, Equatorial, Guinea, Gabon
	EasternAf	Burundi, Ethiopia, Kenya, Rwanda, Tanzania, Uganda
	SouthAf	South Africa
	RoSAfr	Angola, Botswana, Comoros, Lesotho, Madagascar, Malawi, Mauritius, Mozambique, Namibia, Swaziland, Zambia, Zimbabwe
	WestCentAfr	Benin, Burkina Faso, Cape Verde, Chad, Cote d'Ivoire, Djibouti, Eritrea, Gambia, Ghana, Guinea, Guinea Bissau, Liberia, Mali, Mauritania, Niger, Nigeria, Senegal, Sierra Leone, Somalia, Sudan, Togo

1.2 Time steps

In global MESSAGEix models the time horizon of 2010 to 2110 is generally subdivided into 5 or 10-year periods, using 2010 or 2015 as the base year. The 2020 period is partly calibrated so far, some recent trends are included in this time period, but some flexibility remains. The reporting years are the final years of periods which implies that investments that lead to the capacities in the reporting year are the average annual investments over the entire period the reporting year belongs to. In recent model versions, the model has been calibrated to 2015 running with 5-year modeling periods until the middle of the century (2020, 2025, 2030, 2035, 2040, 2045, 2050, 2055, 2060) and 10-year periods between 2060 and 2110.

MESSAGEix can both operate perfect foresight over the entire time horizon, limited foresight (e.g., two or three periods into the future) or myopically, optimizing one period at a time (Keppo and Strubegger, 2010 [[41]]) (see [Mathematical Specification](#) for more details). Most frequently MESSAGEix is run with perfect foresight, but for specific applications such as delayed participation in a global climate regime without anticipation (Krey and Riahi, 2009 [[46]]; O'Neill et al., 2010 [[67]]) limited foresight is used.

GLOBIOM models the time horizon 2000 to 2100 in 10 year time steps (2000, 2010, 2020, 2030, 2040, 2050, 2060, 2070, 2080, 2090, 2100) with the year 2000 being the base year of the model. The model is recursive-dynamic, i.e. it is solved for each period individually and then passes on results to the subsequent periods. The linkage between MESSAGEix and GLOBIOM relies on the model results of the periods 2020 to 2100.

1.3 Policies

A number of different energy- and climate-related policies are, depending on the scenario setup and the research question addressed, explicitly represented in MESSAGEix. This includes the following list of policies:

- GHG emission pricing
- GHG emission caps and trading emission allowances
- Renewable energy portfolio standards (e.g., share of renewable energy in electricity generation)
- Renewable energy and other technology capacity targets
- Energy import tariffs
- Fuel subsidies and micro-financing for achieving universal access to modern energy services in developing countries (via linkage to the [MESSAGE-Access model](#))
- Air pollution legislation packages (fixed legislation, current and planned legislation, stringent legislation, maximum feasible reduction via linkage to the [GAINS model](#))

In general, these policies are implemented via constraints or cost coefficients (negative and positive) in the optimization problem (see Section [Modeling policies](#) for more details). In the case of air pollution policies, the different legislation packages are implemented via a set of emission coefficients and associated costs derived from the [GAINS model](#). The cost coefficients are, however, not part of the optimization procedure, but instead allow an ex-post quantification of air pollution policy costs for a specific energy scenario.

SOCIO-ECONOMIC DEVELOPMENT

2.1 Behavioural change

With increasing affluence, consumers of final energy are more likely to demand technologies that are more convenient in their use, even if they cost more than less convenient energy forms. Examples of this empirically observed phenomenon are room heating with gas, electricity or district heat, which are more convenient than heating with coal. The affluent end-user does not like to fill up the coal furnace manually and is willing to pay more for a convenient technology. If MESSAGEix is to correctly reflect this phenomenon, the model's cost-minimizing behavior must be modified accordingly. As a model feature to accomplish this task, the concept of inconvenience factors has been introduced in the definition of end-use technologies. The inconvenience factors are specified for each end-use technology, time period and world region. The cost entry in the objective function is calculated as the monetary costs, multiplied by the inconvenience factor. The inconvenience factors for a given world region increase with the level of affluence (GDP per capita) in this region. Flexible and grid-dependent energy technologies, such as electricity, gas and district heating have low inconvenience factors. A second mechanism for taking into account non-monetary decision criteria in the end-use sectors is the application of implicit discount rates which change perceived upfront investment costs by consumers. These two concepts are predominantly applied in the consumer dominated energy end-use sectors transportation (see *Transport sector*) and residential and commercial (see *Residential and commercial sectors*). Below, this is described in more detail for the MESSAGEix-Access model, an extension of MESSAGEix that focuses on residential energy services in developing countries which are characterized by high reliance on traditional fuels.

2.1.1 Behavioral change in MESSAGEix-Access

MESSAGEix-Access is a variant of the MESSAGEix model that provides a detailed representation of energy use for the residential sector in developing country regions. It is fully integrated with the MESSAGEix supply side model, but not in call scenarios is the the detailed demand-side representation used, but instead a more aggregated formulation with just seven demand categories is used (see *Energy demand*) which is parametrized off the detailed MESSAGEix-Access formulation. The objective function maximizes household utility by choosing an energy-equipment combination for an individual household group that meets a particular energy service demand at lowest cost. The model is calibrated with data on existing household energy use patterns, derived from national household surveys and energy statistics and balances for the base year 2005. Assumptions regarding urbanization, income growth and changes in income distributions over time drive the model outcomes in the future. In its current version the model is implemented only for 3 of the 11 MESSAGEix regions (see *Regions*), SAS, PAS and AFR, that are developing regions where access to modern energy remains the most limited.

The model distinguishes between two primary energy end-uses in the residential sector – (1) thermal, largely cooking demand and (2) electricity demand for lighting and appliance use. Several alternative fuel and technology options can be specified in the model to meet each of these respective service demands. To reflect heterogeneity among consumers, the household or residential sector is further disaggregated into several sub-groups that distinguish among rural and urban households and five or more expenditure classes within the rural and urban sub-sectors (Fig. 2.1).

The methodology for modeling energy choices in the residential sector of this model is described in detail in Ekholm et al. (2010) [[11]] and in the Supplementary Materials section of Pachauri et al. (2013) [[68]]. In addition to energy prices, technology costs and performance parameters, and income level of a household determining the least-cost energy-equipment combination that meets a specific energy need, two additional parameters determine choices in the model. The first is referred to as the “inconvenience cost”. An inconvenience cost is a cost related to the

inconveniences associated with obtaining and using certain types of fuels. For example, gathering firewood involves an opportunity cost for the time spent in collecting it and a dis-utility to users from exposure to the smoke they inhale when it is combusted. This non-monetary cost is captured by estimating an inconvenience cost (see Ekholm et al. (2010) [[11]] for further details regarding the methodology) for each household group and fuel. This is considered an additional cost that must be taken into account by the household in making a decision regarding the choice of fuels. The second parameter that also determines energy choices for households is income dependent implicit discount rates that determine the annualized capital costs of equipment depending on their individual lifetimes.

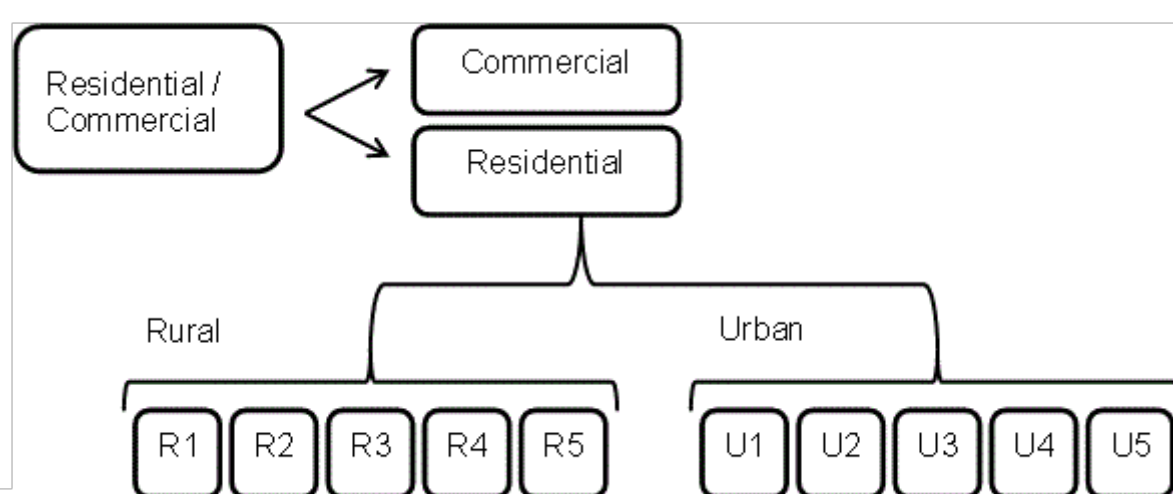

Fig. 2.1: Split of residential energy demand into different spatial (urban/rural) and income (1-5) categories.

2.2 SSP narratives

Narratives have been developed for the Shared Socioeconomic Pathways (SSPs) (O'Neill et al., 2015 [[65]]). These descriptions of alternative futures of societal development span a range of possible worlds that stretch along two climate-change-related dimensions: mitigation and adaptation challenges. The SSPs reflect five different developments of the world that are characterized by varying levels of global challenges (see Riahi et al., 2017 [[84]] for an overview). In the following, the three narratives that have been translated into quantitative scenarios with MESSAGE-GLOBIOM are presented (Fricko et al., 2017 [[17]]):

2.2.1 SSP1 Narrative: Sustainability — Taking the green road

“The world shifts gradually, but pervasively, toward a more sustainable path, emphasizing more inclusive development that respects perceived environmental boundaries. Increasing evidence of and accounting for the social, cultural, and economic costs of environmental degradation and inequality drive this shift. Management of the global commons slowly improves, facilitated by increasingly effective and persistent cooperation and collaboration of local, national, and international organizations and institutions, the private sector, and civil society. Educational and health investments accelerate the demographic transition, leading to a relatively low population. Beginning with current high-income countries, the emphasis on economic growth shifts toward a broader emphasis on human well-being, even at the expense of somewhat slower economic growth over the longer term. Driven by an increasing commitment to achieving development goals, inequality is reduced both across and within countries. Investment in environmental technology and changes in tax structures lead to improved resource efficiency, reducing overall energy and resource use and improving environmental conditions over the longer term. Increased investment, financial incentives and changing perceptions make renewable energy more attractive. Consumption is oriented toward low material growth and lower resource and energy intensity. The combination of directed development of environmentally friendly technologies, a favorable outlook for renewable energy, institutions that can facilitate international cooperation, and relatively low energy demand results in relatively low challenges to mitigation. At the same time, the improvements in human well-being, along with strong and flexible global, regional, and national institutions imply low challenges to adaptation.” (O'Neill et al., 2015 [[65]])

2.2.2 SSP2 Narrative: Middle of the Road

“The world follows a path in which social, economic, and technological trends do not shift markedly from historical patterns. Development and income growth proceed unevenly, with some countries making relatively good progress while others fall short of expectations. Most economies are politically stable. Globally connected markets function imperfectly. Global and national institutions work toward but make slow progress in achieving sustainable development goals, including improved living conditions and access to education, safe water, and health care. Technological development proceeds apace, but without fundamental breakthroughs. Environmental systems experience degradation, although there are some improvements and overall the intensity of resource and energy use declines. Even though fossil fuel dependency decreases slowly, there is no reluctance to use unconventional fossil resources. Global population growth is moderate and levels off in the second half of the century as a consequence of completion of the demographic transition. However, education investments are not high enough to accelerate the transition to low fertility rates in low-income countries and to rapidly slow population growth. This growth, along with income inequality that persists or improves only slowly, continuing societal stratification, and limited social cohesion, maintain challenges to reducing vulnerability to societal and environmental changes and constrain significant advances in sustainable development. These moderate development trends leave the world, on average, facing moderate challenges to mitigation and adaptation, but with significant heterogeneities across and within countries.” (O’Neill et al., 2015 [[65]])

2.2.3 SSP3 Narrative: Regional rivalry — A rocky road

“A resurgent nationalism, concerns about competitiveness and security, and regional conflicts push countries to increasingly focus on domestic or, at most, regional issues. This trend is reinforced by the limited number of comparatively weak global institutions, with uneven coordination and cooperation for addressing environmental and other global concerns. Policies shift over time to become increasingly oriented toward national and regional security issues, including barriers to trade, particularly in the energy resource and agricultural markets. Countries focus on achieving energy and food security goals within their own regions at the expense of broader-based development, and in several regions move toward more authoritarian forms of government with highly regulated economies. Investments in education and technological development decline. Economic development is slow, consumption is material-intensive, and inequalities persist or worsen over time, especially in developing countries. There are pockets of extreme poverty alongside pockets of moderate wealth, with many countries struggling to maintain living standards and provide access to safe water, improved sanitation, and health care for disadvantaged populations. A low international priority for addressing environmental concerns leads to strong environmental degradation in some regions. The combination of impeded development and limited environmental concern results in poor progress toward sustainability. Population growth is low in industrialized and high in developing countries. Growing resource intensity and fossil fuel dependency along with difficulty in achieving international cooperation and slow technological change imply high challenges to mitigation. The limited progress on human development, slow income growth, and lack of effective institutions, especially those that can act across regions, implies high challenges to adaptation for many groups in all regions.” (O’Neill et al., 2015 [[65]])

2.3 Population and GDP

Population and economic developments have strong implications for the anticipated mitigation and adaptation challenges. For example, a larger, poorer and less educated population will have more difficulties to adapt to the detrimental effects of climate change (O’Neill et al., 2014 [[66]]). The primary drivers of future energy demand in MESSAGEix are projections of total population and GDP at purchasing power parity exchange rates, denoted as GDP (PPP). In addition to total population, the urban/rural split of population is relevant for the MESSAGEix-Access version of the model which distinguishes rural and urban population with different household incomes in developing country regions.

Understanding how population and economic growth develops in the SSPs gives a first layer of understanding of the multiple mitigation and adaptation challenges. Population growth evolves in response to how fertility, mortality, migration, and education of various social strata are assumed to change over time. In SSP2, global population peaks at 9.4 billion people around 2070, and slowly declines thereafter (KC and Lutz, 2015 [[40]]). Gross Domestic Product (GDP) follows regional historical trends (Dellink et al., 2015 [[9]]). In SSP2, average income grows by a factor of six and reaches about 60,000 USD/capita by the end of the century (all GDP/capita figures use USD2005 and purchasing-power-parity – PPP). The SSP2 GDP projection is situated in-between the estimates for SSP1 and SSP3, which reach global average income levels of 82,000 USD2005 and 22,000 USD2005, respectively, by the end

of the century. SSP2 depicts a future of global progress where developing countries achieve significant economic growth. Today, average per capita income in the global North is about five times higher than in the global South. In SSP2, developing countries reach today's average income levels of the OECD between 2060 and 2090, depending on the region. However, modest improvements of educational attainment levels result in declines in education-specific fertility rates, leading to incomplete economic convergence across different world regions. This is particularly an issue for Africa. Overall, both the population and GDP developments in SSP2 are designed to be situated in the middle of the road between SSP1 and SSP3, see KC and Lutz (2015) [[40]], Dellink et al. (2015) [[9]] and Fricko et al. (2017) [[17]] for more details.

The full quantitative data set of demographic and economic projections for the SSPs can be found in an online database ([SSP database](#)).

ENERGY (MESSAGEIX)

The **MESSAGEix** modeling framework, briefly known also as MESSAGE (Model for Energy Supply Strategy Alternatives and their General Environmental Impact), is a linear programming (LP) energy engineering model with global coverage. As a systems engineering optimization model, MESSAGEix is primarily used for medium- to long-term energy system planning, energy policy analysis, and scenario development (Huppmann et al., 2019 [[31]]; Messner and Strubegger, 1995 [[62]]). The model provides a framework for representing an energy system with all its interdependencies from resource extraction, imports and exports, conversion, transport, and distribution, to the provision of energy end-use services such as light, space conditioning, industrial production processes, and transportation. In addition, MESSAGEix links to GLOBIOM (GLObal BIOSphere Model, cf. Section *Land-use (GLOBIOM)*) to consistently assess the implications of utilizing bioenergy of different types and to integrate the GHG emissions from energy and land use and to the aggregated macro-economic model MACRO (cf. Section *Macro-economy (MACRO)*) to assess economic implications and to capture economic feedbacks.

MESSAGEix covers all greenhouse gas (GHG)-emitting sectors, including energy, industrial processes as well as - through its linkage to GLOBIOM - agriculture and forestry. The emissions of the full basket of greenhouse gases including CO₂, CH₄, N₂O and F-gases (CF₄, C₂F₆, HFC125, HFC134a, HFC143a, HFC227ea, HFC245ca and SF₆) as well as other radiatively active gases, such as NO_x, volatile organic compounds (VOCs), CO, SO₂, and BC/OC is represented in the model. MESSAGE is used in conjunction with MAGICC (Model for Greenhouse gas Induced Climate Change) version 6.8 (cf. Section *Climate (MAGICC)*) for calculating atmospheric concentrations, radiative forcing, and annual-mean global surface air temperature increase.

The model is designed to formulate and evaluate alternative energy supply strategies consonant with the user-defined constraints such as limits on new investment, fuel availability and trade, environmental regulations and policies as well as diffusion rates of new technologies. Environmental aspects can be analysed by accounting, and if necessary limiting, the amounts of pollutants emitted by various technologies at various steps in energy supplies. This helps to evaluate the impact of environmental regulations on energy system development.

Its principal results comprise, among others, estimates of technology-specific multi-sector response strategies for specific climate stabilization targets. By doing so, the model identifies the least-cost portfolio of mitigation technologies. The choice of the individual mitigation options across gases and sectors is driven by the relative economics of the abatement measures, assuming full temporal and spatial flexibility (i.e., emissions-reduction measures are assumed to occur when and where they are cheapest to implement).

The Reference Energy System (RES) defines the full set of available energy conversion technologies. In MESSAGEix terms, energy conversion technology refers to all types of energy technologies from resource extraction to transformation, transport, distribution of energy carriers, and end-use technologies.

Because few conversion technologies convert resources directly into useful energy, the energy system in MESSAGEix is divided into 5 energy levels:

- Resources: raw resources (e.g., coal, oil, natural gas in the ground or biomass on the field)
- Primary energy: raw product at a generation site (e.g., crude oil input to the refinery)
- Secondary energy: finalized product at a generation site (e.g., gasoline or diesel fuel output from the refinery)
- Final energy: finalized product at its consumption point (e.g., gasoline in the tank of a car or electricity leaving a socket)
- Useful energy: finalized product satisfying demand for services (e.g., heating, lighting or moving people)

Technologies can take in energy commodities from one level and put out at another level (e.g., refineries produce refined oil products at secondary level from crude oil at the primary level) or at the same level (e.g., hydrogen electrolyzers produce hydrogen at the secondary energy level from electricity at the secondary level). The energy forms defined in each level can be envisioned as a transfer hub, that the various technologies feed into or pump away from. The useful energy demand is given as a time series. Technology characteristics generally vary over time period.

The mathematical formulation of MESSAGEix ensures that the flows are consistent: demand is met, inflows equal outflows and constraints are not exceeded. In other words, MESSAGEix itself is a partial equilibrium model. However, through its linkage to MACRO general equilibrium effects are taken into account (cf. Section *Macro-economy (MACRO)*).

3.1 Energy resource endowments

3.1.1 Fossil Fuel Reserves and Resources

The availability and costs of fossil fuels influences the future development of the energy system, and therewith future mitigation challenges. Understanding the variations in fossil fuel availability and the underlying extraction cost assumptions across the SSPs is hence important. Our fossil energy resource assumptions in MESSAGE are derived from various sources, including global databases such as The Federal Institute for Geosciences and Natural Resources (BGR) and The U.S. Geological Survey (USGS), as well as market reports and outlooks provided by different energy institutes and agencies. The availability of fossil energy resources in different regions under different socio-economic assumptions are then aligned with the storylines of the individual SSPs (Rogner, 1997 [[91]]; Riahi et al., 2012 [[80]]). While the physical resource base is identical across the SSPs, considerable differences are assumed regarding the technical and economic availability of overall resources, for example, of unconventional oil and gas.

What ultimately determines the attractiveness of a particular type of resource is not just the cost at which it can be brought to the surface, but the cost at which it can be used to provide energy services. Assumptions on fossil energy resources should thus be considered together with those on related conversion technologies. In line with the narratives, technological change in fossil fuel extraction and conversion technologies is assumed to be slowest in SSP1, while comparatively faster technological change occurs in SSP3 thereby considerably enlarging the economic potentials of coal and unconventional hydrocarbons (Table 3.1, Fig. 3.1). However, driven by the tendency toward regional fragmentation, the focus in SSP3 is assumed to be on developing coal technologies which in the longer term leads to a replacement of oil products by synthetic fuels based on coal-to-liquids technologies. In contrast, for SSP2 we assume a continuation of recent trends, focusing more on developing extraction technologies for unconventional hydrocarbon resources, thereby leading to higher potential cumulative oil extraction than in the other SSPs (Fig. 3.1, the middle panel).

Table 3.1 shows the assumed total quantities of fossil fuel resources in the MESSAGE model for 2005. Fig. 3.1 gives these resource estimates as cumulative resource supply curves. In addition, the assumptions are compared with estimates from the Global Energy Assessment (Rogner et al., 2012 [[90]]) and the databases mentioned earlier. Estimating fossil fuel reserves is built on both economic and technological assumptions. With an improvement in technology or a change in purchasing power, the amount that may be considered a “reserve” vs. a “resource” (generically referred to here as resources) can actually vary quite widely.

‘Reserves’ are generally defined as being those quantities for which geological and engineering information indicate with reasonable certainty that they can be recovered in the future from known reservoirs under existing economic and operating conditions. ‘Resources’ are detected quantities that cannot be profitably recovered with the current technology, but might be recoverable in the future, as well as those quantities that are geologically possible, but yet to be found. The remainder are ‘Undiscovered resources’ and, by definition, one can only speculate on their existence. Definitions are based on Rogner et al. (2012) [[90]].

Table 3.1: Assumed global fossil fuel reserves and resources in the MESSAGE model. Estimates from the Global Energy Assessment (Rogner et al., 2012 [90]) also added for comparison.

Source	MESSAGE (Rogner et al., 1997 [[91]])	Rogner et al., 2012 [[90]]	Rogner et al., 2012 [[90]]
	Reserves+Resources [ZJ]	Reserves [ZJ]	Resources [ZJ]
Coal	259	17.3 – 21.0	291 – 435
Conventional Oil	9.8	4.0 – 7.6	4.2 – 6.2
Unconventional Oil	23.0	3.8 – 5.6	11.3 – 14.9
Conventional Gas	16.8	5.0 – 7.1	7.2 – 8.9
Unconventional Gas	23.0	20.1 – 67.1	40.2 – 122

The following table (Table 3.2) presents the ultimate fossil resource availability for coal, oil and gas, for SSP1, SSP2 and SSP3, respectively.

Table 3.2: Fossil resource availability for SSP1, SSP2, and SSP3 (Fricko et al., 2017 [17]).

Type	SSP1 [ZJ]	SSP2 [ZJ]	SSP3 [ZJ]
Coal	93	92	243
Oil	17	40	17
Gas	39	37	24

Coal is the largest resource among fossil fuels; it accounts for more than 50% of total fossil reserve plus resource estimates even at the higher end of the assumptions, which includes considerable amounts of unconventional hydrocarbons. Oil is the fastest depleting fossil fuel with less than 10 ZJ of conventional oil and possibly less than 10 ZJ of unconventional oil. Natural gas is more abundant in both the conventional and unconventional categories.

Fig. 3.1 presents the cumulative global resource supply curves for coal, oil and gas in the IIASA IAM framework. Green shaded resources are technically and economically extractable in all SSPs, purple shaded resources are additionally available in SSP1 and SSP2 and blue shaded resources are additionally available in SSP2. Coloured vertical lines represent the cumulative use of each resource between 2010 and 2100 in the SSP baselines (see the top panel for colour coding), and are thus the result of the combined effect of the assumptions on fossil resource availability and conversion technologies in the SSP baseline scenarios.

Conventional oil and gas are distributed unevenly throughout the world, with only a few regions dominating the reserves. Nearly half of the reserves of conventional oil is found in Middle East and North Africa, and close to 40% of conventional gas is found in Russia and the Former Soviet Union states. The situation is somewhat different for unconventional oil of which North and Latin America potentially possess significantly higher global shares. Unconventional gas in turn is distributed quite evenly throughout the world, with North America holding most (roughly 25% of global resources). The distribution of coal reserves shows the highest geographical diversity which in the more fragmented SSP3 world contributes to increased overall reliance on this resource. Russia and the former Soviet Union states, Pacific OECD, North America, and Centrally Planned Asia and China all possess more than 10 ZJ of reserves.

3.1.2 Nuclear Resources

Estimates of available uranium resources in the literature vary considerably, which could become relevant if advanced nuclear fuel cycles (e.g., the plutonium cycle including fast breeder reactors, the thorium cycle) are not available. In MESSAGE advanced nuclear cycles such as the plutonium cycle and nuclear fuel reprocessing are in principle represented, but their availability varies following the scenario narrative. Fig. 3.2 below shows the levels of uranium resources assumed available in the MESSAGE SSP scenarios, building upon earlier work developed in the Global Energy Assessment (see Riahi et al., 2012 [[80]]). These span a considerable range of the estimates in the literature, but at the same time none of them fall at the extreme ends of the spectrum (see Rogner et al., 2012 [[90]], Section 7.5.2 for a more detailed discussion of uranium resources). Nuclear resources and fuel cycle are modeled at the global level.

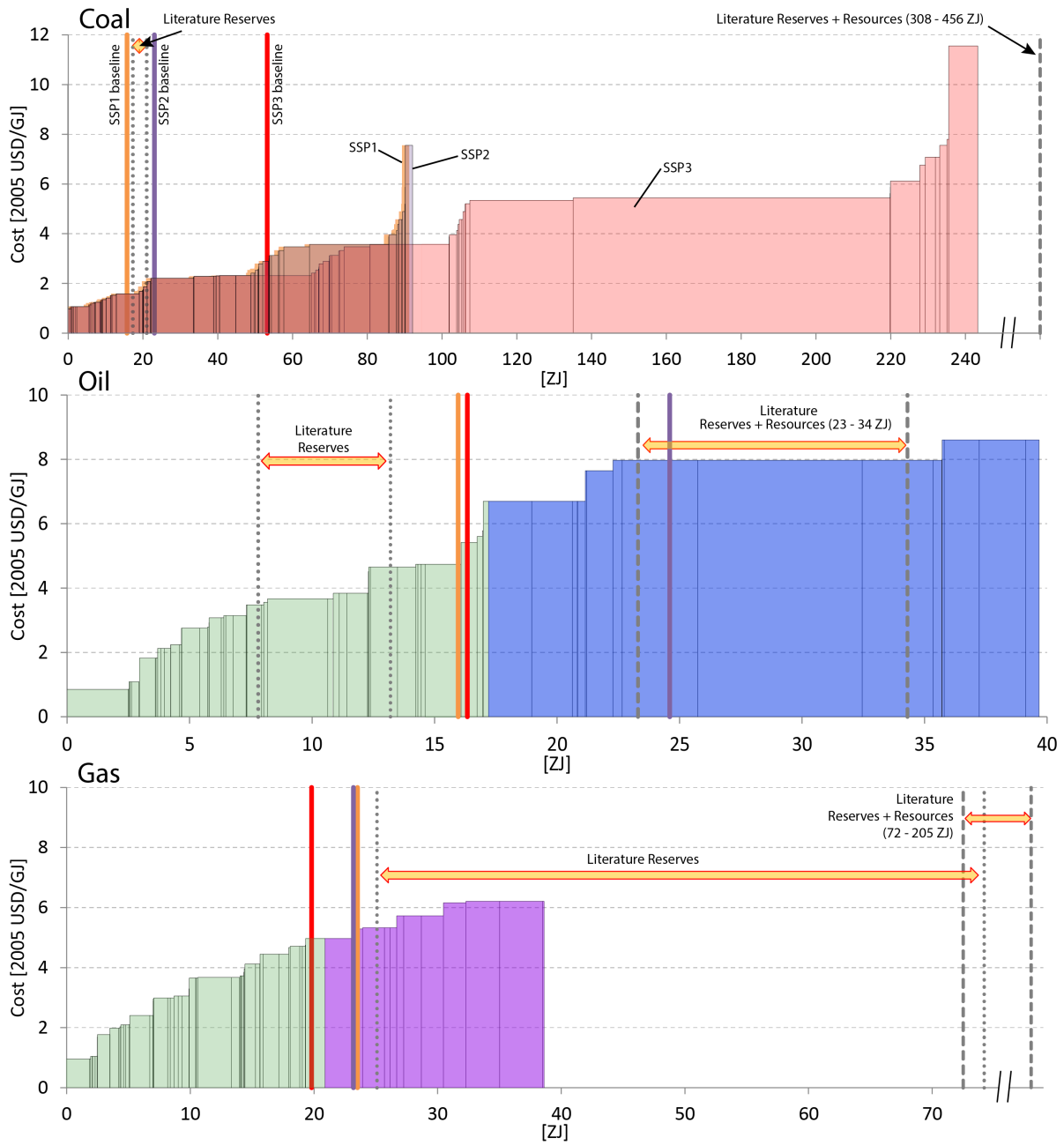

Fig. 3.1: Cumulative global resource supply curves for coal (top), oil (middle), and gas (bottom) in the IIASA IAM framework (Fricko et al., 2017 [[17]]).

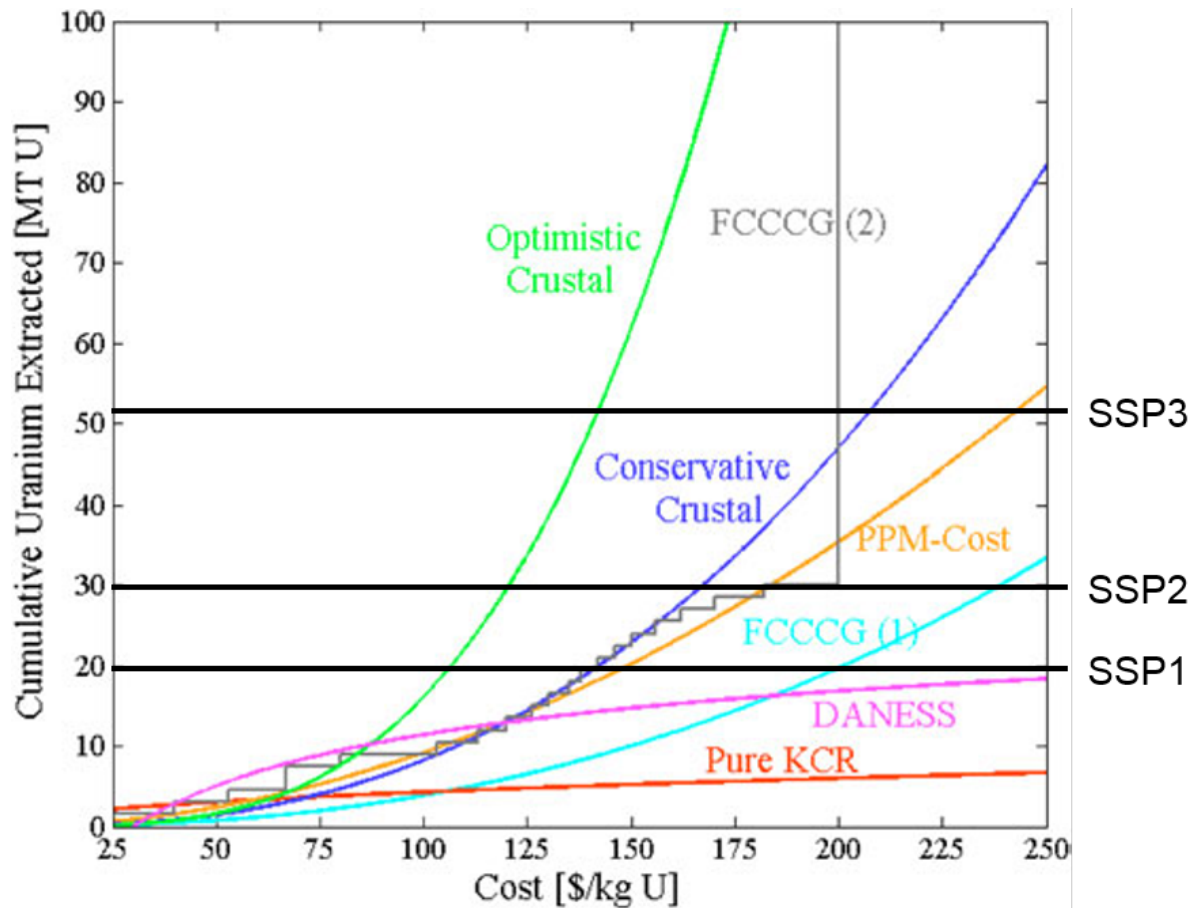

Fig. 3.2: Global uranium resources in the MESSAGE interpretation of the SSPs compared to seven supply curves from a literature review (Schneider and Sailor, 2008 [[96]]). Conservative Crustal and Optimistic Crustal refer to simple crustal models of uranium distribution in the crust and the of extraction costs on the concentration. Pure-KCR refers to a fit of a simple crustal model to known conventional resources (KCR) as estimated by the Red Book 2003 (OECD/NEA, 2004 [[112]]). PPM-Cost over the simple crustal models include a relationship between uranium grade and extraction costs. FCCCG(1) and (2) as well as DANESS refer to estimats from more complicated models of the dependency of extraction costs on uranium concentration (and therefore resource grade).

3.1.3 Non-Biomass Renewable Resources

Table 3.3 shows the assumed total potentials of non-biomass renewable energy deployment (by resource type) in the MESSAGE model. In addition, the technical potential estimates are based on different sources, such as the U.S. National Renewable Energy Laboratory [database](#) as described in the Global Energy Assessment (Rogner et al., 2012 [[90]]). In this context, it is important to note that typical MESSAGE scenarios do not consider the full technical potential of renewable energy resources, but rather only a subset of those potentials, owing to additional constraints (e.g., sustainability criteria, technology diffusion and systems integration issues, and other economic considerations). These constraints may lead to a significant reduction of the technical potential.

Table 3.3: Assumed global non-biomass renewable energy deployment potentials in the MESSAGE model. Estimates from the Global Energy Assessment (Rogner et al., 2012 [90]) also added for comparison.

Source	MESSAGE	Rogner et al., 2012 [[90]]
	Deployment Potential [EJ/yr]	Technical Potential [EJ/yr]
Hydro	38	50 - 60
Wind (on-/offshore)	689/287	1250 - 2250
Solar PV	6064	62,000 - 280,000
CSP	2132	same as Solar PV above
Geothermal	23	810 - 1400

Notes: MESSAGE renewable energy potentials are estimated based on the methods explained in Pietzcker et al., 2014 [[72]], Eurek et al., 2017 [[13]], Christiansson, 1995 [[6]], and Rogner et al., 2012 [[90]]. The potentials for non-combustible renewable energy sources are specified in terms of the electricity or heat that can be produced by specific technologies (i.e., from a secondary energy perspective). By contrast, the technical potentials from [[90]] refer to the flows of energy that could become available as inputs for technology conversion. So for example, the technical potential for wind is given as the kinetic energy available for wind power generation, whereas the deployment potential would only be the electricity that could be generated by the wind turbines.

Regional resource potentials for solar and wind are classified according to resource quality (annual capacity factor) based on Pietzcker et al. (2014, [[72]]) and Eurek et al. (2017) [[13]]. Regional resource potentials as implemented into MESSAGE are provided by region and capacity factor for solar PV, concentrating solar power (CSP), and onshore/offshore wind in Johnson et al. (2016, [[38]]). The physical potential of these sources is assumed to be the same across all SSPs. Table 3.4, Table 3.5, Table 3.6, Table 3.8 show the resource potential for solar PV, CSP (solar multiples (SM) of 1 & 3), on- and offshore wind respectively. For wind, Table 3.7 and Table 3.9 list the capacity factors corresponding to the wind classes used in the resource tables. It is important to note that part of the resource that is useable at economically competitive costs is assumed to differ widely (see Section *Electricity*).

Table 3.4: Resource potential (EJ) by region and capacity factor for solar photovoltaic (PV) technology (Johnson et al., 2016 [38]). For a description of each of the regions represented in the table, see Regions.

		By grade							
Capacity Factor (fraction of year)		0.28	0.21	0.20	0.19	0.18	0.17	0.15	0.14
Re- source Poten- tial (EJ)	AFR	0.0	1.1	46.5	176.6	233.4	218.2	169.9	61.9
	CPA	0.0	0.0	0.0	10.3	194.3	315.5	159.4	41.9
	EEU	0.0	0.0	0.0	0.0	0.0	0.0	0.1	1.0
	FSU	0.0	0.0	0.0	0.2	2.8	23.6	94.9	116.6
	LAM	0.1	4.9	49.4	165.6	157.5	167.4	81.4	48.5
	MEA	0.2	3.1	100.8	533.6	621.8	310.1	75.3	14.5
	NAM	0.0	0.3	24.3	140.4	131.0	116.3	155.7	106.4
	PAO	0.0	0.0	0.1	2.2	53.1	226.4	311.2	158.9
	PAS	0.0	0.0	0.0	0.2	0.8	17.0	31.2	12.8
	SAS	0.0	0.0	6.1	42.7	67.2	82.3	23.7	4.1
	WEU	0.0	0.1	0.2	3.0	12.8	39.4	58.3	33.3
	Global	0.3	9.6	227.4	1074.7	1474.6	1516.3	1160.9	600.0

Table 3.5: Resource potential (EJ) by region and capacity factor for concentrating solar power (CSP) technologies with solar multiples (SM) of 1 and 3 (Johnson et al., 2016 [38]).

		By grade							
Capacity Factor (frac- tion of year)	SM1	0.27	0.25	0.23	0.22	0.20	0.18	0.17	0.15
	SM3	0.75	0.68	0.64	0.59	0.55	0.50	0.46	0.41
Re- source Poten- tial (EJ)	AFR	0.0	3.6	19.0	81.6	106.7	62.8	59.6	37.8
	CPA	0.0	0.0	0.0	0.0	0.0	0.3	11.5	53.0
	EEU	0.0	0.0	0.0	0.0	0.0	0.0	0.0	0.0
	FSU	0.0	0.0	0.0	0.0	0.0	0.1	0.4	6.1
	LAM	0.0	2.0	7.0	11.8	29.3	57.1	56.8	53.5
	MEA	0.1	3.7	24.8	122.4	155.3	144.5	68.4	34.0
	NAM	0.0	0.0	0.0	6.3	19.7	20.2	29.6	43.2
	PAO	0.0	3.0	75.1	326.9	158.3	140.4	40.2	10.2
	PAS	0.0	0.0	0.0	0.0	0.0	0.0	0.1	0.6
	SAS	0.0	0.0	0.0	0.1	3.9	8.7	16.1	9.8
	WEU	0.0	0.0	0.0	0.0	0.2	0.7	2.4	3.0
	Global	0.1	12.3	126.0	549.2	473.3	434.8	285.0	251.3

Table 3.6: Resource potential (EJ) by region and wind class for onshore wind (Johnson et al., 2016 [38]).

	Wind Class					
	3	4	5	6	7	8+
AFR	38.2	21.3	13.4	6.8	2.6	2.1
CPA	24.7	11.4	5.4	2.6	0.3	0.0
EEU	6.1	5.7	0.3	0.0	0.0	0.0
FSU	52.3	83.8	5.8	0.8	0.0	0.0
LAM	33.5	15.9	9.6	5.7	3.9	3.7
MEA	56.1	22.2	6.0	2.1	0.9	0.3
NAM	28.6	66.4	23.7	1.5	0.4	0.0
PAO	18.9	18.8	3.6	1.4	1.8	0.5
PAS	5.2	2.9	0.8	0.2	0.0	0.0
SAS	12.3	7.9	2.4	1.6	0.9	0.3
WEU	16.1	10.5	6.6	8.2	3.7	0.6
World	292.1	266.8	77.5	30.9	14.3	7.5

Table 3.7: Capacity factor by region and wind class for onshore wind (Johnson et al., 2016 [38]).

	Wind Class					
	3	4	5	6	7	8+
AFR	0.24	0.28	0.32	0.36	0.40	0.45
CPA	0.24	0.28	0.32	0.36	0.38	0.45
EEU	0.24	0.27	0.31	0.36	0.38	0.45
FSU	0.24	0.28	0.31	0.35	0.38	0.45
LAM	0.24	0.28	0.32	0.36	0.39	0.46
MEA	0.24	0.27	0.32	0.35	0.39	0.45
NAM	0.24	0.28	0.31	0.36	0.39	0.45
PAO	0.24	0.28	0.32	0.36	0.40	0.43
PAS	0.24	0.27	0.32	0.35	0.40	0.45
SAS	0.24	0.27	0.32	0.36	0.39	0.42
WEU	0.24	0.28	0.32	0.36	0.39	0.43

Table 3.8: Resource potential (EJ) by region and wind class for offshore wind (Johnson et al., 2016 [38]).

	Wind Class					
	3	4	5	6	7	8+
AFR	3.1	2.4	2.0	2.0	1.1	1.7
CPA	3.5	4.3	2.6	0.9	1.3	0.1
EEU	0.7	0.6	1.0	0.0	0.0	0.0
FSU	1.8	4.6	14.2	13.3	4.3	0.7
LAM	7.1	7.3	5.3	2.7	2.6	5.9
MEA	3.2	0.9	0.8	0.9	0.6	0.9
NAM	4.5	18.2	24.0	16.0	7.3	2.1
PAO	5.8	11.2	15.3	9.8	2.6	2.5
PAS	5.3	6.6	4.7	1.5	0.1	0.0
SAS	1.9	0.9	0.6	0.5	0.0	0.0
WEU	3.5	4.7	8.8	12.9	10.3	0.9
World	40.4	61.5	79.4	60.5	30.3	14.8

Table 3.9: Capacity factor by region and wind class for offshore wind (Johnson et al., 2016 [38]).

	Wind class					
	3	4	5	6	7	8+
AFR	0.24	0.28	0.32	0.36	0.41	0.47
CPA	0.24	0.28	0.32	0.36	0.40	0.42
EEU	0.24	0.29	0.32	0.34	0.40	0.42
FSU	0.25	0.28	0.32	0.35	0.39	0.43
LAM	0.24	0.28	0.32	0.36	0.40	0.49
MEA	0.24	0.28	0.32	0.36	0.40	0.45
NAM	0.25	0.28	0.32	0.36	0.40	0.43
PAO	0.24	0.28	0.32	0.36	0.40	0.47
PAS	0.24	0.28	0.32	0.35	0.39	0.42
SAS	0.24	0.27	0.32	0.36	0.40	0.42
WEU	0.24	0.28	0.32	0.36	0.40	0.42

3.1.4 Biomass Resources

Biomass energy is another potentially important renewable energy resource in the MESSAGE model. This includes both commercial and non-commercial use. Commercial refers to the use of bioenergy in, for example, power plants or biofuel refineries, while non-commercial refers to the use of bioenergy for residential heating and cooking, primarily in rural households of today's developing countries. Bioenergy potentials are derived from the GLOBIOM model and differ across SSPs as a result of different levels of competition over land for food and fibre, but ultimately only vary to a limited degree (Fig. 3.3). The drivers underlying this competition are different land-use developments in the SSPs, which are determined by agricultural productivity and global demand for food consumption. (Fricko et al., 2017 [[17]])

3.2 Energy conversion

Energy technologies are characterized by numerical model inputs describing their economic (e.g., investment costs, fixed and variable operation and maintenance costs), technical (e.g., conversion efficiencies), ecological (e.g., GHG and air pollutant emissions), and sociopolitical characteristics. An example for the sociopolitical situation in a world region would be the decision by a country or world region to ban certain types of technologies (e.g., nuclear power plants). Model input data reflecting this situation would be constraining the use of these technologies or, equivalently, their omission from the data set for this region altogether.

Each energy conversion technology is characterized in MESSAGE by the following data:

- Energy inputs and outputs together with the respective conversion efficiencies. Most energy conversion technologies have one energy input and one output and thereby one associated efficiency. But technologies may also use different fuels (either jointly or alternatively), may have different operation modes and different outputs, which also may have varying shares. An example of different operation modes would be a passout turbine, which can generate electricity and heat at the same time when operated in co-generation mode or which can produce electricity only. For each technology, one output and one input are defined as main output and main input respectively. The activity variables of technologies are given in the units of the main input consumed by the technology or, if there is no explicit input (as for solar-energy conversion technologies), in units of the main output.
- Specific investment costs (e.g., per kilowatt, kW) and time of construction as well as distribution of capital costs over construction time.
- Fixed operating and maintenance costs (per unit of capacity, e.g., per kW).
- Variable operating costs (per unit of output, e.g. per kilowatt-hour, kWh, excluding fuel costs).
- Plant availability or maximum utilization time per year. This parameter also reflects maintenance periods and other technological limitations that prevent the continuous operation of the technology.

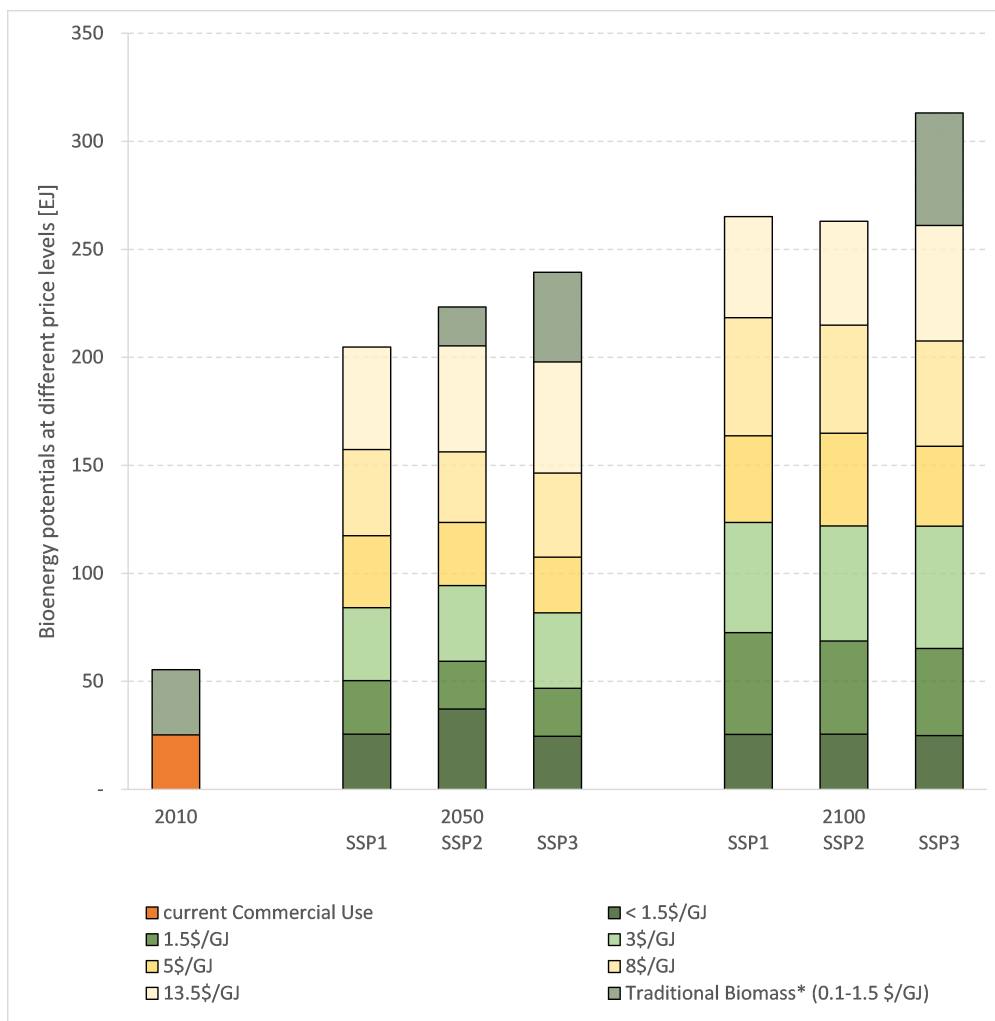

Fig. 3.3: Global bioenergy potential. Availability of bioenergy at different price levels in the MESSAGE-GLOBIOM model for the three SSPs (Fricko et al., 2017 [[17]]). Typically non-commercial biomass is not traded or sold, however in some cases there is a market – prices range from 0.1-1.5\$/GJ (Pachauri et al., 2013 [[68]]) (\$ equals 2005 USD).

- Technical lifetime of the conversion technology in years.
- Year of first commercial availability and last year of commercial availability of the technology.
- Consumption or production of certain materials (e.g. emissions of kg of CO₂ or SO₂ per produced kWh).
- Limitations on the (annual) activity and on the installed capacity of a technology.
- Constraints on the rate of growth or decrease of the annually new installed capacity and on the growth or decrease of the activity of a technology.
- Technical application constraints, e.g., maximum possible shares of wind or solar power in an electricity network without storage capabilities.
- Inventory upon startup and shutdown, e.g., initial nuclear core needed at the startup of a nuclear power plant.
- Lag time between input and output of the technology.
- Minimum unit size, e.g. for nuclear power plants it does not make sense to build plants with a capacity of a few kilowatt power (optional, not used in current model version).
- Sociopolitical constraints, e.g., ban of nuclear power plants.
- Inconvenience costs which are specified only for end-use technologies (e.g. cook stoves)

The specific technologies represented in various parts of the energy conversion sector are discussed in the following sections on *Electricity*, *Heat*, *Other conversion* and *Grid, Infrastructure and System Reliability*.

3.2.1 Electricity

MESSAGE covers a large number of electricity generation options utilizing a wide range of primary energy sources. For fossil-based electricity generation technologies, typically a number of different technology variants with different efficiencies, environmental characteristics and costs are represented. For example, in the case of coal, MESSAGE distinguishes subcritical and supercritical pulverized coal (PC) power plants where the subcritical variant is available with and without flue gas desulfurization/denox and one internal gasification combined cycle (IGCC) power plant. The supercritical PC and IGCC plants are also available with carbon capture and storage (CCS) which also can be retrofitted to some of the existing PC power plants (see Fig. 3.4). Table 3.10 below shows the different power plant types represented in MESSAGE.

Four different nuclear power plant types are represented in MESSAGE, i.e. two light water reactor types, a fast breeder reactor and a high temperature reactor, but only the two light water types are included in the majority of scenarios being developed with MESSAGE in the recent past. In addition, MESSAGE includes a representation of the nuclear fuel cycle, including reprocessing and the plutonium fuel cycle, and keeps track of the amounts of nuclear waste being produced.

The conversion of five renewable energy sources to electricity is represented in MESSAGE (see Fig. 3.5). For wind power, both on- and offshore electricity generation are covered and for solar energy, photovoltaics (PV) and solar thermal (concentrating solar power, CSP) electricity generation are included in MESSAGE (see also sections on *Non-Biomass Renewable Resources* and *Systems Integration and Reliability*). Two CSP technologies are modeled: (1) a flexible plant with a solar multiple of one (SM1) and 6 h of thermal storage and (2) a baseload plant with a solar multiple of three (SM3) and 12 h of storage (Johnson et al. 2016, [[38]]).

Most thermal power plants offer the option of coupled heat production (CHP, see Table 3.10). This option is modeled as a passout turbine via a penalty on the electricity generation efficiency. In addition to the main electricity generation technologies described in this section, also the co-generation of electricity in conversion technologies primarily devoted to producing non-electric energy carriers (e.g., synthetic liquid fuels) is included in MESSAGE (see section on *Other conversion*).

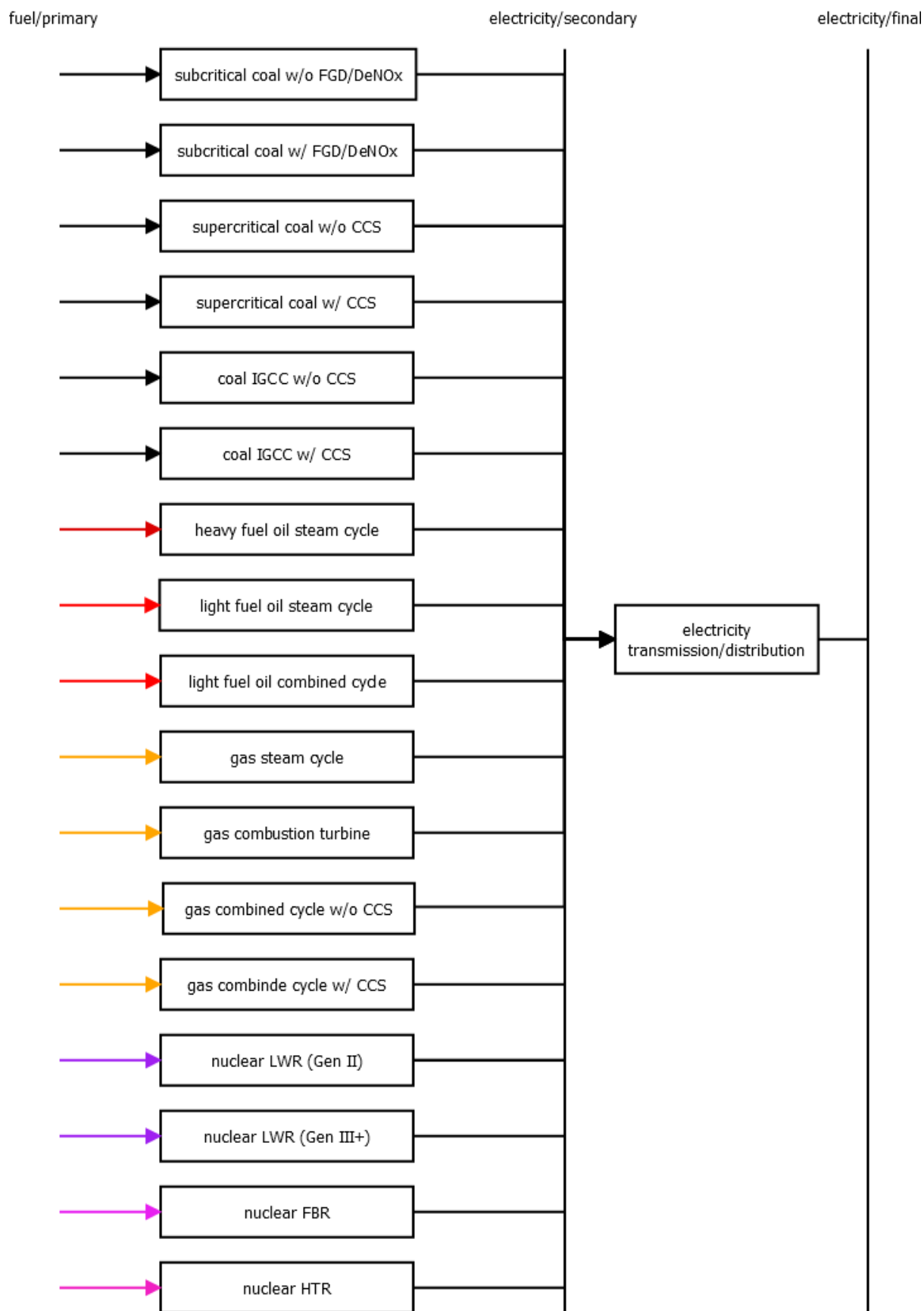

Fig. 3.4: Schematic diagram of the fossil and nuclear power plants represented in MESSAGEix.

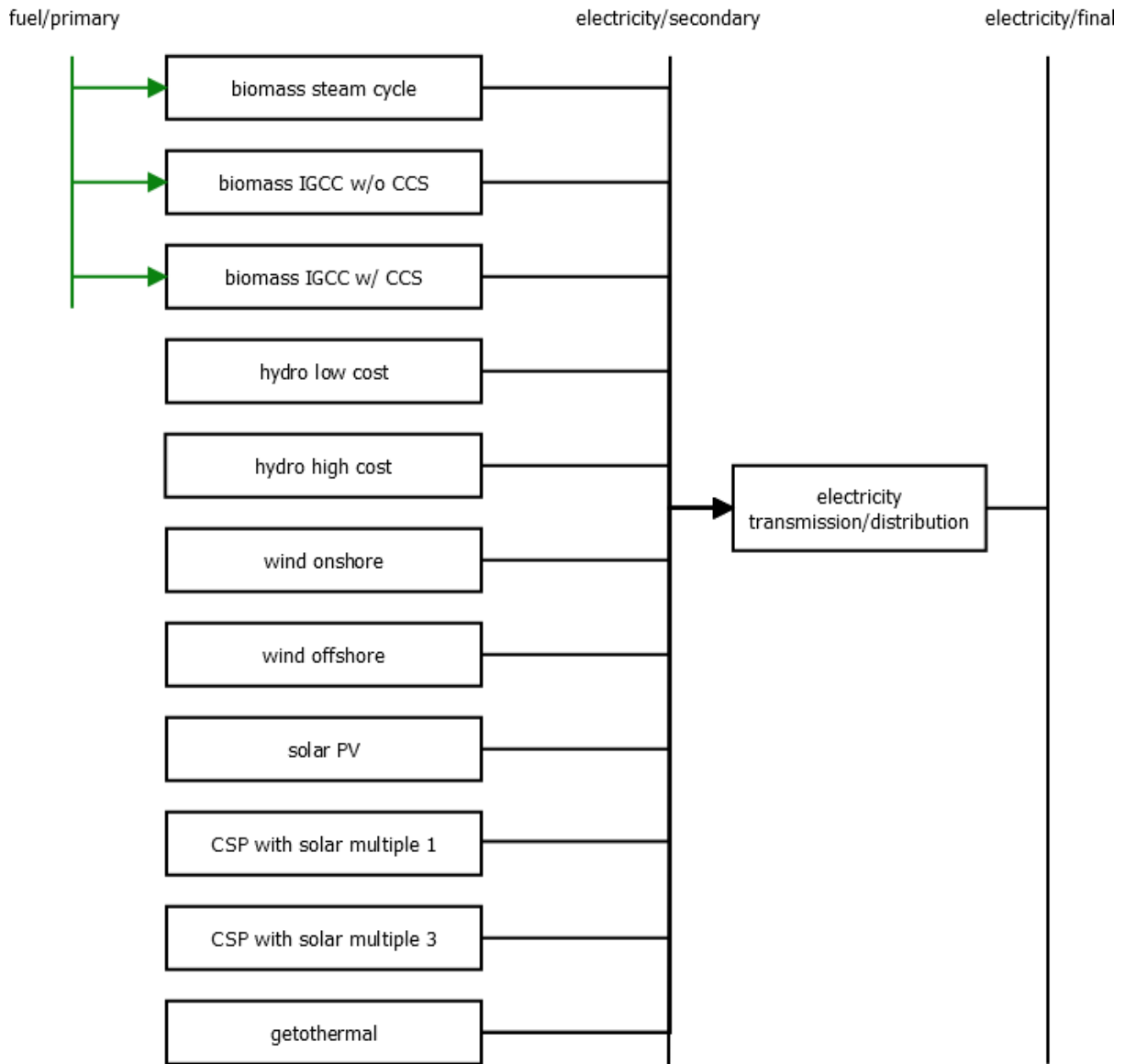

Fig. 3.5: Schematic diagram of the renewable power generation options represented in MESSAGEix.

Table 3.10: List of electricity generation technologies represented in MESSAGE-GLOBIOM by energy source.

Energy source	Technology	CHP option
coal	subcritical PC power plant without desulphurization/denox	yes
	subcritical PC power plant with desulphurization/denox	yes
	supercritical PC power plant with desulphurization/denox	yes
	supercritical PC power plant with desulphurization/denox and CCS	yes
	IGCC power plant	yes
	IGCC power plant with CCS	yes
oil	heavy fuel oil steam power plant	yes
	light fuel oil steam power plant	yes
	light fuel oil combined cycle power plant	yes
gas	gas steam power plant	yes
	gas combustion turbine gas	yes
	combined cycle power plant	yes
	combined cycle power plant with CCS	yes
nuclear	nuclear light water reactor (Gen II)	yes
	nuclear light water reactor (Gen III+)	yes
	fast breeder reactor	
	high temperature reactor	
biomass	biomass steam power plant	yes
	biomass IGCC power plant	yes
	biomass IGCC power plant with CCS	yes
hydro	hydro power plant (2 cost categories)	no
wind	onshore wind turbine	no
	offshore wind turbine	no
solar	solar photovoltaics (PV)	no
	concentrating solar power (CSP) with a solar multiple of 1 (SM1)	no
	concentrating solar power (CSP) with a solar multiple of 3 (SM3)	no
geothermal	geothermal power plant	yes

In Fig. 3.6, the black ranges show historical cost ranges for 2005. Green, blue, and red ranges show cost ranges in 2100 for SSP1, SSP2, and SSP3, respectively (see description of the *SSP narratives*). Global values are represented by solid ranges. Values in the global South are represented by dashed ranges. The diamonds show the costs in the “North America” region (Fricko et al., 2017 [[17]]).

In Fig. 3.7, the black ranges show historical cost ranges for 2005. Green, blue, and red ranges show cost ranges in 2100 for SSP1, SSP2, and SSP3, respectively. Global values are represented by solid ranges. Values in the global South are represented by dashed ranges. The diamonds show the costs in the “North America” region. PV – Photovoltaic (Fricko et al., 2017 [[17]]).

3.2.2 Heat

A number centralized district heating technologies based on fossil and renewable energy sources are represented in MESSAGE (see Table 3.11). Similar to coupled heat and power (CHP) technologies that are described in the *Electricity* sector, these heating plants feed low temperature heat into the district heating system that is then used in the end-use sectors. In addition, there are (decentralized) heat generation options in the *Industrial sector* and *Residential and commercial sectors*.

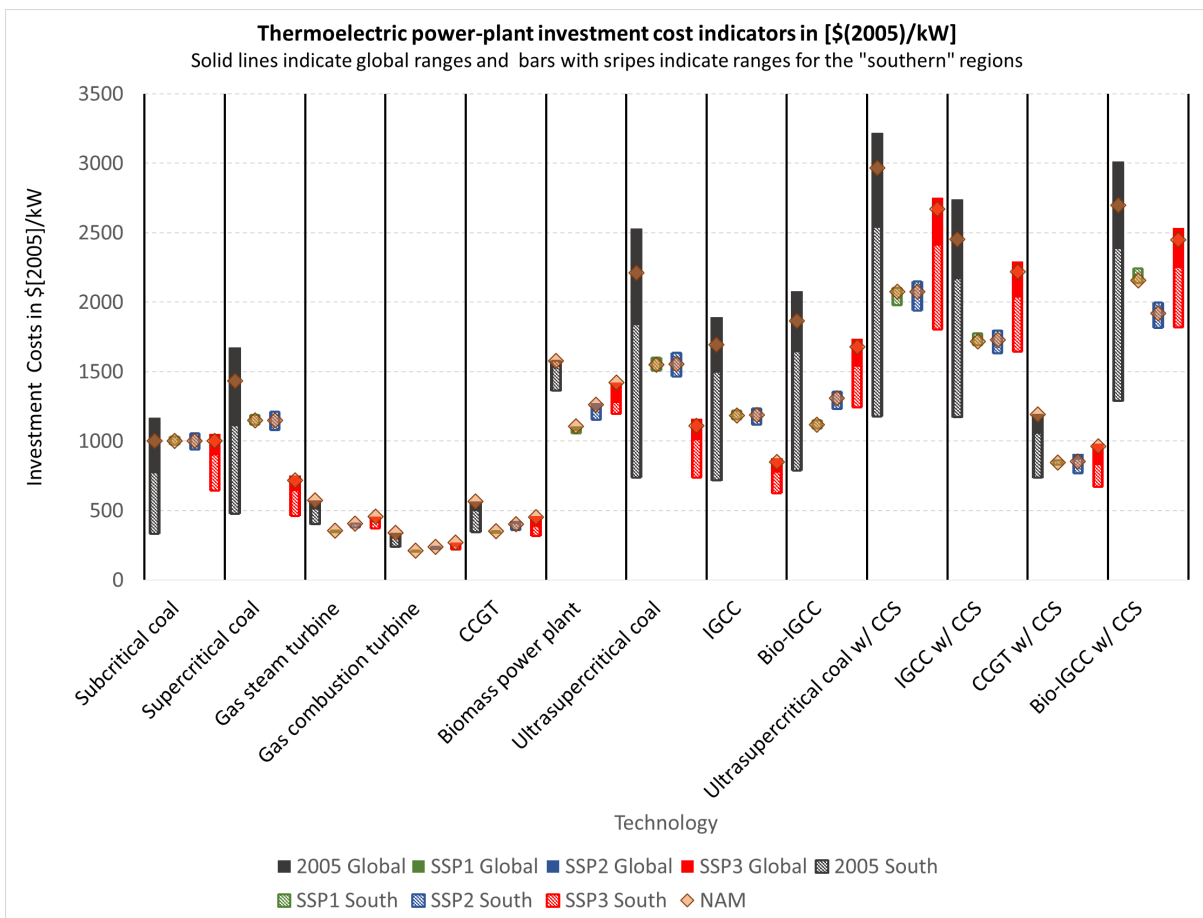

Fig. 3.6: Cost indicators for thermoelectric power-plant investment (Fricko et al., 2017 [[17]]).

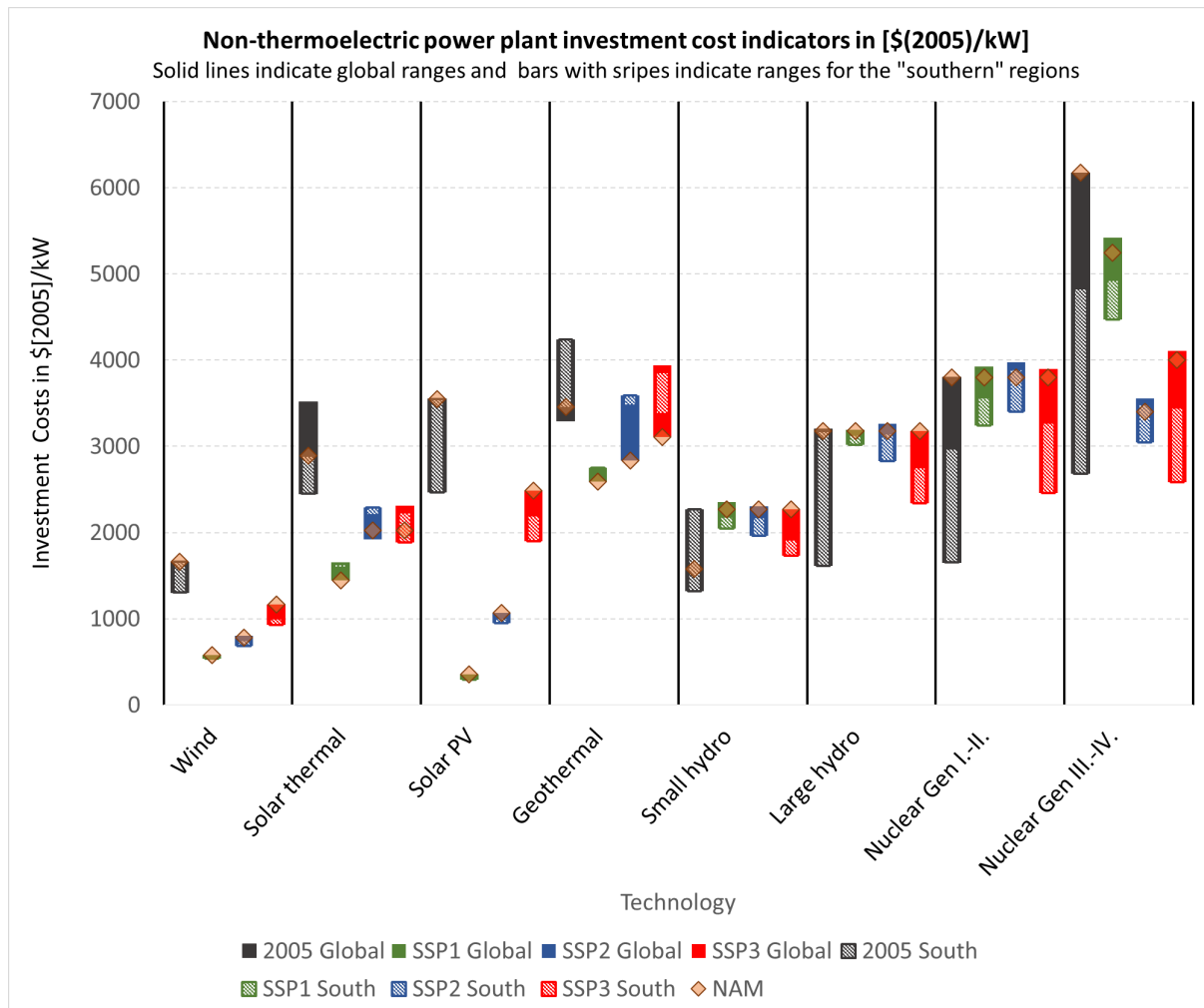

Fig. 3.7: Cost indicators for non-thermoelectric power-plant investment (Fricko et al., 2017 [[17]]). Abbreviations: CCS – Carbon Capture and Storage; IGCC – Integrated gasification combined cycles; ST – Steam turbine; CT – Combustion turbine; CCGT – Combined cycle gas turbine

Table 3.11: List of centralized heat generation technologies represented in MESSAGE by energy source.

Energy Source	Technology
coal	coal district heating plant
oil	light fuel oil district heating plant
gas	gas district heating plant
biomass	solid biomass district heating plant
geothermal	geothermal district heating plant

3.2.3 Other conversion

Beyond electricity and centralized heat generation there are three further subsectors of the conversion sector represented in MESSAGE, liquid fuel production, gaseous fuel production and hydrogen production. Fig. 3.8 provides an overview of the investment cost ranges for these conversion technologies. The black bars show historical cost ranges for 2005. Green, blue, and red bars show cost ranges in 2100 for SSP1, SSP2, and SSP3, respectively. Global values are represented by solid ranges. Values in the global South are represented by dashed ranges. The diamonds show the costs in the “North America” region.

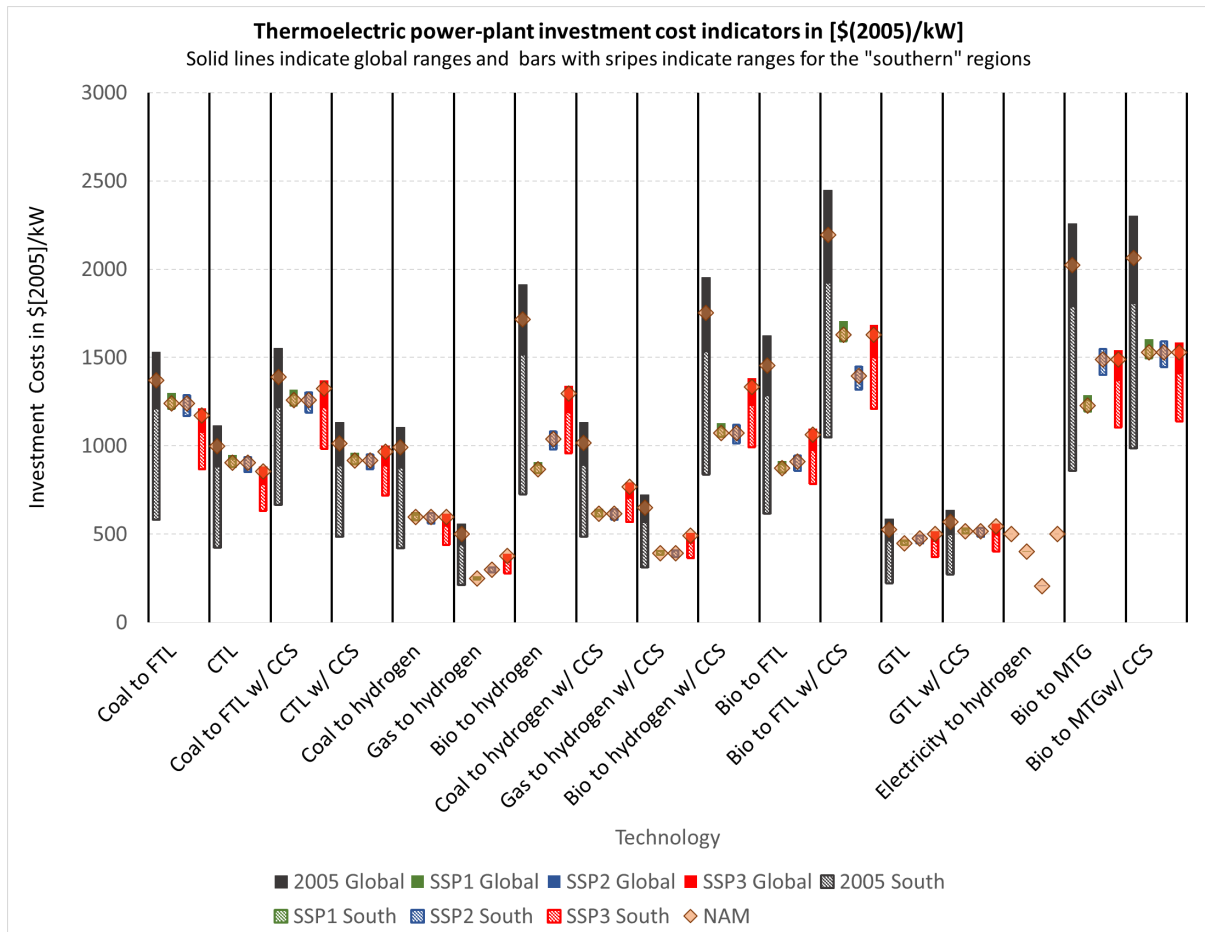

Fig. 3.8: Cost indicators for other conversion technology investment (Fricko et al., 2017 [[17]]) Abbreviations: CCS – Carbon capture and storage; CTL – Coal to liquids; GTL – Gas to liquids; BTL – Biomass to liquids.

Liquid Fuel Production

Apart from oil refining as predominant supply technology for liquid fuels at present a number of alternative liquid fuel production routes from different feedstocks are represented in MESSAGE (see Table 3.12). Different processes for coal liquefaction, gas-to-liquids technologies and biomass-to-liquids technologies both with and without CCS are covered. Some of these technologies include co-generation of electricity, for example, by burning unconverted syngas from a Fischer-Tropsch synthesis in a gas turbine (c.f. Larson et al., 2012 [[47]]). Technology costs for the synthetic liquid fuel production options are based on Larson et al. (2012) [[47]].

Table 3.12: Liquid fuel production technologies in MESSAGE by energy source.

Energy Source	Technology	Electricity cogeneration
biomass	Fischer-Tropsch biomass-to-liquids	yes
	Fischer-Tropsch biomass-to-liquids with CCS	yes
	Gasoline via the Methanol-to-Gasoline (MTG) Process	yes
	Gasoline via the Methanol-to-Gasoline (MTG) Process with CCS	yes
coal	Fischer-Tropsch coal-to-liquids	yes
	Fischer-Tropsch coal-to-liquids with CCS	yes
	coal methanol-to-gasoline	yes
	coal methanol-to-gasoline with CCS	yes
gas	Fischer-Tropsch gas-to-liquids	no
	Fischer-Tropsch gas-to-liquids with CCS	no
oil	simple refinery	no
	complex refinery	no

Gaseous Fuel Production

Gaseous fuel production technologies represented in MESSAGE are gasification of solids including coal and biomass. In both cases carbon capture and storage (CCS) can be combined with the gasification process to capture to a good part the carbon that is not included in the synthetically produced methane. Table 3.13 provides a listing of all gaseous fuel production technologies.

Table 3.13: Gaseous fuel production technologies in MESSAGE by energy source.

Energy Source	Technology
biomass	biomass gasification
coal	coal gasification

Hydrogen Production

A number of hydrogen production options are represented in MESSAGE. These include gasification processes for coal and biomass, steam methane reforming from natural gas and hydrogen electrolysis. The fossil fuel and biomass based options can be combined with CCS to reduce carbon emissions. Table 3.14 provides a full list of hydrogen production technologies.

Table 3.14: Hydrogen production technologies in MESSAGE by energy source.

Energy source	Technology	Electricity cogeneration
coal	coal gasification	yes
	coal gasification with CCS	yes
biomass	biomass gasification	yes
	biomass gasification with CCS	yes
gas	steam methane reforming	yes
	steam methane reforming with CCS	no
electricity	electrolysis	no

3.2.4 Grid, Infrastructure and System Reliability

Energy Transmission and Distribution Infrastructure

Energy transport and distribution infrastructure is included in MESSAGE at a level relevant to represent the associated costs as well as transmission and distribution losses. Within individual model regions the capital stock of transmission and distribution infrastructure and its turnover is modeled for the following set of energy carriers:

- electricity
- district heat
- natural gas
- hydrogen

For all solid (coal, biomass) and liquid energy carriers (oil products, biofuels, fossil syngas) a simpler approach is taken and only transmission and distribution losses and costs are taken into account.

Inter-regional energy transmission infrastructure, such as natural gas pipelines and high voltage electricity grids, are also represented between geographically adjacent regions. Solid and liquid fuel trade is, similar to the transmission and distribution within regions, modeled by taking into account distribution losses and costs. A special case are gases that can be traded in liquified form, i.e. liquified natural gas (LNG) and liquid hydrogen, where liquefaction and re-gasification infrastructure is explicitly represented in addition to the actual transport process.

Systems Integration and Reliability

The global MESSAGE model includes a single annual time period within each modeling year characterized by average annual load and 11 geographic regions. Seasonal and diurnal load curves and spatial issues such as transmission constraints or renewable resource heterogeneity are treated in a stylized way in the model. The mechanism to represent power system reliability in MESSAGE is based on (Sullivan et al., 2013 [[103]]). This method elevates the stylization of temporal resolution by introducing two concepts, peak reserve capacity and general-timescale flexibility (for mathematical representation see this Section). To represent capacity reserves in MESSAGE, a requirement is defined that each region build sufficient firm generating capacity to maintain reliability through reasonable load and contingency events. As a proxy for complex system reliability metrics, a reserve margin-based metric was used, setting the capacity requirement at a multiple of average load, based on electric-system parameters. While many of the same issues apply to both electricity from wind and solar energy, the description below focuses on wind.

Toward meeting the firm capacity requirement, conventional generating technologies contribute their nameplate generation capacity while variable renewables contribute a capacity value that declines as the market share of the technology increases. This reflects the fact that wind and solar generators do not always generate when needed, and that

their output is generally self-correlated. In order to adjust wind capacity values for different levels of penetration, it was necessary to introduce a stepwise-linear supply curve for wind power (shown in the Fig. 3.9 below). Each bin covers a range of wind penetration levels as fraction of load and has discrete coefficients for the two constraints. The bins are predefined, and therefore are not able to allow, for example, resource diversification to increase capacity value at a given level of wind penetration.

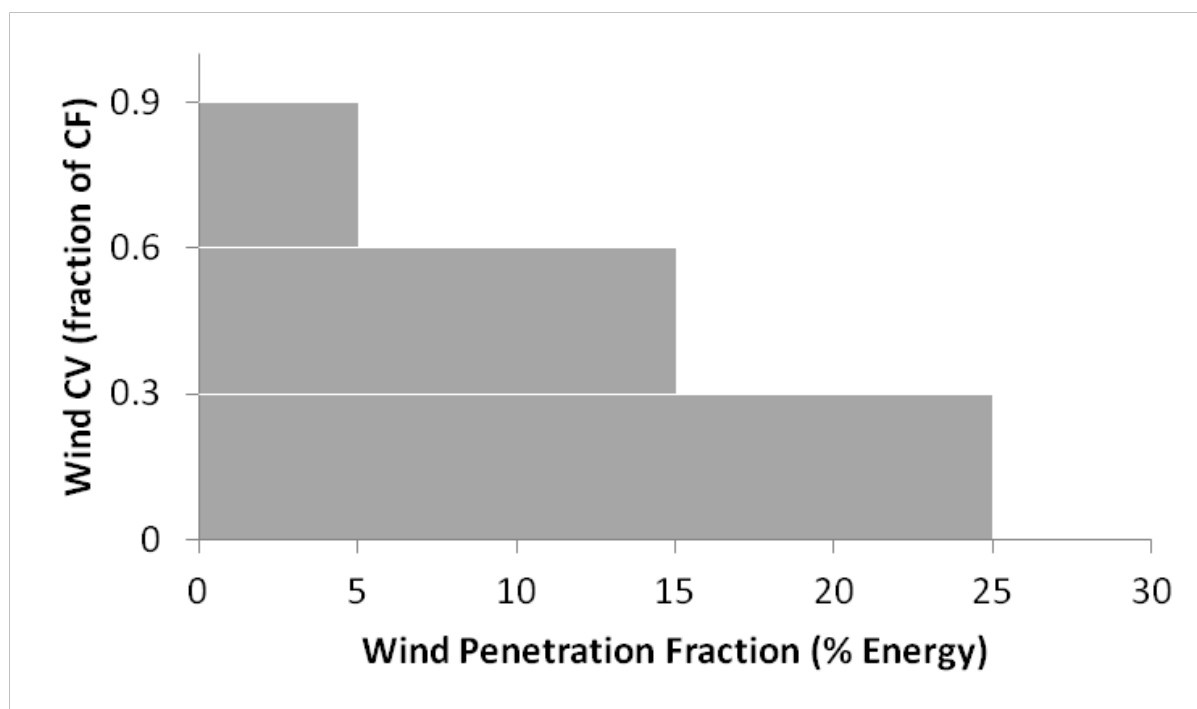

Fig. 3.9: Parameterization of Wind Capacity Value.

The capacity value bins are independent of the wind supply curve bins that already existed in MESSAGE, which are based on quality of the wind resource. That supply curve is defined by absolute wind capacity built, not fraction of load; and the bins differ based on their annual average capacity factor, not capacity value. Solar PV is treated in a similar way as wind with the parameters obviously being different ones. In contrast, concentrating solar power (CSP) is modeled very much like dispatchable power plants in MESSAGE, because it is assumed to come with several hours of thermal storage, making it almost capable of running in baseload mode.

In order to ensure adequate reserve dispatch, dynamic shadow prices are placed on capacity investments of intermittent technologies (e.g., wind and solar). The prices are a function of the cumulative installed capacity of the intermittent technologies, the ability for the conventional power supply to act as reserve dispatch, and the demand-side reliability requirements. For instance, a large amount of storage capacity should, all else being equal, lower the shadow price for additional wind. Conversely, an inflexible, coal- or nuclear-heavy generating base should increase the cost of investment in wind by demanding additional expenditures in the form of natural gas combustion turbines or storage or improved demand-side management to maintain system reliability.

Starting from the energy metric used in MESSAGE (electricity is considered as annual average load; there are no time-slices or load-curves), the flexibility requirement uses MWh of generation as its unit of note. The metric is inherently limited because operating reserves are often characterized by energy not-generated: a natural gas combustion turbine (gas CT) that is standing by, ready to start-up at a moment's notice; a combined-cycle plant operating below its peak output to enable ramping in the event of a surge in demand. Nevertheless, because there is generally a portion of generation associated with providing operating reserves (e.g. that on-call gas CT plant will be called some fraction of the time), it is posited that using generated energy to gauge flexibility is a reasonable metric considering the simplifications that need to be made. Furthermore, ancillary services associated with ramping and peaking often do involve real energy generation, and variable renewable technologies generally increase the need for ramping.

Electric-sector flexibility in MESSAGE is represented as follows: each generating technology is assigned a coefficient between -1 and 1 representing (if positive) the fraction of generation from that technology that is considered to be flexible or (if negative) the additional flexible generation required for each unit of generation from that technology. Load also has a parameter (a negative one) representing the amount of flexible energy the system requires solely

to meet changes and uncertainty in load. Table 3.15 below displays the parameters that were estimated using a unit-commitment model that commits and dispatches a fixed generation system at hourly resolution to meet load and ancillary service requirements while hewing to generator and transmission operation limitations (Sullivan et al., 2013 [[103]]). Technologies that were not included in the unit-commitment model (nuclear, hydrogen electrolysis, solar PV) have estimated coefficients.

Table 3.15: Flexibility Coefficients by Technology (Sullivan et al., 2013 [103]).

Technology	Flexibility Parameter
Load	-0.1
Wind	-0.08
Solar PV	-0.05
Geothermal	0
Nuclear	0
Coal	0.15
Biopower	0.3
Gas CC	0.5
Hydropower	0.5
H2 Electrolysis	0.5
Oil/Gas Steam	1
Gas CT	1
Electricity Storage	1

Thus, a technology like a natural gas combustion turbine, used almost exclusively for ancillary services, has a flexibility coefficient of 1, while a coal plant, which provides mostly bulk power but can supply some ancillary services, has a small, positive coefficient. Electric storage systems (e.g., pumped hydropower, compressed air storage, flow batteries) and flexible demand-side technologies like hydrogen-production contribute as well. Meanwhile, wind power and solar PV, which require additional system flexibility to smooth out fluctuations, have negative flexibility coefficients.

3.3 Energy end-use

MESSAGEix distinguishes three energy end-use sectors, i.e. transport, residential/commercial (also referred to as the buildings sector) and industry. Given the long-term nature of the scenarios, the model version used for the SSPs, represents these end-use sectors in a stylized way. For more detailed short-term analysis, a model version with a more detailed transport sector module that distinguishes different transport modes, vehicle classes and consumer types exists (McCollum et al., 2016 [[54]]).

3.3.1 Transport sector

The most commonly applied MESSAGEix transport sector representation is stylized and essentially includes fuel switching and price-elastic demands (via MACRO linkage) as the main responses to energy and climate policy (see Fig. 3.10).

In this stylized transport sector representation fuel switching is a key option to reduce emissions, i.e., different final energy forms that provide energy for transportation can be chosen from. In addition to the alternative energy carriers that serve as input to these stylized transportation options, their relative efficiencies are also different. The useful energy demand in the transportation sector is specified as internal combustion engine (ICE) equivalent demands which therefore by definition has a conversion efficiency of final to useful energy of 1. Relative to that the conversion efficiency of alternative fuels is higher, for example, electricity in 2010 has about a factor of three, higher final to useful efficiency than the regular oil-product based ICE. The overall efficiency improvements of the ICE in the transportation sector and modal switching over time is implicitly included in the demand specifications, coming from the scenario generator (see section on demand). Additional demand reduction in response to price increases in policy scenarios then occurs via the fuel switching option (due to the fuel-specific relative efficiencies) as well as via the linkage with the macro-economic model MACRO as illustrated in Fig. 3.10 below.

Limitations of switching to alternative fuels may occur for example as a result of restricted infrastructure availability (e.g., rail network) or some energy carriers being unsuitable for certain transport modes (e.g., electrification of aviation). To reflect these limitations, share constraints of energy carriers (e.g., electricity) and energy carrier groups (e.g., liquid fuels) are used in the transport sector. In addition, the diffusion speed of alternative fuels is limited to mimic bottlenecks in the supply chains, not explicitly represented in MESSAGEix (e.g., non-energy related infrastructure). Both the share as well as the diffusion constraints are usually parametrized based on transport sector studies that analyze such developments and their feasibility in much greater detail.

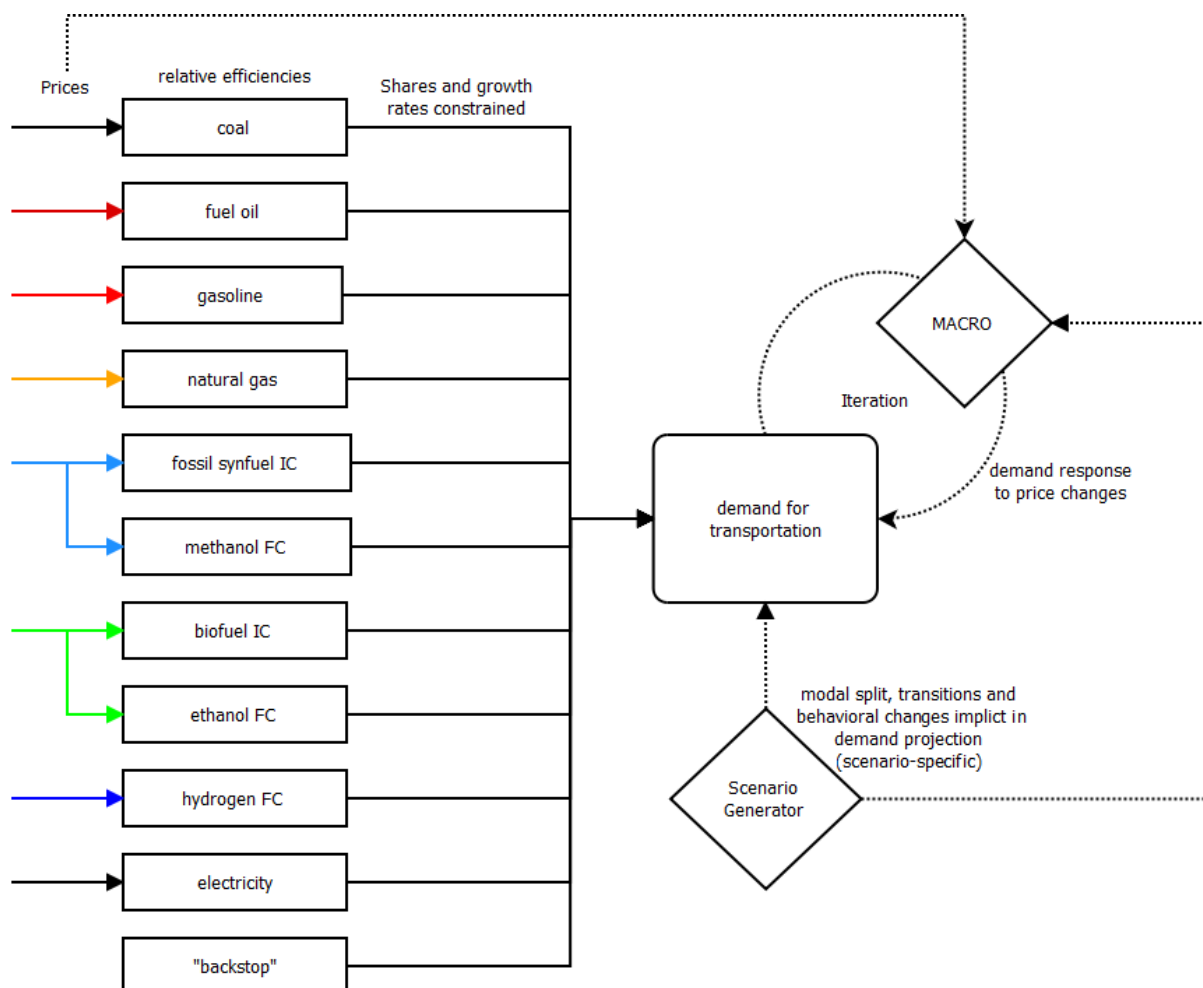

Fig. 3.10: Schematic diagram of the stylized transport sector representation in MESSAGEix.

The demand for international shipping is modeled in a simplified way with a number of different energy carrier options (light and heavy fuel oil, biofuels, natural gas, and hydrogen). The demand for international shipping is coupled to global GDP development with an income elasticity, but to date no demand response in mitigation scenarios is implemented.

Table 3.16 presents the quantitative translation of the the storyline elements of SSP1, SSP2 and SSP3 in terms of electrification rate for transport (Fricko et al., 2017 [[17]]).

Table 3.16: Electrification rate within transport for SSP1, SSP2 and SSP3 (Fricko et al., 2017 [17]). The indicators apply to 2010-2100; Intensity improvements are presented in Final Energy (FE)/GDP annually.

	SSP1	SSP2	SSP3
Transport	High electrification (max. 75% of total transport possible)	Medium electrification (max. 50% of total transport possible)	Low electrification (max. 10% of total transport possible)

3.3.2 Residential and commercial sectors

The residential and commercial sector in MESSAGEix distinguishes two demand categories, thermal and specific. Thermal demand, i.e., low temperature heat, can be supplied by a variety of different energy carriers while specific demand requires electricity (or a decentralized technology to convert other energy carriers to electricity).

The residential and commercial thermal energy demand includes fuel switching as the main option, i.e., different choices about final energy forms to provide thermal energy. In addition to the alternative energy carriers that serve as input to these thermal energy supply options, their relative efficiencies also vary. For example, solid fuels such as coal have lower conversion efficiencies than natural gas, direct electric heating or electric heat pumps. Additional demand reduction in response to price increases in policy scenarios is included via the fuel switching option (due to the fuel-specific relative efficiencies) as well as via the linkage with the macro-economic model MACRO (see Fig. 3.11 below). The specific residential and commercial demand can be satisfied either by electricity from the grid or with decentralized electricity generation options such as fuel cells and on-site CHP.

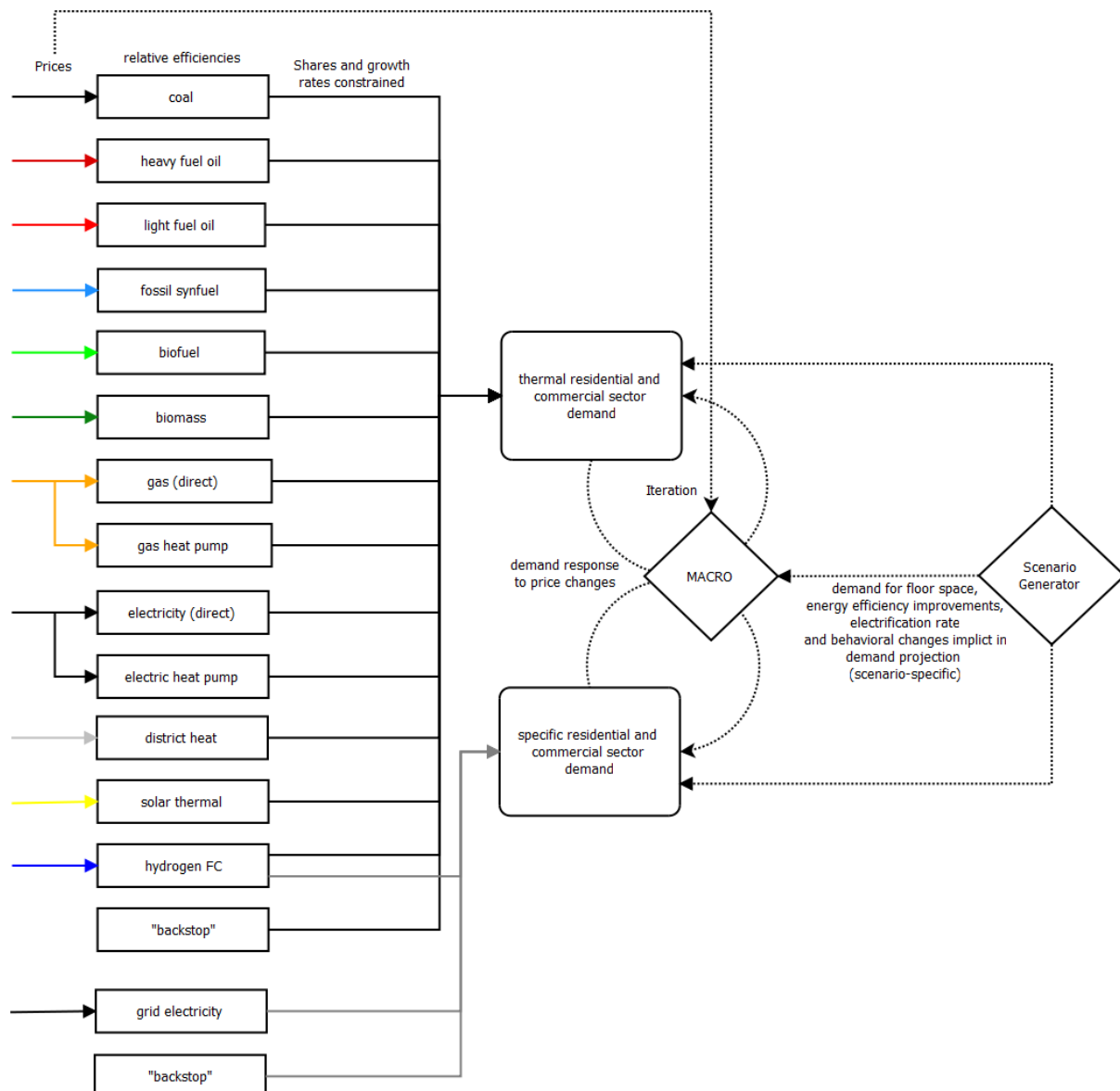

Fig. 3.11: Schematic diagram of the residential and commercial sector representation in MESSAGEix.

To reflect limitations of switching to alternative fuels, for example as a result of limited infrastructure availability (e.g., district heating network) or some energy carriers being unsuitable for certain applications, share constraints of energy carriers (e.g., electricity) and energy carrier groups (e.g., liquid fuels) are used in the residential and commercial sector. In addition, as in the transport sector, the diffusion speed of alternative fuels is limited to mimic bottlenecks

in the supply chains, not explicitly represented in MESSAGEix (e.g., non-energy related infrastructure).

Table 3.17 presents the quantitative translation of the the storyline elements of SSP1, SSP2 and SSP3 in terms of electrification rate for the residential and commercial sectors. These indicators apply to 2010-2100; Intensity improvements are in FE/GDP annually (Fricko et al., 2017 [[17]]).

Table 3.17: Electrification rate within the residential and commercial sectors for SSP1, SSP2 and SSP3 (Fricko et al., 2017 [17])

	SSP1	SSP2	SSP3
Residential & Commercial	High electrification rate: 1.44% (Regional range from 0.35% to 4%)	Medium electrification rate: 1.07% (Regional range from 0.23% to 3%)	Low electrification rate: 0.87% (Regional range from 0.37% to 2%)

3.3.3 Industrial sector

Similar to the residential and commercial sectors, the industrial sector in MESSAGEix distinguishes two demand categories, thermal and specific. Thermal demand, i.e., heat at different temperature levels, can be supplied by a variety of different energy carriers while specific demand requires electricity (or a decentralized technology to convert other energy carriers to electricity).

This stylized industrial thermal energy demand includes fuel switching as the main option, i.e., different final energy forms that provide energy for thermal energy can be chosen from. In addition to the alternative energy carriers that serve as input to these thermal energy supply options, their relative efficiencies also vary. For example, solid fuels such as coal have lower conversion efficiencies than natural gas, direct electric heating or electric heat pumps. To account for the fact that some technologies cannot supply temperature at high temperature levels (e.g., electric heat pumps, district heat), the share of these technologies in the provision of industrial thermal demand is constrained. Additional demand reduction in response to price increases in policy scenarios is included via the fuel switching option (due to the fuel-specific relative efficiencies) as well as via the linkage with the macro-economic model MACRO (see Fig. 3.12 below). The specific industrial demand can be satisfied either by electricity from the grid or with decentralized electricity generation options such as fuel cells and on-site CHP.

While cement production is not explicitly modeled at the process level in MESSAGEix, the amount of cement production is linked to industrial activity (more specifically the industrial thermal demand in MESSAGEix) and the associated CO₂ emissions from the calcination process are accounted for explicitly. In addition, adding carbon capture and storage to mitigate these process-based CO₂ emission is available.

Table 3.18 presents the quantitative translation of the the storyline elements of SSP1, SSP2 and SSP3 in terms of electrification rate for industry and feedstocks. These indicators apply to 2010-2100; Intensity improvements are in FE/GDP annually (Fricko et al., 2017 [[17]]).

Table 3.18: Electrification rate within industry and feedstocks for SSP1, SSP2 and SSP3 (Fricko et al., 2017 [17])

	SSP1	SSP2	SSP3
Industry	High electrification rate: 0.56% (Regional range from 0.2% to 1.2%)	Medium electrification rate: 0.47% (Regional range from 0.07% to 1.08%)	Low electrification rate: 0.12% (Regional range from -0.03% to 0.71%)
Feedstock (non-energy use)	High feedstock reduction rate: -0.33% (Regional range from -0.51 to 0.59%)	Medium feedstock reduction rate: -0.27% (Regional range from -0.45% to 0.64%)	Low feedstock reduction rate: -0.24% (Regional range from -0.38% to 0.51%)

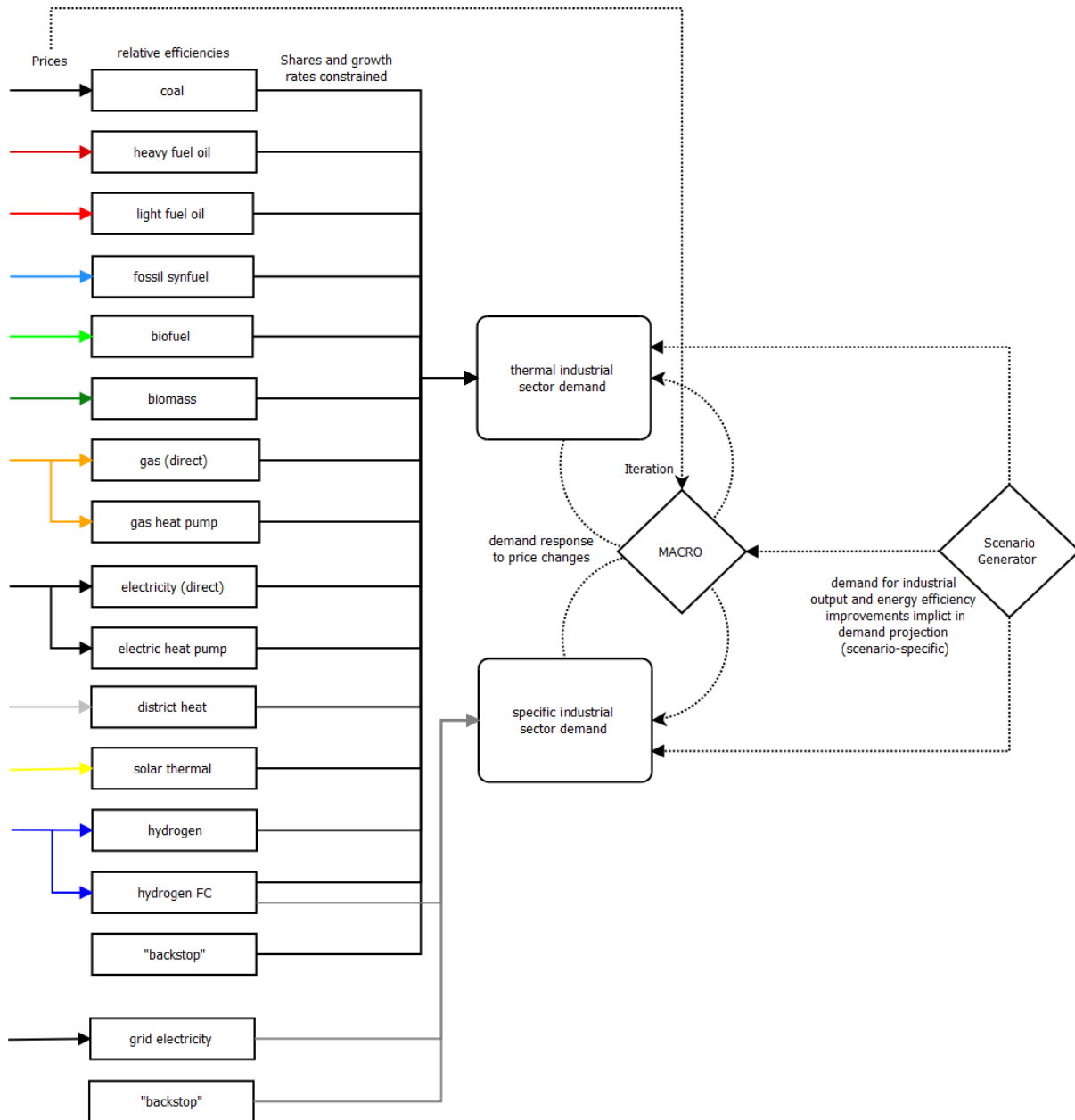

Fig. 3.12: Schematic diagram of the industrial sector representation in MESSAGEix.

3.4 Technological change

Technological change in MESSAGEix is generally treated exogenously, although pioneering works on the endogenization of technological change via learning curves in energy-engineering type models (Messner, 1997 [[60]]) and the dependence of technology costs on market structure have been done with MESSAGEix (Leibowicz, 2015 [[49]]). The current cost and performance parameters, including conversion efficiencies and emission coefficients are generally derived from the relevant engineering literature. For the future, alternative cost and performance projections are developed to cover a relatively wide range of uncertainties that influence model results to a good extent.

3.4.1 Technology cost

The quantitative assumptions about technology cost development are derived from the overarching qualitative SSP narratives (cf. section *SSP narratives*). In SSP1, for instance, whose “green-growth” storyline is more consistent with a sustainable development paradigm, higher rates of technological progress and learning are assumed for renewable energy technologies and other advanced technologies that may replace fossil fuels (e.g., the potential for electric mobility is assumed to be higher in SSP1 compared to SSP2 or SSP3). In contrast, SSP3 assumes limited progress across a host of advanced technologies, particularly for renewables and hydrogen; more optimistic assumptions are instead made for coal-based technologies, not only for power generation but also for liquid fuels production (e.g., coal-to-liquids). Meanwhile, the middle-of-the-road SSP2 narrative is characterized by a fairly balanced view of progress for both conventional fossil and non-fossil technologies. In this sense, technological development in SSP2 is not biased toward any particular technology group.

Technological costs vary regionally in all SSPs, reflecting marked differences in engineering and construction costs across countries observed in the real world. The regional differentiation of technology costs for the initial modeling periods are based on IEA data (IEA, 2014 [[32]]) with convergence of costs assumed over time driven by economic development (GDP/cap). Generally, costs start out lower in the developing world and are assumed to converge to those of present-day industrialized countries as the former becomes richer throughout the century (thus, the cost projections consider both labour and capital components). This catch-up in costs is assumed to be fastest in SSP1 and slowest in SSP3 (where differences remain, even in 2100); SSP2 is in between. Estimates for present-day and fully learned-out technology costs are from the Global Energy Assessment (Riahi et al., 2012 [[80]]) and World Energy Outlook (IEA, 2014 [[2]]). A summary of these cost assumptions can be found in sections *Electricity* and *Other conversion*.

3.4.2 Technology diffusion

MESSAGE tracks investments by vintage, an important feature to represent the inertia in the energy system due to its long-lived capital stock. In case of shocks (e.g., introduction of stringent climate policy), it is however possible to prematurely retire existing capital stock such as power plants or other energy conversion technologies and switch to more suitable alternatives.

An important factor in this context that influences technology adoption in MESSAGEix are technology diffusion constraints. Technology diffusion in MESSAGEix is determined by dynamic constraints that relate the construction of a technology added or the activity (level of production) of a technology in a period t to construction or the activity in the previous period $t-1$ (Messner and Strubegger, 1995 [[62]], cf. section *Dynamic constraints*).

While limiting the possibility of flip-flop behavior as is frequently observed in unconstrained Linear Programming (LP) models such as MESSAGEix, a drawback of such hard growth constraints is that the relative advantage of some technology over another technology is not taken into account and therefore even for very competitive technologies, no rapid acceleration of technology diffusion is possible. In response to this limitation, so called flexible or soft dynamic constraints have been introduced into MESSAGE (Keppo and Strubegger, 2010 [[41]]). These allow faster technology diffusion at additional costs and therefore generate additional model flexibility while still reducing the flip-flop behavior and sudden penetration of technologies.

Fig. 3.13 below illustrates the maximum technology growth starting at a level of 1 in year $t=0$ for a set of five diffusion constraints which jointly lead to a soft constraint.

For a more detailed description of the implementation of technology diffusion constraints, see the Section *Dynamic constraints* of the `MESSAGEix` documentation.

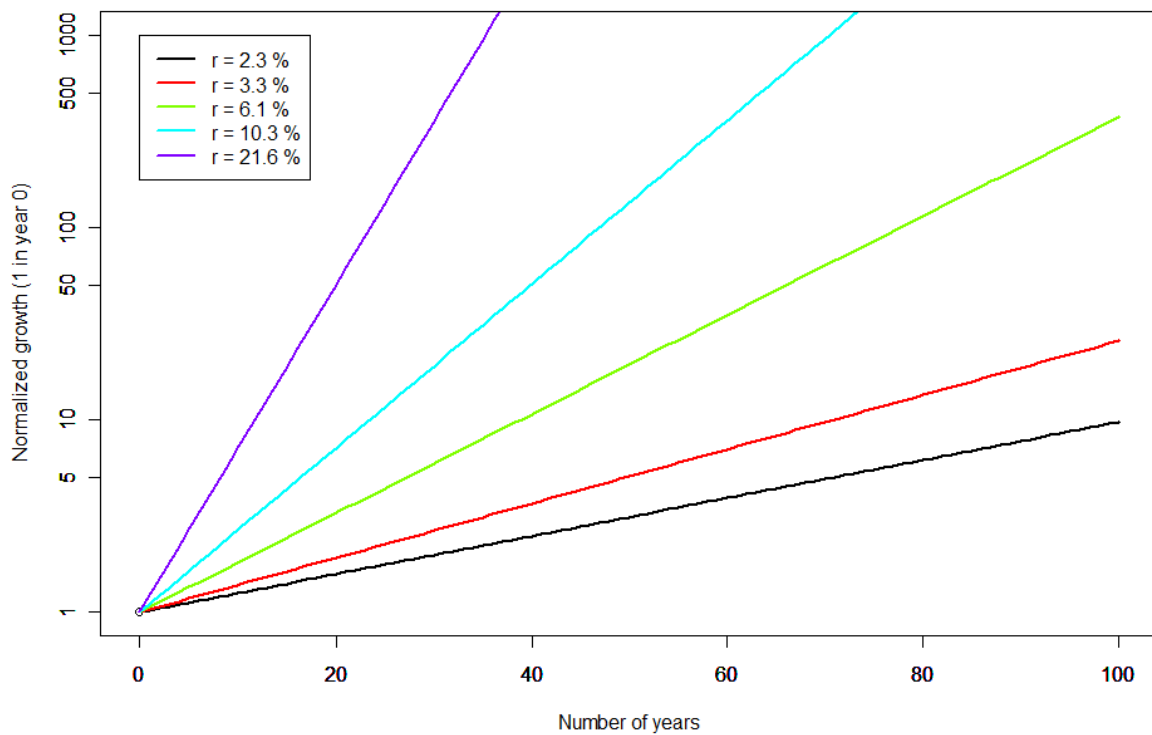

Fig. 3.13: Illustration of maximum technology growth starting at a level of 1 in year $t=0$ for a set of soft diffusion constraints with effective growth rates r as shown in the legend.

3.5 Fuel Blending

Fuel blending in the energy system is a common practice, which allows the shared use of infrastructure by fuels with similar chemical attributes and thus use at the secondary and final energy level, without requiring the consumer to adapt the power plant or end-use devices. Fuel blending in the global energy model is modelled for two distinct blending processes. The first relates to the blending of natural gas with other synthetic gases. The second is related to the blending of light oil with coal derived synthetic liquids. In order to ensure that emissions and energy flows are correctly accounted for, blended fuels types are nevertheless explicitly modelled.

3.5.1 Natural gas and synthetic gas

Natural gas can be blended with hydrogen or with synthetic gas derived from the gasification of biomass or coal (cf. Section *Other conversion*). Despite the fact that in the real world, hydrogen or other synthetic gases are physically injected into a natural gas network, it is important to be able to track the use of blended fuels in the energy model for two reasons. Not all blended fuels can be used equally within all natural gas applications. For example, hydrogen mixed into the natural gas network is restricted to use in non-CCS applications only. Secondly, it is essential to keep track of where which of the blended fuels is being used in order to correctly report emissions and also to potentially restrict the degree to which fuels can be blended for individual applications. For example, natural gas end-use appliances may only be able to cope with a certain share of hydrogen while still guaranteeing their safety and longevity. Similarly, for policy analysis, it could be required that a certain minimum share of a synthetic gas is used sector specifically.

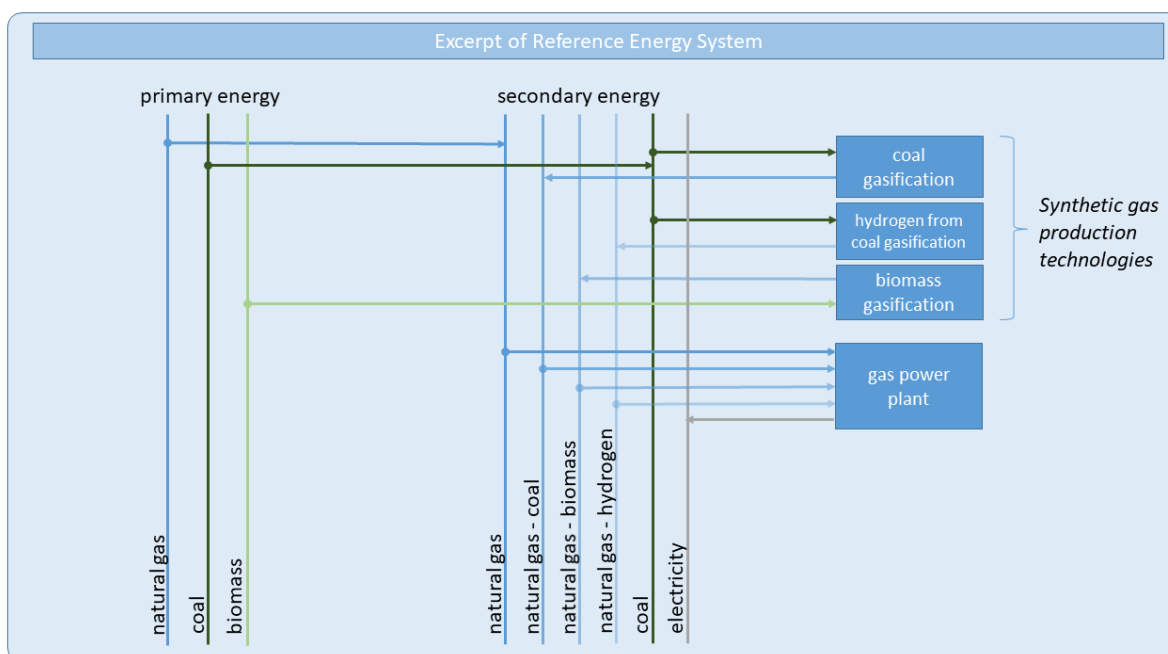

Fig. 3.14: Reference Energy System excerpt depicting the modelling of fuel blending.

3.5.2 Synthetic liquids and lightoil

Synthetic fueloil via coal liquefaction is blended into the lightoil stream at the secondary energy level.

3.6 Add-on technologies

Add-on technologies in the global model refer to a distinct formulation in MESSAGEix. The formulation is used to represent two main types of technical extensions/options for technologies. Add-on technologies provide additional modes of operation for a single or multiple technologies. They can also be used to depict emission mitigation options.

3.6.1 General description of add-on technologies

Add-on technologies can be defined using all the same parameters as any other technology. What makes a technology an *add-on technology*, is the fact that their activity is bound to the activity of one or more other technologies, henceforth referred to as the parent technology. The mathematical formulation can be found [here](#). One of the main benefits of the add-on technology formulation, over specifying an alternative *mode*, is that it allows a single add-on technology to be coupled to the activity of multiple parent technologies. Furthermore, multiple add-on technologies can be linked to the activity of a single parent technology.

3.6.2 Modelling Combined Heat Powerplants (CHPs)

In the global model, there are numerous electricity generation technologies (cf. Section [Electricity](#)). A separate technology, known as a *pass out turbine*, is represented in the model to provide select electricity generation technologies the option to reduce their electricity output in favor of generating electricity and heat. The pass out turbine, which is a steam turbine in which a certain amount of the pressurized steam is passed out of the turbine for the purpose of heat production, is restricted to a share of the activity of the selected electricity generation technologies. Technically, this means that the electricity output of the electricity generation technologies remains unaltered, yet each unit of heat generated by the pass out turbine, requires a certain electricity input. The figure below is an excerpt of the Reference Energy System (RES), showing how the pass-out turbine is modelled.

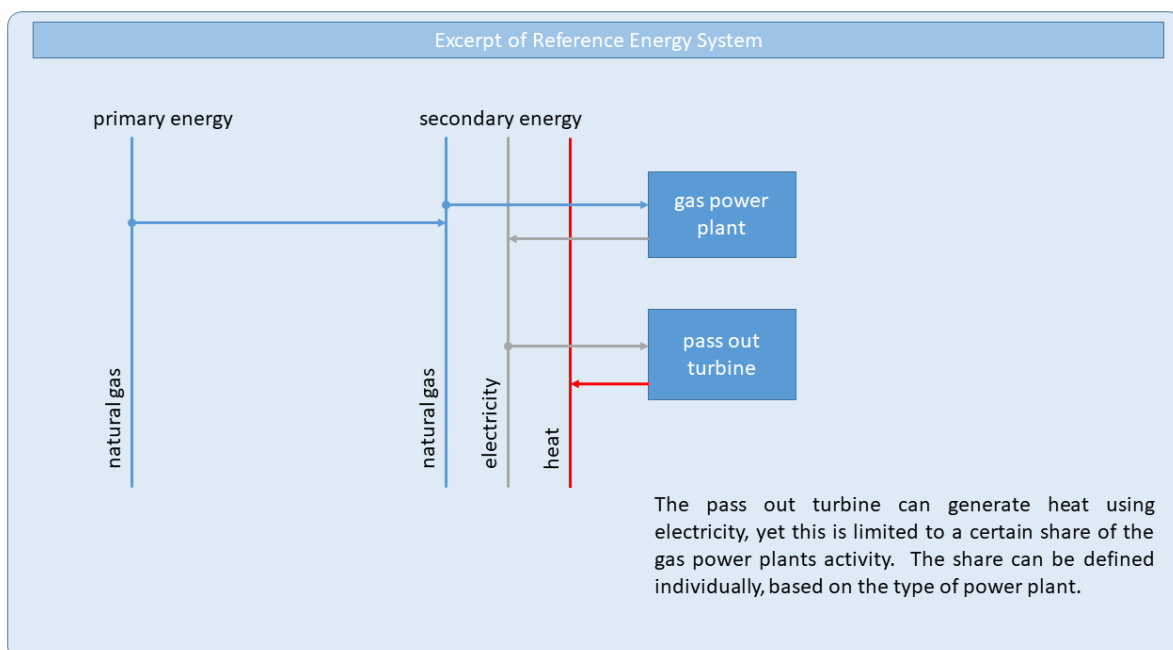

Fig. 3.15: Reference Energy System excerpt depicting the modelling of CHPs.

3.6.3 Modelling emission mitigation options using add-on technologies

CO₂ emission mitigation options for electricity and synthetic fuel generation can be modelled either as green-field power plants with carbon, capture and storage capabilities (CCS), but there is also the possibility to retrofit existing fossil fuel based energy generation technologies with CCS units. The latter, which is less efficient than the greenfield option, but an effective transition option to minimize stranded assets in deep mitigation scenarios, is modelled using the add-on technology formulation. Analogue to the way in which CHPs are modelled, a separate CCS-retrofit unit is depicted in the model, which is constrained by the activity of the respective parent technologies. The CCS-retrofit option requires electricity as an input, therefore mimicking the efficiency reduction associated with the operation of the CCS-retrofit unit. Per unit of activity of the CCS-retrofit, CO₂ emissions are reduced, which differ depending on the assumed capture rates. CCS-retrofits are available for: coal power plants including internal gasification combined cycle plants (IGCC), select gas power plants, biomass power plants, gas and coal fuel cells as well as for hydrogen and cement production.

In the global model, emission mitigation options are modelled using add-on technologies for several other emission sources. N₂O emissions from nitric and adipic acid are driven by industrial GDP and CH₄ landfill emissions are driven by population (Rao and Riahi, 2006 [[77]]). As both GDP and population are model inputs, the developments for these specific sources are therefore not endogenous to the model. Similarly, HFC and SF₆ emissions are linked to specific useful energy demands, which are again a model input, and electricity transmission, respectively. In order to provide mitigation options for these emissions sources, depending on the source, one or several mitigation options are modelled. For each source, the combined activity and therefore the mitigation is coupled to the activity of the parent technology. The share of the total emissions which can be reduced is limited to the technical feasibility and the combination of which mitigation technologies are employed are economically driven.

3.7 Energy demand

Baseline energy service demands are provided exogenously to MESSAGEix, though they can be adjusted endogenously based on energy prices using the MESSAGEix-MACRO link. There are seven energy service demands that are provided to MESSAGEix, including:

1. Residential/commercial thermal
2. Residential/commercial specific
3. Industrial thermal
4. Industrial specific
5. Industrial feedstock (non-energy)
6. Transportation
7. Non-commercial biomass.

These demands are generated using a so-called scenario generator which is implemented in the script language R. The scenario generator relates historical country-level GDP per capita (PPP) to final energy and, using projections of GDP (PPP) and population, extrapolate the seven energy service demands into the future. The sources for the historical and projected datasets are the following:

1. Historical GDP (PPP) – World Bank (World Development Indicators, 2012 [[113]])
2. Historical Population – UN Population Division (World Population Projection, 2010 [[10]])
3. Historical Final Energy – International Energy Agency Energy Balances (IEA, 2012 [[1]])
4. Projected GDP (PPP) – Dellink et al. (2015) [[9]], also see Shared Socio-Economic Pathways database (SSP scenarios)
5. Projected Population – KC and Lutz (2014) [[40]], also see Shared Socio-Economic Pathways database (SSP scenarios)

The scenario generator runs regressions on the historical datasets to establish the relationship for each of the eleven MESSAGEix regions between the independent variable (GDP (PPP) per capita) and the following dependent variables:

1. Total final energy intensity (MJ/2005USD)
2. Shares of final energy among several energy end-use sectors (transport, residential/commercial and industry)
3. Shares of electricity use between the industrial and residential/commercial sectors.

In the case of final energy intensity, the relationship is best modeled by a power function so both variables are log-transformed. In the case of most sectoral shares, only the independent variable is log-transformed. The exception is the industrial share of final energy, which uses a hump-shaped function inspired by Schafer (2005) [[94]].

In parallel, the same historical data are used, now globally, in [quantile regressions](#) to develop global trend lines that represent each percentile of the cumulative distribution function (CDF) of each dependent variable. Given the regional regressions and global trend lines, final energy intensity and sectoral shares can be extrapolated based on projected GDP per capita, or average income.

A basic assumption here is that the regional trends derived above will converge to certain quantiles of the global trend when each region reaches a certain income level. Hence, two key user-defined inputs allow users to tailor the extrapolations to individual socio-economic scenarios: convergence quantile and the corresponding income. In the case of final energy intensity (FEI), the extrapolation is produced for each region by defining the quantile at which FEI converges (e.g., the 20th percentile within the global trend) and the income at which the convergence occurs. For example, while final energy intensity converges quickly to the lowest quantile (0.001) in SSP1, it converges more slowly to a larger quantile (0.5 to 0.7 depending on the region) in SSP3. Convergence quantiles and incomes are provided for each SSP and region in [Table 3.19](#), [Table 3.20](#), [Table 3.21](#). The convergence quantile allows one to identify the magnitude of FEI while the convergence income establishes the rate at which the quantile is approached. For the sectoral shares, users can specify the global quantile at which the extrapolation should converge, the income at which the extrapolation diverges from the regional regression line and turns parallel to the specified convergence quantile (i.e., how long the sectoral share follows the historical trajectory), and the income at which the extrapolation converges to the quantile. Given these input parameters, users can extrapolate both FEI and sectoral shares.

The total final energy in each region is then calculated by multiplying the extrapolated final energy intensity by the projected GDP (PPP) in each time period. Next, the extrapolated shares are multiplied by the total final energy to identify final energy demand for each of the seven energy service demands used in MESSAGE. Finally, final energy is converted to useful energy in each region by using the average final-to-useful energy efficiencies used in the MESSAGE model for each model region (*Regions*).

Table 3.19: Convergence quantile and income for each quantity and region for SSP1 (for region descriptions, see: Regions)

SSP1	AFR	CPA	EEU	FSU	LAM	MEA	NAM	PAO	PAS	SAS	WEU
<i>Convergence Quantile</i>											
Final Energy Intensity (FEI)	0.001	0.001	0.001	0.001	0.001	0.001	0.001	0.001	0.001	0.001	0.001
Share NC Biomass	0.01	0.25	0.01	0.75	0.01	0.3	0.01	0.01	0.01	0.01	0.01
Share Transport	0.05	0.02	0.2	0.05	0.2	0.05	0.2	0.2	0.04	0.03	0.2
Share Res/Com	0.25	0.25	0.2	0.2	0.28	0.3	0.25	0.2	0.28	0.3	0.2
Share Industry	0.1	0.2	0.1	0.5	0.28	0.2	0.3	0.3	0.28	0.2	0.3
Elec Share Res/Com	0.45	0.45	0.45	0.45	0.63	0.62	0.4	0.63	0.62	0.64	0.43
Feedstock Share Industry	0.18	0.2	0.24	0.24	0.2	0.26	0.26	0.23	0.26	0.22	0.24
Elec Share Industry	0.4	0.4	0.42	0.36	0.4	0.33	0.36	0.36	0.4	0.4	0.4
<i>Convergence Income</i>											
Final Energy Intensity (FEI)	112295	98603	299177	112307	100188	113404	112356	112261	106323	112300	107636
Share NC Biomass	5981	46015	34405	40951	20038	34894	112356	112261	16357	11105	48153
Share Transport	99676	32868	112341	71664	112310	113404	123018	94337	112293	97169	141627
Share Res/Com	119611	112276	179506	153565	112310	112270	123018	157229	112293	112300	141627
Share Industry	39870	105177	164547	92139	40075	112270	123018	112261	126769	83288	127464
Elec Share Res/Com	112295	112276	112341	112307	112310	87234	131219	132072	112293	112300	112168
Feedstock Share Industry	112295	112276	112341	112307	112310	112270	123018	125783	112293	112300	112168
Elec Share Industry	112295	98603	299177	112307	100188	113404	112356	112261	106323	112300	107636

Table 3.20: Convergence quantile and income for each quantity and region for SSP2 (for region descriptions, see: Regions)

SSP2	AFR	CPA	EEU	FSU	LAM	MEA	NAM	PAO	PAS	SAS	WEU
<i>Convergence Quantile</i>											
Final Energy Intensity (FEI)	0.03	0.03	0.03	0.04	0.04	0.04	0.05	0.02	0.03	0.03	0.02
Share NC Biomass	0.6	0.6	0.75	0.75	0.25	0.75	0.75	0.75	0.6	0.6	0.75
Share Transport	0.05	0.04	0.15	0.1	0.5	0.3	0.5	0.14	0.2	0.05	0.15
Share Res/Com	0.15	0.28	0.5	0.5	0.3	0.5	0.3	0.35	0.3	0.28	0.33
Share Industry	0.25	0.4	0.15	0.25	0.15	0.25	0.25	0.25	0.25	0.6	0.25
Elec Share Res/Com	0.42	0.4	0.35	0.22	0.58	0.6	0.14	0.57	0.6	0.51	0.18
Feedstock Share Industry	0.15	0.22	0.26	0.26	0.18	0.27	0.32	0.27	0.3	0.22	0.27
Elec Share Industry	0.39	0.38	0.4	0.45	0.35	0.4	0.4	0.4	0.4	0.43	0.35
<i>Convergence Income</i>											
Final Energy Intensity (FEI)	200009	200033	299177	266179	199975	139574	246036	141506	199968	200002	199977
Share NC Biomass	19935	26294	77786	40951	20038	94649	94724	132072	12268	18046	48153
Share Transport	49838	105177	94540	94596	80150	94649	94724	94652	81787	27763	99139
Share Res/Com	119611	65735	89753	71664	94577	69787	94724	110060	81787	83288	113301
Share Industry	31896	105177	44877	102377	100188	78511	94724	141506	98144	13881	94607
Elec Share Res/Com	69773	94593	94540	102377	94577	87234	123018	141506	94627	55525	113301
Feedstock Share Industry	19935	94593	94540	94596	94577	94649	94724	94652	94627	94615	94607
Elec Share Industry	200009	200033	299177	266179	199975	139574	246036	141506	199968	200002	199977

Table 3.21: Convergence quantile and income for each quantity and region for SSP3 (for region descriptions, see: Regions)

SSP3	AFR	CPA	EEU	FSU	LAM	MEA	NAM	PAO	PAS	SAS	WEU
<i>Convergence Quantile</i>											
Final Energy Intensity (FEI)	0.6	0.55	0.5	0.7	0.7	0.5	0.7	0.5	0.5	0.7	0.6
Share NC Biomass	0.9	0.6	0.75	0.75	0.25	0.75	0.75	0.75	0.6	0.9	0.75
Share Transport	0.1	0.05	0.7	0.2	0.45	0.5	0.7	0.25	0.5	0.1	0.7
Share Res/Com	0.25	0.25	0.55	0.55	0.3	0.5	0.35	0.6	0.25	0.2	0.5
Share Industry	0.1	0.6	0.2	0.1	0.2	0.2	0.1	0.1	0.6	0.2	0.1
Elec Share Res/Com	0.4	0.6	0.45	0.4	0.9	0.9	0.25	0.65	0.9	0.6	0.33
Feedstock Share Industry	0.2	0.22	0.26	0.24	0.2	0.3	0.32	0.29	0.3	0.22	0.27
Elec Share Industry	0.3	0.43	0.37	0.45	0.3	0.4	0.35	0.45	0.4	0.35	0.4
<i>Convergence Income</i>											
Final Energy Intensity (FEI)	200009	200033	200000	200044	199975	200027	200109	199995	199968	200002	199977
Share NC Biomass	13955	26294	80927	40951	12023	80953	80782	132072	12268	12771	48153
Share Transport	13955	46015	59835	51188	70131	69787	80782	132072	32715	55525	81010
Share Res/Com	23922	65735	59835	61426	80952	52340	80782	80816	199968	80512	81010
Share Industry	5981	52588	200000	122852	18034	43617	200109	199995	81787	30539	198277
Elec Share Res/Com	80976	80986	80927	61426	80952	69787	80782	80816	80969	80956	81010
Feedstock Share Industry	19935	26294	80927	80980	80952	80953	80782	80816	80969	80956	81010
Elec Share Industry	200009	200033	200000	200044	199975	200027	200109	199995	199968	200002	199977

3.8 Modeling policies

The global energy model distinguishes between eleven global regions (cf. Section *Regions*). It is nevertheless important to represent current and planned national policies - such as the nationally determined contributions (NDCs) as agreed upon in the Paris Agreement - at a lower geographical resolution, in order to be able to adequately account for future changes in the scenario development processes.

3.8.1 Representation of single country Nationally Determined Contributions (NDCs)

The targets formulated in the NDCs come in many different flavors. This applies to the sectors and gases covered by these policies, but it also applies to how these are expressed and quantified. In the global energy model, four broad categories of policy types related to the NDCs are represented, each of which is translated into a set of constraints.

1. Emission targets
2. Energy shares
3. Capacity or generation targets
4. Macro-economic targets

A detailed description of the methodological implementation of the NDCs in the global energy model, along with an extensive list of the energy-related targets considered can be found in Rogelj et al. (2017) [[86]]. Additional policies implemented in the model can also be found in Roelfsema et al. (2020) [[85]].

3.8.2 Emission targets

Country-specific emission reduction targets are specified either in relation to historical emissions (e.g. x% reduction compared to 1990) or in relation to a reference emission trajectory (in the form of a baseline or business as usual scenario (BAU); e.g. x% reduction compared to 2030 emission levels in the baseline). The targets themselves are expressed as either (1) absolute reduction, (2) a percentage reduction or (3) intensity reductions e.g. emissions per GDP or per capita. In order to account for these different reduction targets in the global energy model, the targets are translated so that a regionally specific upper bound on emissions can be formulated. If not further specified, emission constraints are assumed to apply to all sectors and all gases, i.e. total GHGs.

3.8.3 Energy shares

Energy share targets refer to any target which aims to provide a specific energy level (e.g. primary, secondary or final energy) through a specific sub-set of energy forms. The five different forms in which these are formulated in the NDCs are: (1) renewable energy as share of total primary energy, (2) non-fossil energy forms as share of total primary energy, (3) renewable energy as a share of total electricity generation, (4) non-fossil energy as a share of total electricity generation, (5) renewable energy as a form of final energy. All of these share constraint variants can be implemented in the model using the following [mathematical formulation](#). In order to be able to implement these for aggregate regions, it is necessary to harmonize these to single type of share constraint, so that their effects are considered cumulatively within a region. All variants are therefore harmonized to either the share type specified by the largest country, in terms of share of energy within a region, or the most frequently specified type within a region. Separately biofuel shares are implemented specifically for the transport sector.

3.8.4 Capacity and generation targets

Some NDCs specify capacity installation targets, e.g. for planned power plants which will be operational by a certain year. Others specify that a given energy commodity will come from a specific source, for example a certain amount of electricity will stem from a specific intermittent renewable source or nuclear. These targets types are implemented in the model as lower bounds on generation.

3.8.5 Macro-economic targets

3.8.6 Representation of taxes and subsidies

Another set of policies addressed as part of climate change analysis, are energy-related taxes and subsidies. Removing fossil fuel subsidies could help reduce emissions by discouraging the use of inefficient energy forms. In the global energy model, fossil fuel prices are endogenously derived based on underlying supply curves representing the technical costs associated with the extraction of the resources (cf. Section *Fossil Fuel Reserves and Resources*). Refining and processing as well as transmission and distribution costs will be added to the total fuel cost. In order to account for taxes, price adjustment factors are applied, based on the underlying data set as described in Jewell et al. (2018) [[36]].

MACRO-ECONOMY (MACRO)

The detailed energy supply model (MESSAGE) is soft-linked to an aggregated, single-sector macro-economic model (MACRO) which has been derived from the so-called Global 2100 or ETA-MACRO model (Manne and Richels, 1992 [[51]]), a predecessor of the MERGE model. The reason for linking the two models is to consistently reflect the influence of energy supply costs, as calculated by MESSAGE, the mix of production factors considered in MACRO, and the effect of changes in energy prices on energy service demands. The combined MESSAGE-MACRO model (Messner and Schrattenholzer, 2000 [[61]]) can generate a consistent economic response to changes in energy prices and estimate overall economic consequences (e.g., changes in GDP or household consumption) of energy or climate policies.

MACRO is a macroeconomic model maximizing the intertemporal utility function of a single representative producer-consumer in each world region. The optimization result is a sequence of optimal savings, investment, and consumption decisions. The main variables of the model are capital stock, available labor, and energy inputs, which together determine the total output of an economy according to a nested CES (constant elasticity of substitution) production function. End-use service demands in the (commercial) demand categories of MESSAGE (see *Energy demand*) is determined within the MACRO model, and is consistent with energy supply from MESSAGE, which is an input to the MACRO. The model's most important driving input variables are the projected growth rates of total labor, i.e., the combined effect of labor force and labor productivity growth, and the annual rates of reference energy intensity reduction, i.e. the so-called autonomous energy efficiency improvement (AEEI) coefficients. The latter are calibrated to the developments in a MESSAGE baseline scenario to ensure consistency between the two models. Labor supply growth is also referred to as reference or potential GDP growth. In the absence of price changes, energy demands grow at rates that are the approximate result of potential GDP growth rates, reduced by the rates of overall energy intensity reduction. Price changes of the six demand categories, for example induced by energy or climate policies, can alter this path significantly.

MACRO's production function includes six commercial energy demand categories represented in MESSAGE. To optimize, MACRO requires cost information for each demand category. The exact definitions of these costs as a function over all positive quantities of energy cannot be given in closed form because each point of the function would be a result of a full MESSAGE run. However, the optimality conditions implicit in the formulation of MACRO only require the functional values and its derivatives at the optimal point to be consistent between the two models. Since these requirements are therefore only local, most functions with this feature will simulate the combined energy-economic system in the neighborhood of the optimal point. The regional costs (of energy use and imports) and revenues (from energy exports) of providing energy in MACRO are approximated by a Taylor expansion to first order of the energy system costs as calculated by MESSAGE. From an initial MESSAGE model run, the total energy system cost (including costs/revenues from energy trade) and additional abatement costs (e.g., abatement costs from non-energy sources) as well as the shadow prices of the six commercial demand categories by region are passed to MACRO. In addition to the economic implications of energy trade, the data exchange from MESSAGE to MACRO may also include the revenues or costs of trade in GHG permits.

Consult the [MACRO](#) section of the [MESSAGEix](#) documentation for a description of the MACRO system of equations, its implementation in `message_ix`, parameterization, and calibration procedure.

LAND-USE (GLOBIOM)

Land-use dynamics are modelled with the GLOBIOM (GLobal BIOSphere Management) model, which is a partial-equilibrium model (Havlik et al., 2011 [[25]]; Havlik et al., 2014 [[26]]). GLOBIOM represents the competition between different land-use based activities. It includes a detailed representation of the agricultural, forestry and bio-energy sector, which allows for the inclusion of detailed grid-cell information on biophysical constraints and technological costs, as well as a rich set of environmental parameters, incl. comprehensive AFOLU (agriculture, forestry and other land use) GHG emission accounts and irrigation water use. For spatially explicit projections of the change in afforestation, deforestation, forest management, and their related CO₂ emissions, GLOBIOM is coupled with the G4M (Global FORest Model) model (Kindermann et al., 2006 [[45]]; Kindermann et al., 2008 [[43]]; Gusti, 2010 [[22]]). The spatially explicit G4M model compares the income of forest (difference of wood price and harvesting costs, income by storing carbon in forests) with income by alternative land use on the same place, and decides on afforestation, deforestation or alternative management options. As outputs, G4M provides estimates of forest area change, carbon uptake and release by forests, and supply of biomass for bioenergy and timber.

As a partial equilibrium model representing land-use based activities, including agriculture, forestry and bioenergy sectors (see Fig. 5.1), production adjusts to meet the demand at the level of 30 economic regions (see list of the regions in Section *Regions*). International trade representation is based on the spatial equilibrium modelling approach, where individual regions trade with each other based purely on cost competitiveness because goods are assumed to be homogenous (Takayama and Judge, 1971 [[104]]; Schneider, McCarl et al., 2007 [[97]]). Market equilibrium is determined through mathematical optimization which allocates land and other resources to maximize the sum of consumer and producer surplus (McCarl and Spreen, 1980 [[52]]). As in other partial equilibrium models, prices are endogenous. The model is run recursively dynamic with a 10 year time step, going from 2000 to 2100. The model is solved using a linear programming solver and can be run on a personal computer with the GAMS software.

5.1 Spatial resolution

Land resources and their characteristics are the fundamental elements of the GLOBIOM modelling approach. In order to enable global bio-physical process modelling of agricultural and forest production, a comprehensive database has been built (Skalsky et al., 2008 [[100]]), which contains geo-spatial data on soil, climate/weather, topography, land cover/use, and crop management (e.g. fertilization, irrigation). The data were compiled from various sources (FAO, ISRIC, USGS, NASA, CRU UEA, JRC, IFRPI, IFA, WISE, etc.) and significantly vary with respect to spatial, temporal, and attribute resolutions, thematic relevance, accuracy, and reliability. Therefore, data were harmonized into several common spatial resolution layers including 5 and 30 Arcmin as well as country layers. Subsequently, Homogeneous Response Units (HRU) have been delineated by geographically clustering according to only those parameters of the landscape, which are generally not changing over time and are thus invariant with respect to land use and management or climate change. At the global scale, five altitude classes, seven slope classes, and five soil classes have been included.

In a second step, the HRU layer is intersected with a 0.5 x 0.5 degree grid and country boundaries to delineate Simulation Units (SimUs) which contain other relevant information such as global climate data, land category/use data, irrigation data, etc. In total, 212,707 SimUs are delineated by clustering 5 x 5 minutes of arc pixels according to five criteria: altitude, slope, and soil class, 0.5 x 0.5 degrees grid, and the country boundaries. The SimUs are the basis for estimation of land use/management parameters in all other supporting models as well. For each SimU a number of land management options are simulated using the bio-physical process model EPIC (Environmental Policy Integrated Climate) (Izaurrealde et al., 2006 [[35]]; Williams and Singh, 1995 [[107]]). For the SSP application of

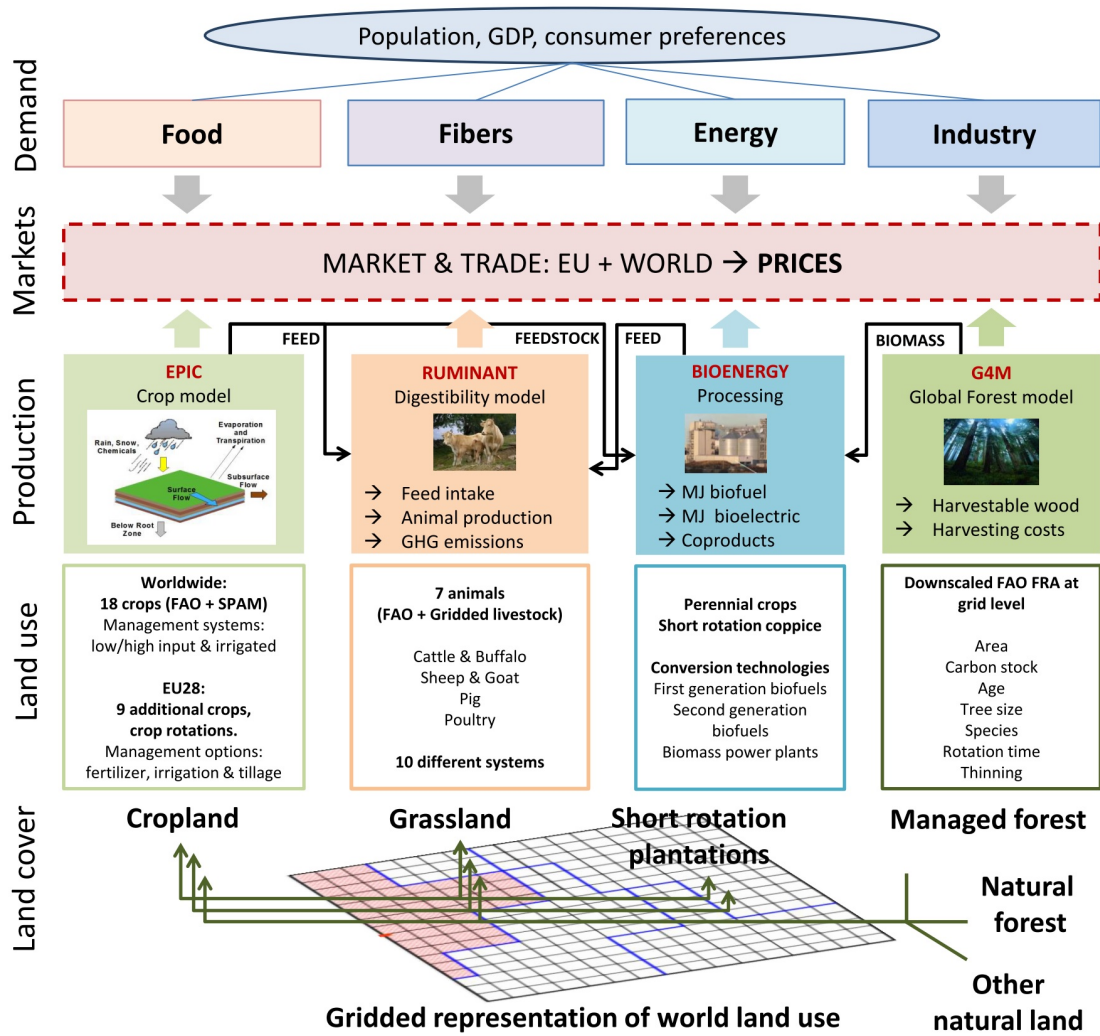

Fig. 5.1: GLOBIOM land use and product structure.

GLOBIOM, in order to ease computation time, the input data sets and the model resolution were aggregated to 2 x 2 degree cells disaggregated only by country boundaries and by three agro-ecological zones used in the livestock production system classification: arid, humid, temperate and tropical highlands. This led to a total of 10,894 different Supply Units.

5.2 Crop production

GLOBIOM directly represents production from three major land cover types: cropland, managed forest, and areas suitable for short rotation tree plantations. Crop production accounts for more than 30 of the globally most important crops. The average yield level for each crop in each country is taken from FAOSTAT. Management related yield coefficients according to fertilizer and irrigation rates are explicitly simulated with the EPIC model (Williams and Singh, 1995 [[107]]) for 17 crops (barley, dry beans, cassava, chickpea, corn, cotton, ground nuts, millet, potatoes, rapeseed, rice, soybeans, sorghum, sugarcane, sunflower, sweet potatoes, and wheat). These 17 crops together represent nearly 80 % of the 2007 harvested area and 85% of the vegetal calorie supply as reported by FAOSTAT. Four management systems are considered (irrigated, high input - rainfed, low input - rainfed and subsistence management systems) corresponding to the International Food and Policy Research Institute (IFPRI) crop distribution data classification (You and Wood, 2006 [[109]]). Within each management system, input structure is fixed following a Leontieff production function. But crop yields can change in reaction to external socio-economic drivers through switch to another management system or reallocation of the production to a more or less productive Supply Unit.

Besides the endogenous mechanisms, an exogenous component representing long-term technological change is also considered. Only two management systems are differentiated for the remaining crops (bananas, other dry beans, coconuts, coffee, lentils, mustard seed, olives, oil palm, plantains, peas, other pulses, sesame seed, sugar beet, and yams) – rainfed and irrigated. Rainfed and irrigated crop yield coefficients, and crop specific irrigation water requirements for crops not simulated with EPIC, and costs for four irrigation systems for all crops, are derived from a variety of sources as described in Sauer et al. (2008) [[93]]. Crop supply can enter one of three processing/demand channels: consumption, livestock production and biofuel production (see Fig. 5.1).

5.3 Livestock

5.3.1 Livestock population

The principal variable characterizing the livestock production in GLOBIOM is the number of animals by species, production system and production type in each Simulation Unit. GLOBIOM differentiates four species aggregates: cattle and buffaloes (bovines), sheep and goats (small ruminants), pigs, and poultry. Eight production systems are specified for ruminants: grazing systems in arid (LGA), humid (LGH) and temperate/highland areas (LGT); mixed systems in arid (MXA), humid (MXH) and temperate/highland areas (MXT); urban systems (URB); and other systems (OTH). Mixed systems are an aggregate of the more detailed original Sere and Steinfeld's classes (Sere and Steinfeld, 1996 [[99]]) – mixed rainfed and mixed irrigated. Two production systems are specified for monogastrics: smallholders (SMH) and industrial systems (IND). In terms of production type, dairy and meat herds are modeled separately for ruminants: dairy herd includes adult females and replacement heifers, whose diets are distinguished. Poultry in smallholder systems is considered as mixed producer of meat and eggs, and poultry in industrial systems is split into laying hens and broilers, with differentiated diet regimes. Overall livestock numbers at the country level are, where possible while respecting minimum herd dynamics rules, harmonized with FAOSTAT.

The spatial distribution of ruminants and their allocation between production systems follows an updated version of Wint and Robinson (Wint and Robinson, 2007 [[108]]). Since better information is not available, it is assumed that the share of dairy and meat herds within one region is the same in all production systems. The share is obtained from the FAO country level data about milk producing animals and total herd size. Monogastrics are not treated in a spatially explicit way since no reliable maps are currently available, and because monogastrics are not linked in the model to specific spatial features, like grasslands. The split between smallholder and industrial systems follows Herrero et al. (2013) [[27]].

5.3.2 Livestock products

Each livestock category is characterized by product yield, feed requirements, and a set of direct GHG emission coefficients. On the output side, seven products are defined: bovine meat and milk, small ruminant meat and milk, pig meat, poultry meat, and eggs. For each region, production type and production system, individual productivities are determined.

Bovine and small ruminant productivities are estimated through the RUMINANT model (Herrero et al., 2008 [[28]]; Herrero et al., 2013 [[27]]), in a three steps process which consists of first, specifying a plausible feed ration; second, calculating in RUMINANT the corresponding yield; and finally confronting at the region level with FAOSTAT (Supply Utilization Accounts) data on production. These three steps were repeated in a loop until a match with the statistical data was obtained. Monogastrics productivities were disaggregated from FAOSTAT based on assumptions about potential productivities and the relative differences in productivities between smallholder and industrial systems. The full detail of this procedure is provided in Herrero et al. (2013) [[27]].

Final livestock products are expressed in primary commodity equivalents. Each product is considered as a differentiated good with a specific market except for bovine and small ruminant milk that are merged in a single milk market. The two milk types are therefore treated as perfect substitutes.

5.3.3 Livestock feed

Feed requirements for ruminants are computed simultaneously with the yields (Herrero et al., 2013 [[27]]). Specific diets are defined for the adult dairy females, and for the other animals. The feed requirements are first calculated at the level of four aggregates – grains (concentrates), stover, grass, and other. When estimating the feed-yield couples, the RUMINANT model takes into account different qualities of these aggregates across regions and systems. Feed requirements for monogastrics are at this level determined through literature review presented in Herrero et al. (2013) [[27]]. In general, it is assumed that in industrial systems pigs and poultry consume 10 and 12 kg dry matter of concentrates per TLU and day, respectively, and concentrates are the only feed sources. Smallholder animals get only one quarter of the amount of grains fed in industrial systems, the rest is supposed to come from other sources, like household waste, not explicitly represented in GLOBIOM.

The aggregate GRAINS input group is harmonized with feed quantities as reported at the country level in Commodity Balances of FAOSTAT. The harmonization proceeds in two steps, where first, GRAINS in the feed rations are adjusted so that total feed requirements at the country level match with total feed quantity in Commodity Balances, and second, “Grains” is disaggregated into 11 feed groups: Barley, Corn, Pulses, Rice, Sorghum & Millet, Soybeans, Wheat, Cereal Other, Oilseed Other, Crops Other, Animal Products. The adjustment of total GRAINS quantities is first done through shifts between the GRAINS and OTHER categories in ruminant systems. Hence, if total GRAINS are lower than the statistics, a part or total feed from the OTHER category is moved to GRAINS. If this is not enough, all GRAINS requirements of ruminants are shifted up in the same proportions. If total GRAINS are higher than the statistics, then firstly a part of them must be reallocated to the OTHER category. If this is not enough, values are to be kept, which then results in higher GRAINS demand than reported in FAOSTAT. This inconsistency is overcome in GLOBIOM, by creating a “reserve” of the missing GRAINS. This reserve is in simulations kept constant, thus it enables to reproduce the base year activity levels mostly consistent with FAOSTAT, but requires that all additional GRAINS demand arising over the simulation horizon is satisfied from real production. The decomposition of GRAINS into the 11 subcategories has to follow predefined minima and maxima of the shares of feedstuffs in a ration differentiated by species and region. At the same time, the shares of the feedstuffs corresponding to country level statistics need to be respected. This problem is solved as minimization of the square deviations from the prescribed minimum and maximum limits. In GLOBIOM, the balance between demand and supply of the crop products entering the GRAINS subcategories needs to be satisfied at regional level. Substitution ratios are defined for the byproducts of biofuel industry so that they can also enter the feed supply.

STOVER is supposed less mobile than GRAINS, therefore stover demand in GLOBIOM is forced to match supply at grid level. The demand is mostly far below the stover availability. In the cells where this is not the case, the same system of reserve is implemented as for the grains. No adjustments are done to the feed rations as such.

There are unfortunately no worldwide statistics available on either consumption or production of grass. Hence grass requirements were entirely based on the values calculated with RUMINANT, and were used to estimate the grassland extent and productivity. (This procedure is described in the next section.)

Finally, the feed aggregate OTHER is represented in a simplified way, where it is assumed that it is satisfied entirely from a reserve in the base year, and all additional demand needs to be satisfied by forage production on grasslands.

5.3.4 Grazing forage availability

The demand and supply of grass need to match at the level of Simulation Unit in GLOBIOM. But reliable information about grass forage supply is not available even at the country level. The forage supply is a product of the utilized grassland area and of forage productivity. However, at global scale, Ramankutty et al. (2008) [[73]] estimated that the extent of pastures spans in the 90% confidence interval between 2.36 and 3.00 billion hectares. The FAOSTAT estimate of 3.44 billion hectares itself falls outside of this interval which illustrates the level of uncertainty in the grassland extent. Similarly, with respect to forage productivity, different grassland production models perform better for different forage production systems and all are confronted with considerable uncertainty due to limited information about vegetation types, management practices, etc. (Conant and Paustian, 2004 [[8]]). These limitations precluded reliance on any single source of information or output from a single model. Therefore three different grass productivity sources were considered: CENTURY on native grasslands, CENTURY on native and managed grasslands, and EPIC on managed grasslands.

A systematic process was developed for selecting the suitable productivity source for each of GLOBIOM's 30 regions. This process allowed reliance on sound productivity estimates that are consistent with other GLOBIOM datasets like spatial livestock distribution and feed requirements. Within this selection process, the area of utilized grasslands corresponding to the base year 2000 was determined simultaneously with the suitable forage productivity layer. Two selection criteria were used: livestock requirements for forage and area of permanent meadows and pastures from FAOSTAT. The selection process was based on simultaneous minimization of i) the difference between livestock demand for forage and the model-estimates of forage supply and ii) the difference between the utilized grassland area and FAOSTAT statistics on permanent meadows and pastures. Regional differentiation in grassland management intensity, ranging from dry grasslands with minimal inputs to mesic, planted pastures that are intensively managed with large external inputs – further informed the model selection by enabling constraints in the number of models for dry grasslands.

To calculate the utilized grassland area, the potential grassland area was first defined as the area belonging to one of the following GLC2000 land cover classes: 13 (Herbaceous Cover, closed-open), 16-18 (Cultivated and managed areas, Mosaic: Cropland / Tree Cover / Other natural vegetation, Mosaic: Cropland / Shrub and/or grass cover), excluding area identified as cropland according to the IFPRI crop distribution map (You and Wood, 2006 [[109]]), and 11, 12, 14 (Shrub Cover, closed-open, evergreen, Shrub Cover, closed-open, deciduous, Sparse herbaceous or sparse shrub cover). In each Simulation Unit the utilized area was calculated by dividing total forage requirements by forage productivity. In Simulation Units where utilized area was smaller than the potential grassland area, the difference would be allocated to either “Other Natural Land” or “Other Agricultural Land” depending on the underlying GLC2000 class. In Simulation Units where the grassland area necessary to produce the forage required in the base year was larger than the potential grassland area, a “reserve” was created to ensure base year feasibility, but all the additional grass demand arising through future livestock production increases needed to be satisfied from grasslands.

Forage productivity was estimated using the CENTURY (Parton et al., 1987 [[71]]; Parton et al., 1993 [[70]]) and EPIC (Williams and Singh, 1995 [[107]]) models. The CENTURY model was run globally at 0.5 degree resolution to estimate native forage and browse and planted pastures productivity. It was initiated with 2000 year spin-ups using mean monthly climate from the Climate Research Unit (CRU) of the University of East Anglia with native vegetation for each grid cell, except cells dominated by rock, ice, and water, which were excluded. Information about native vegetation was derived from the Potsdam intermodal comparison study (Schloss et al., 1999 [[95]]). Plant community and land management (grazing) was based on growing-season grazing and 50 per cent forage removal. Areas under native vegetation that were grazed were identified using the map of native biomes subject to grazing and subtracting estimated crop area within those biomes in 2006 (Ramankutty et al., 2008 [[73]]). It is assumed 50 per cent grazing efficiency for grass, and 25 per cent for browse for native grasslands. These CENTURY-based estimates of native grassland forage production (CENTURY_NAT) were used for most regions with low-productivity grasslands (Fig. 5.2).

Both the CENTURY and EPIC models were used to estimate forage production in mesic, more productive regions. For the CENTURY model, forage yield was simulated using a highly-productive, warm-season grass parameterization. Production was modeled in all cells and applied to areas of planted pasture, which were estimated based on biomes that were not native rangelands, but were under pasture in 2006 according to Ramankutty (Ramankutty et al., 2008 [[73]]). Pastures were replanted in the late winter every ten years, with grazing starting in the second year.

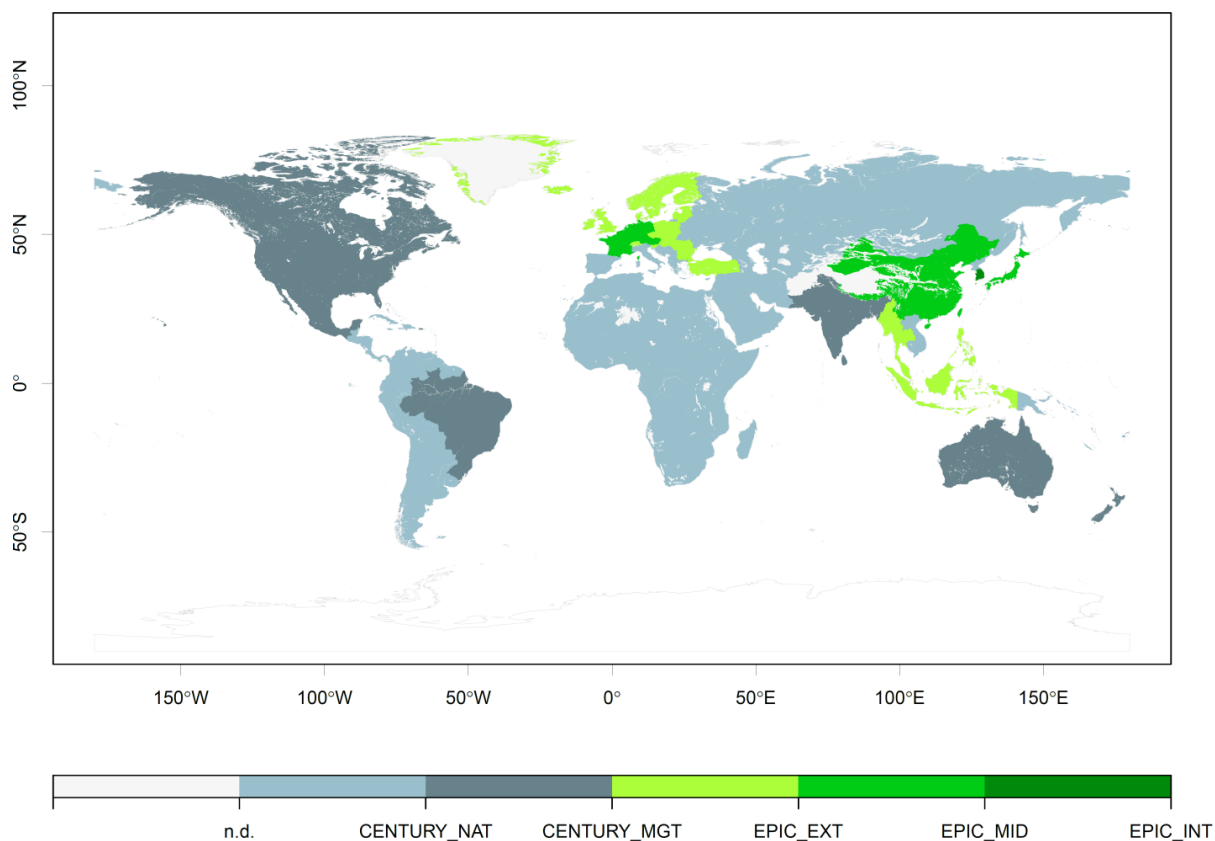

Fig. 5.2: Data sources used to parameterize forage availability in different world regions. CENTURY_NAT – CENTURY model for native grasslands; CENTURY_MGT – CENTURY model for productive grasslands; EPIC_EXT – EPIC model for grasslands under extensive management; EPIC_MID – EPIC model for grasslands under semi-intensive management; EPIC_INT – EPIC model for grasslands under intensive management.

Observed monthly precipitation and minimum and maximum temperatures between 1901 and 2006 were from the CRU Time Series data, CRU TS30 (Mitchell and Jones, 2005 [[63]]) Soils data were derived from the FAO Soil Map of the World, as modified by Reynolds et al. (2000) [[79]]. CENTURY model output for productive pastures (CENTURY_MGT) were the best-match for area/forage demand in much of the world with a mixture of mesic and drier pastures.

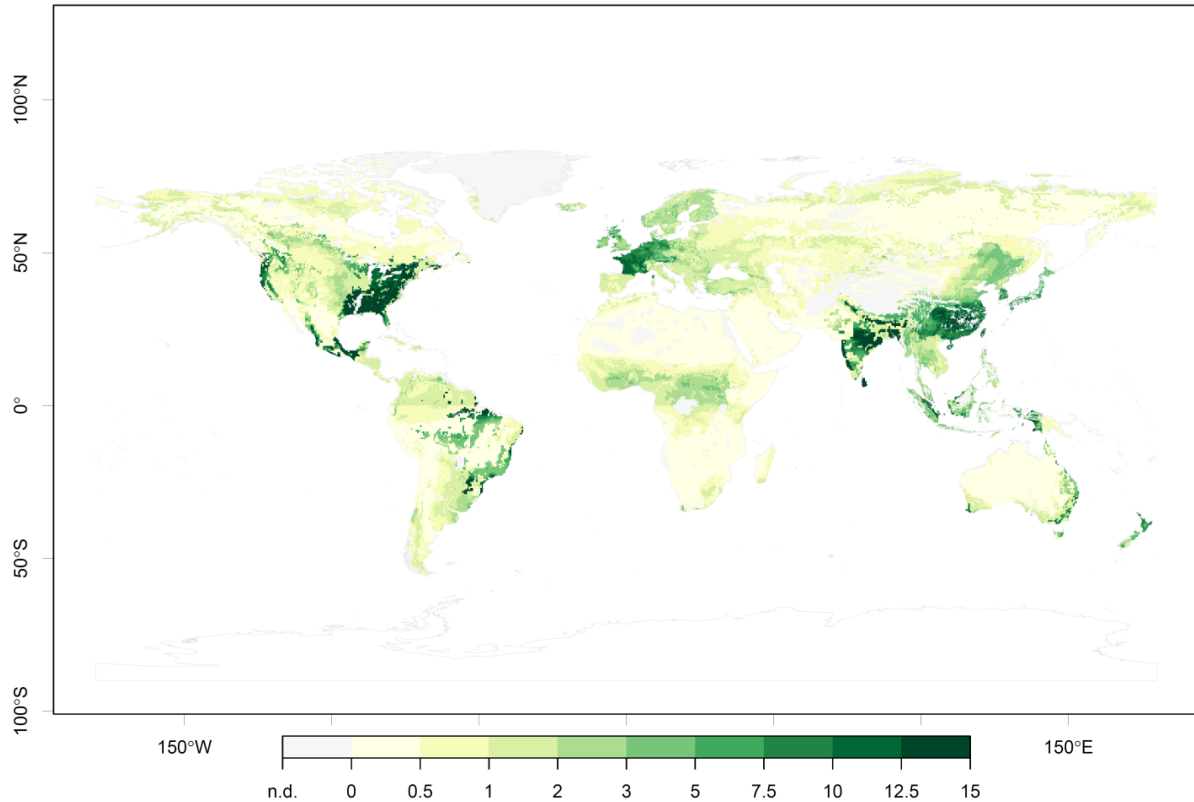

Fig. 5.3: Forage available for livestock in tonnes of dry matter per hectare as the result of combination of outputs from the CENTURY and EPIC models.

The EPIC model was the best fit for much of Europe and Eastern Asia, where most of the forage production is in intensively-managed grasslands. The EPIC simulations used the same soil and climatic drivers as the CENTURY runs plus topography data (high-resolution global Shuttle Radar Topography Mission digital elevation model (SRTM) and the Global 30 Arc Second Elevation Data (GTOPO30)). Warm and cold seasonal grasses were simulated in EPIC, and the simulations included a range of management intensities represented by different levels of nitrogen fertilizer inputs and off-take rates. The most intensive management minimizing nitrogen stress and applying 80% off-take rates (EPIC_INT) was found to be the best match for South Korea. Highly fertilized grasslands but with an off-take rate of 50% only were identified in Western Europe, China and Japan (EPIC_MID), and finally extensive management, only partially satisfying the nitrogen requirements and considering 20% off-take rates corresponded best to Central and Northern Europe and South-East Asia (EPIC_EXT). The resulting hybrid forage availability map is represented in Fig. 5.3.

5.3.5 Livestock dynamics

In general, the number of animals of a given species and production type in a particular production system and Supply Unit is an endogenous variable. This means that it will decrease or increase in relation to changes in demand and the relative profitability with respect to competing activities.

Herd dynamics constraints need however to be respected. First, dairy herds are constituted of adult females and followers, and expansion therefore occurs in predefined proportions in the two groups. Moreover, for regions where the specialized meat herds are insignificant (no suckler cows), expansion of meat animals (surplus heifers and males) is also assumed proportional in size to the dairy herd. The ruminants in urban systems are not allowed to expand because this category is not well known and because it is fairly constrained by available space in growing cities. Finally, the decrease of animals per system and production type higher than 15 per cent per 10 years period are not considered, and no increase by more than 100 per cent on the same period. At the level of individual systems, the decrease can however be as deep as 50 per cent per system on a single period.

For monogastrics, the assumption is made that all additional supply will come from industrial systems and hence the number of animals in other systems is kept constant (Keyzer et al., 2005 [[42]]).

5.4 Forestry

The forestry sector is represented in GLOBIOM with five categories of primary products (pulp logs, saw logs, biomass for energy, traditional fuel wood, and other industrial logs) which are consumed by industrial energy, cooking fuel demand, or processed and sold on the market as final products (wood pulp and sawnwood). These products are supplied from managed forests and short rotation plantations. Harvesting cost and mean annual increments are informed by the G4M global forestry model (Kindermann et al., 2006 [[45]]) which in turn calculates them based on thinning strategies and length of the rotation period.

Primary forest production from traditional managed forests is characterized also at the level of SimUs. The most important parameters for the model are mean annual increment, maximum share of saw logs in the mean annual increment, and harvesting cost. These parameters are shared with the G4M model – a successor of the model described by Kindermann et al. (2006) [[45]]. More specifically, mean annual increment for the current management, is obtained by downscaling biomass stock data from the Global Forest Resources Assessment (FAO, 2006 [[14]]) from the country level to a 0.5 x 0.5 degree grid using the method described in Kindermann et al. (2008) [[44]]. The downscaled biomass stock data is subsequently used to parameterize increment curves. Finally, the saw logs share is estimated by the tree size, which in turn depends on yield and rotation time. Harvesting costs are adjusted for slope and tree size as well. Among the five primary forest products, saw logs, pulp logs and biomass for energy are further processed. Sawn wood and wood pulp production and demand parameters rely on the 4DSM model described in Rametsteiner et al. (2007) [[74]]. FAO data and other secondary sources have been used for quantities and prices of sawn wood and wood pulp. For processing cost estimates of these products an internal IIASA database and proprietary data (e.g. RISI database for locations of individual pulp and paper mills, with additional economic and technical information, <http://www.risiinfo.com>) were used. Biomass for energy can be converted in several processes: combined heat and power production, fermentation for ethanol, heat, power and gas production, and gasification for methanol and heat production. Processing cost and conversion coefficients are obtained from various sources (Biomass Technology Group, 2005 [[20]]; Hamelinck and Faaij, 2001 [[23]]; Leduc et al., 2008 [[48]]; Sorensen, 2005 [[101]]). Demand for woody bioenergy production is implemented through minimum quantity constraints, similar to demand for other industrial logs and for firewood. Woody biomass for bioenergy can also be produced on short rotation tree plantations. To parameterize this land use type in terms of yields, an evaluation of the land availability and suitability was carried out. Calculated plantation costs involve the establishment cost and the harvesting cost. The establishment related capital cost includes only sapling cost for manual planting (Carpentieri et al., 1993 [[5]]; Herzogbaum GmbH, 2008 [[29]]). Labour requirements for plantation establishment are based on Jurvelius (1997) [[39]], and consider land preparation, saplings transport, planting and fertilization. These labour requirements are adjusted for temperate and boreal regions to take into account the different site conditions. The average wages for planting are obtained from ILO (2007) [[33]]. Harvesting cost includes logging and timber extraction. The unit cost of harvesting equipment and labour is derived from various datasets for Europe and North America (e.g. FPP, 1999 [[16]]; Jiroušek et al., 2007 [[37]]; Stokes et al., 1986 [[102]]; Wang et al., 2004 [[106]]). Because the productivity of harvesting equipment depends on terrain conditions, a slope factor (Hartsough et al., 2001 [[24]]) was integrated to estimate total harvesting cost. The labour cost, as well as the cost of saplings, is regionally adjusted by the ratio of mean PPP (purchasing power parity over GDP), (Heston et al., 2006 [[30]]).

5.5 Land use change

The model optimizes over six land cover types: cropland, grassland, short rotation plantations, managed forests, unmanaged forests and other natural land. Economic activities are associated with the first four land cover types. There are other three land cover types represented in the model: other agricultural land, wetlands, and not relevant (bare areas, water bodies, snow and ice, and artificial surfaces). These three categories are currently kept constant. Each Simulation Unit can contain the nine land cover types. The base year spatial distribution of land cover is based on the Global Land Cover 2000 (GLC2000). However, as any other global dataset of this type, GLC2000 suffers from large uncertainty (Fritz et al., 2011 [[19]]). Therefore auxiliary datasets and procedures are used to transform this “raw” data into a consistent dataset corresponding to the model needs.

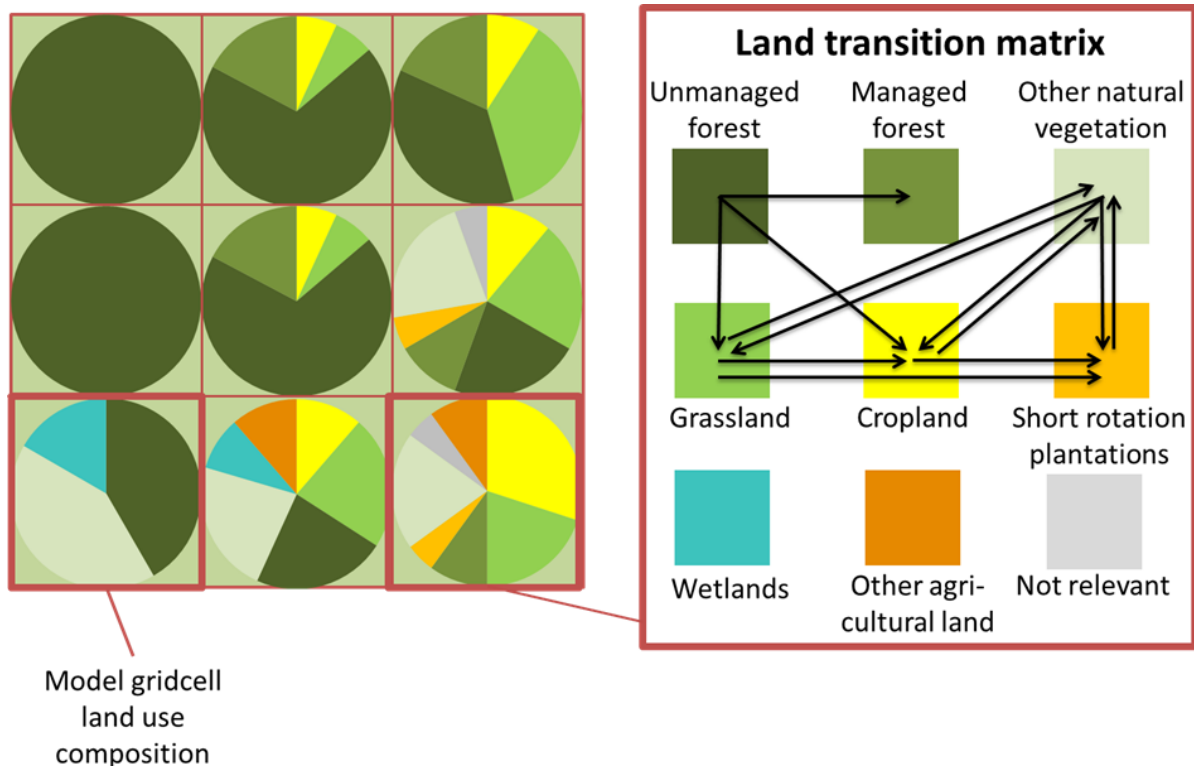

Fig. 5.4: Land cover representation in GLOBIOM and the matrix of endogenous land cover change possibilities (Havlik et al., 2014 [[26]]).

Land conversion over the simulation period is endogenously determined for each Supply Unit within the available land resources. Such conversion implies a conversion cost – increasing with the area of land converted - that is taken into account in the producer optimization behavior. Land conversion possibilities are further restricted through biophysical land suitability and production potentials, and through a matrix of potential land cover transitions (Fig. 5.4).

5.6 Food demand

Food demand is in GLOBIOM endogenous and depends on population, gross domestic product (GDP) and own product price. Population and GDP are exogenous variables while prices are endogenous. The simple demand system is presented in Eq. (5.1). First, for each product i in region r and period t , the prior demand quantity Q is calculated as a function of population POP, GDP per capita GDP^{cap} adjusted by the income elasticity ε^{GDP} , and the base year consumption level as reported in the Food Balance Sheets of FAOSTAT. If the prior demand quantity could be satisfied at the base year price P , this would be also the optimal demand quantity Q . However, usually the optimal quantity will be different from the prior quantity, and will depend on the optimal price P and the price elasticity ε^{price} , the latter calculated from USDA (Seale et al., 2003 [[98]]), updated in Muhammad et al. (2011) [[64]] for

the base year 2000. Because food demand in developed countries is more inelastic than in developing ones, the value of this elasticity is assumed to decrease with the level of GDP per capita. The rule applied is that the price elasticity of developing countries converges to the price elasticity of the USA in 2000 at the same pace as their GDP per capita reach the USA GDP per capita value of 2000. This allows capturing the effect of change in relative prices on food consumption taking into account heterogeneity of responses across regions, products and over time.

$$\frac{Q_{i,r,t}}{\bar{Q}_{i,r,t}} = \left(\frac{P_{i,r,t}}{\bar{P}_{i,r,2000}} \right)^{\varepsilon_{i,r,t}^{price}} \quad (5.1)$$

where

$$\bar{Q}_{i,r,t} = \frac{POP_{r,t}}{POP_{r,2000}} \times \left(\frac{GDP_{r,t}^{cap}}{GDP_{r,2000}^{cap}} \right)^{\varepsilon_{i,r,t}^{price}} \times \bar{Q}_{i,r,2000}$$

This demand function has the virtue of being easy to linearize as GLOBIOM is solved as a linear program. This is currently necessary because of the size of the model and the performance of non-linear solvers. However, this demand function has although some limitations which need to be kept in mind when considering the results obtained with respect to climate change mitigation and food availability. One of them is that it does not consider direct substitution effects on the consumer side which could be captured through cross price demand elasticities. Such a demand representation could lead to increased consumption of some products like legumes or cereals when prices of GHG intensive products like rice or beef would go up as a consequence of a carbon price targeting emissions for the agricultural sector. Neglecting the direct substitution effects may lead to an overestimation of the negative impact of such mitigation policies on total food consumption. However, the effect on emissions would be only of second order, because consumption would increase for commodities the least affected by the carbon price, and hence the least emission intensive. Although direct substitution effects on the demand side are not represented, substitution can still occur due to changes in prices on the supply side and can in some cases lead to a partial compensation of the decreased demand for commodities affected the most by a mitigation policy.

The water withdrawal and return flows from energy technologies are calculated in MESSAGE following the approach described in Fricko et al., (2016) [[18]]. Each technology is prescribed a water withdrawal and consumption intensity (e.g., m3 per kWh) that translates technology outputs optimized in MESSAGE into water requirements and return flows.

For power plant cooling technologies, the amount of water required and energy dissipated to water bodies as heat is linked to the parameterized power plant fuel conversion efficiency (heat rate). Looking at a simple thermal energy balance at the power plant (Fig. 6.1), total combustion energy (E_{comb}) is converted into electricity (E_{elec}), emissions (E_{emis}) and additional thermal energy that must be absorbed by the cooling system (E_{cool}):

$$E_{comb} = E_{elec} + E_{emis} + E_{cool}$$

Converting to per unit electricity, we can estimate the cooling required per unit of electricity generation (ϕ_{cool}) based on average heat-rate (ϕ_{comb}) and heat lost to emissions (ϕ_{emis}), and this data is identified from the literature [[18]].

$$\phi_{cool} = \phi_{comb} - \phi_{emis} - 1$$

With time-varying heat-rates (i.e., $t = 0, 1, 2, \dots$) and a constant share of energy to emissions and electricity:

$$\phi_{cool}[t] = \phi_{comb}[t] \cdot \left(1 - \frac{\phi_{emis}}{\phi_{comb}[0]} \right) - 1$$

Increased fuel efficiency (lower heat-rate) reduces the cooling requirement per unit of electricity generated. This enables heat rate improvements for power plants represented in MESSAGE to be translated into improvements in water intensity. Water withdrawal and consumption intensities for power plant cooling technologies are calibrated to the range reported in Meldrum et al., (2013) [[59]]. Additional parasitic electricity demands from recirculating and dry cooling technologies are accounted for explicitly in the electricity balance calculation. All other technologies follow the data reported in Fricko et al. (2016) [[18]].

A key feature of the implementation is the representation of power plant cooling technology options for individual power plant types (Fig. 6.2). Each power plant type that requires cooling in MESSAGE is connected to a corresponding cooling technology option (once-through, recirculating or air cooling), with the investment into and operation of the cooling technologies included in the optimization decision variables [[69]]. This enables MESSAGE to choose the type of cooling technology for each power plant type and track how the operation of the cooling technologies impact water withdrawals, return flows, thermal pollution and parasitic electricity use.

Costs and efficiency for cooling technologies are estimated following previous technology assessments [[50], [110], [111]]. The initial distribution of cooling technologies in each region and for each technology is estimated with the dataset described in Raptis and Pfister (2016) [[78]]. The shares estimated at the river basin-scale are depicted in Fig. 6.3 .

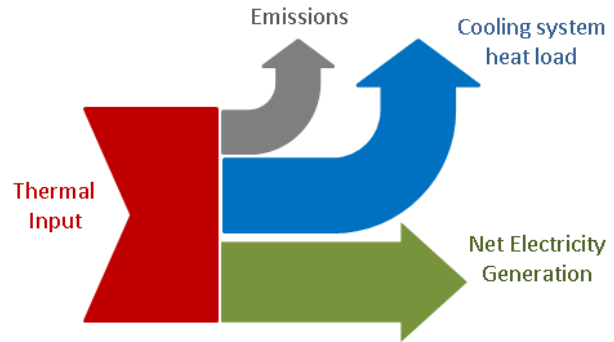

Fig. 6.1: Simplified power plant energy balance.

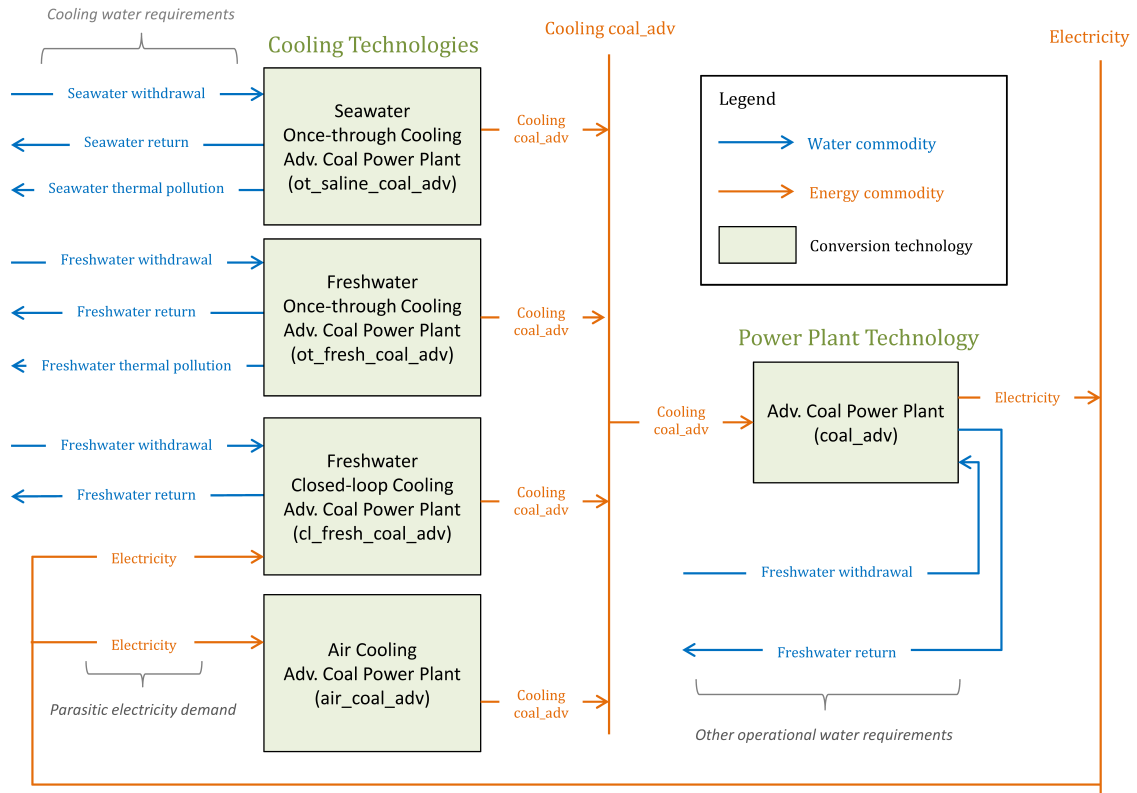

Fig. 6.2: Implementation of cooling technologies in the MESSAGE IAM.

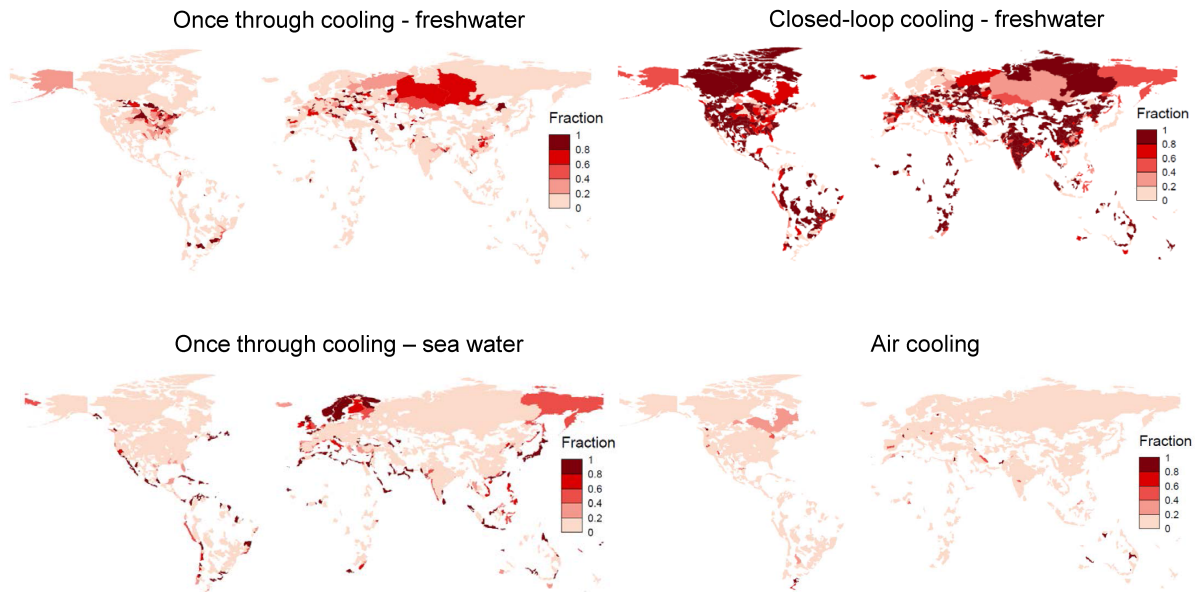

Fig. 6.3: Average cooling technology shares across all power plant types at the river basin-scale.

EMISSIONS

7.1 Emission from energy (MESSAGE)

7.1.1 Carbon-dioxide (CO₂)

The MESSAGE model includes a detailed representation of energy-related and - via the link to GLOBIOM - land-use CO₂ emissions (Riahi and Roehrl, 2000 [[82]]; Riahi, Rubin et al., 2004 [[83]]; Rao and Riahi, 2006 [[77]]; Riahi et al., 2011 [[81]]). CO₂ emission factors of fossil fuels and biomass are based on the 1996 version of the IPCC guidelines for national greenhouse gas inventories [[34]] (see Table 7.1). It is important to note that biomass is generally treated as being carbon neutral in the energy system, because the effects on the terrestrial carbon stocks are accounted for on the land use side, i.e. in GLOBIOM (see section *Land-use (GLOBIOM)*). The CO₂ emission factor of biomass is, however, relevant in the application of carbon capture and storage (CCS) where the carbon content of the fuel and the capture efficiency of the applied process determine the amount of carbon captured per unit of energy.

Table 7.1: Carbon emission factors used in MESSAGE based on IPCC (1996, Table 1-2 [34]). For convenience, emission factors are shown in three different units.

Fuel	Emission factor [tC/TJ]	Emission factor [tCO ₂ /TJ]	Emission factor [tC/kWyr]
Hard coal	25.8	94.6	0.814
Lignite	27.6	101.2	0.870
Crude oil	20.0	73.3	0.631
Light fuel oil	20.0	73.3	0.631
Heavy fuel oil	21.1	77.4	0.665
Methanol	17.4	63.8	0.549
Natural gas	15.3	56.1	0.482
Solid biomass	29.9	109.6	0.942

CO₂ emissions of fossil fuels for the entire energy system are accounted for at the resource extraction level by applying the CO₂ emission factors listed in Table 7.1 to the extracted fossil fuel quantities. In this economy-wide accounting, carbon emissions captured in CCS processes remove carbon from the balance equation, i.e. they contribute with a negative emission coefficient. In parallel, a sectoral accounting of CO₂ emissions is performed which applies the same emission factors to fossil fuels used in individual conversion processes. In addition to conversion processes, also CO₂ emissions from energy use in fossil fuel resource extraction are explicitly accounted for. A relevant feature of MESSAGE in this context is that CO₂ emissions from the extraction process increase when moving from conventional to unconventional fossil fuel resources (McJeon et al., 2014 [[55]]).

CO₂ mitigation options in the energy system include technology and fuel shifts; efficiency improvements; and CCS. A large number of specific mitigation technologies are modeled bottom-up in MESSAGE with a dynamic representation of costs and efficiencies. As mentioned above, MESSAGE also includes a detailed representation of carbon capture and sequestration from both fossil fuel and biomass combustion (see Table 7.2).

Table 7.2: Carbon capture rates in [%]

Conversion Process	Plant type	Capture rate
Electricity generation	supercritical PC power plant with desulphurization/denox and CCS	90%
Electricity generation	IGCC power plant with CCS	90%
Electricity generation	biomass IGCC power plant with CCS	86%
Liquid fuel production	Fischer-Tropsch coal-to-liquids with CCS	85%
Liquid fuel production	coal methanol-to-gasoline with CCS	85%
Liquid fuel production	Fischer-Tropsch gas-to-liquids with CCS	90%
Liquid fuel production	Fischer-Tropsch biomass-to-liquids with CCS	65%
Liquid fuel production	Biomass to Gasoline via the Methanol-to-Gasoline (MTG) Process with CCS	67%
Hydrogen production	coal gasification with CCS	92%
Hydrogen production	biomass gasification with CCS	85%
Hydrogen production	steam methane reforming with CCS	90%

7.1.2 Non-CO2 GHGs

MESSAGE includes a representation of non-CO2 GHGs (CH₄, N₂O, HFCs, SF₆, PFCs) mandated by the Kyoto Protocol (Rao and Riahi, 2006 [[77]]) with the exception of NF₃. Included is a representation of emissions and mitigation options from both energy related processes as well as non-energy sources like municipal solid waste disposal and wastewater. CH₄ and N₂O emissions from land are taken care of by the link to GLOBIOM (see Section *Emissions from land (GLOBIOM)*).

7.1.3 Air pollution

Air pollution implications are derived with the help of the GAINS (Greenhouse gas-Air pollution INteractions and Synergies) model. GAINS allows for the development of cost-effective emission control strategies to meet environmental objectives on climate, human health and ecosystem impacts until 2030 (Amann et al., 2011 [[3]]). These impacts are considered in a multi-pollutant context, quantifying the contributions of sulfur dioxide (SO₂), nitrogen oxides (NO_x), ammonia (NH₃), non-methane volatile organic compounds (VOC), and primary emissions of particulate matter (PM), including fine and coarse PM as well as carbonaceous particles (BC, OC). As a stand-alone model, it also tracks emissions of six greenhouse gases of the Kyoto basket with exception of NF₃. The GAINS model has global coverage and holds essential information about key sources of emissions, environmental policies, and further mitigation opportunities for about 170 country-regions. The model relies on exogenous projections of energy use, industrial production, and agricultural activity for which it distinguishes all key emission sources and several hundred control measures. GAINS can develop finely resolved mid-term air pollutant emission trajectories with different levels of mitigation ambition (Cofala et al., 2007 [[7]]; Amann et al., 2013 [[4]]). The results of such scenarios are used as input to global IAM frameworks to characterize air pollution trajectories associated with various long-term energy developments (see further for example Riahi et al., 2012 [[80]]; Rao et al., 2013 [[76]]; Fricko et al., 2017 [[17]]).

7.2 Emissions from land (GLOBIOM)

7.2.1 Crop sector emissions

Crop emissions sources accounted in GLOBIOM are N₂O fertilization emissions, from synthetic fertilizer and from organic fertilizers, as well as CH₄ methane emissions from rice cultivation. Synthetic fertilizers are calculated on a Tier 1 approach, using the information provided by EPIC on the fertilizer use for each management system at the Simulation Unit level and applying the emission factor from IPCC AFOLU guidelines. Synthetic fertilizer use is therefore built in a bottom up approach, but upscaled to the International Fertilizer Association statics on total fertilizer use per crop at the national level for the case where calculated fertilizers are found too low at the aggregated level. This correction ensures a full consistency with observed fertilizer purchases. In the case of rice, only a Tier 1

approach was applied, with a simple formula where emissions are proportional to the area of rice cultivated. Emission factor is taken from EPA (2012) [[12]].

7.2.2 Livestock emissions

In GLOBIOM, the following emission accounts were assigned to livestock directly: CH₄ from enteric fermentation, CH₄ and N₂O from manure management, and N₂O from excreta on pasture (N₂O from manure applied on cropland is reported in a separate account linked to crop production). In brief, CH₄ from enteric fermentation is a simultaneous output of the feed-yield calculations done with the RUMINANT model, as well as nitrogen content of excreta and the amount of volatile solids. The assumptions about proportions of different manure management systems, manure uses, and emission coefficients are based on detailed literature review. A detailed description of how these coefficients have been determined including the literature review is provided in (Herrero et al., 2013 [[27]]).

7.2.3 Land use change emissions

Land use change emissions are computed based on the difference between initial and final land cover equilibrium carbon stock. For forest, above and below-ground living biomass carbon data are sourced from Kindermann et al. (2008) [[43]], where geographically explicit allocation of the carbon stocks is provided. The carbon stocks are consistent with the 2010 Forest Assessment Report (FAO, 2010 [[15]]). Therefore, the emission factors for deforestation are in line with those of FAO. Additionally, carbon stock from grasslands and other natural vegetation is also taken into account using the above and below ground carbon from the biomass map from (Ruesch and Gibbs, 2008 [[92]]). When forest or natural vegetation is converted into agricultural use, it is considered in this approach that all below and above ground biomass is released in the atmosphere. However, the following are not accounted for: litter, dead wood and soil organic carbon.

7.2.4 Comparison with other literature

In order to put the numbers in perspective with other sources they were compared with FAO (Tubiello et al., 2013 [[105]]) where a simple but transparent approach is used, largely relying on FAOSTAT activity numbers and IPCC Tier 1 emission coefficients (see Table 7.3).

The 2000 data for crops are overall about 11% higher than Tubiello et al., mainly because of rice where the data are closer to EPA (EPA 2012 [[12]]) which is higher than Tubiello et al. For livestock, it is by some 18% lower than Tubiello et al. So in total there is about 10% GHG emissions less in 2000 than the values reported. The year 2010 is already the result of simulations and hence may be interesting to compare with the data. In order to facilitate the comparison, the columns e), f) and g) in Table 1 are included. Columns e) and f) compare GLOBIOM data for 2000 and projections for 2010 respectively, with numbers reported by Tubiello et al. Column g) compares the relative change in emissions between 2000 and 2010 from these two sources (1.00 would indicate the same relative change in GLOBIOM and in Tubiello et al.). It is apparent that the relative change in total agricultural emissions in GLOBIOM is the same as the development reported by Tubiello et al. – an increase by 11%. The behavior of GLOBIOM is over this period very close to the reported trends also at the level of individual accounts. The only exception is emissions from manure management where the relative change projected in GLOBIOM is by 13% higher than the relative change observed in Tubiello's numbers.

Table 7.3: Comparison of agricultural GHG emissions from GLOBIOM and from FAO for the years 2000 and 2010

	GLO-BIOM		Tubiello et al.				
	(a)	(b)	(c)	(d)	(e)	(f)	(g)
	2000	2010	2000	2010	2000	2010	2010/2000
Crops	1,239	1,365	1,114	1,298	1.11	1.05	0.95
Synthetic fertilizer	522	640	521	683	1.00	0.94	0.93
Manure applied	83	96	103	116	0.81	0.83	1.03
Rice	633	629	490	499	1.29	1.26	0.98
Livestock	2,362	2,625	2,893	3,135	0.82	0.84	1.03
Enteric fermentation	1,502	1,661	1,863	2,018	0.81	0.82	1.02
Manure on pastures	403	441	682	764	0.59	0.58	0.98
Manure management	457	524	348	353	1.31	1.48	1.13
Total Agriculture	3,601	3,991	4,007	4,433	0.90	0.90	1.00

CLIMATE (MAGICC)

The response of the carbon-cycle and climate to anthropogenic climate drivers is modelled with the MAGICC model (Model for the Assessment of Greenhouse-gas Induced Climate Change). MAGICC is a reduced-complexity coupled global climate and carbon cycle model which calculates projections for atmospheric concentrations of GHGs and other atmospheric climate drivers like air pollutants, together with consistent projections of radiative forcing, global annual-mean surface air temperature, and ocean-heat uptake (Meinshausen et al., 2011a [[57]]). MAGICC is an upwelling-diffusion, energy-balance model, which produces outputs for global- and hemispheric-mean temperature. MAGICC is most commonly used in a deterministic setup (Meinshausen et al., 2011b [[58]]), but also a probabilistic setup (Meinshausen et al., 2009 [[56]]) is available which allows to estimate the probabilities of limiting warming to below specific temperature levels given a specified emissions path (Rogelj et al., 2013a [[87]]; Rogelj et al., 2013b [[88]]; Rogelj et al., 2015 [[89]]). Climate feedbacks on the global carbon cycle are accounted for through the interactive coupling of the climate model and a range of gas-cycle models. (Fricko et al., 2017 [[17]])

For more information about the model, see www.magicc.org.

ANNEX: MATHEMATICAL FORMULATION

This mathematical formulation of MESSAGE-GLOBIOM relies on the generalized MESSAGEix energy model framework. See the [MESSAGEix documentation](#) for a complete description of its formulation. The equation system of the older MESSAGE V implementation can be found in the [2017 release](#) of this documentation.

FURTHER READING

1. Environmental Protection Agency (EPA). Global Mitigation of Non-CO₂ Greenhouse Gases: 2010-2030. 2013. URL: https://www3.epa.gov/climatechange/Downloads/EPAactivities/MAC_Report_2013.pdf.
2. Nikos Alexandratos and Jelle Bruinsma. World agriculture towards 2030/2050: the 2012 revision. Report 12-03, FAO, June 2012.
3. Markus Amann, Rafal Cabala, Janusz Cofala, Chris Heyes, Zbigniew Klimont, Wolfgang Schopp, Leonor Tarrason, David Simpson, Peter Wind, and Jan-Eiof Jonson. "Current Legislation" and the "Maximum Technically Feasible Reduction" cases for the CAFE baseline emission projections. *IIASA, Vienna*, 2004. URL: https://www.researchgate.net/profile/Zbigniew_Klimont/publication/230709494_The_Current_Legislation_and_the_Maximum_Technically_Feasible_Reduction_cases_for_the_CAFE_baseline_emission_projections._CAFE_Report__2/links/0deec53cd2d778aafb000000.pdf (visited on 2016-03-24).
4. Goran Berndes, Monique Hoogwijk, and Richard van den Broek. The contribution of biomass in the future global energy supply: a review of 17 studies. *Biomass and Bioenergy*, 25(1):1–28, 7 2003. doi:10.1016/S0961-9534(02)00185-X.
5. A.F. Bouwman, K.W. Van der Hoek, B. Eickhout, and I. Soenario. Exploring changes in world ruminant production systems. *Agricultural Systems*, 84(2):121 – 153, 2005. doi:10.1016/j.agry.2004.05.006.
6. Stefan Bringezu, Helmut Schutz, Meghan O'Brien, Lea Kauppi, Robert W Howarth, and Jeff McNeely. *Assessing biofuels: towards sustainable production and use of resources*. United Nations Environment Programme, 2009. ISBN 92-807-3052-5.
7. Veronika Dornburg, APC Faaij, PA Verweij, Martin Banse, Kees van Diepen, Herman van Keulen, Hans Langeveld, Marieke Meeusen, Gerrie van de Ven, and Flip Wester. Biomass assessment: assessment of global biomass potentials and their links to food, water, biodiversity, energy demand and economy: inventory and analysis of existing studies: supporting document. *Report/WAB*, 2008.
8. Bas Eickhout, Gert Jan van den Born, Jos Notenboom, M van Oorschoot, JPM Ros, DP Van Vuuren, and HJ Westhoek. Local and global consequences of the EU renewable directive for biofuels: Testing the sustainability criteria. *Local and global consequences of the EU renewable directive for biofuels: testing the sustainability criteria*, 2008.
9. RA Fischer, Derek Byerlee, and Gregory O Edmeades. Can technology deliver on the yield challenge to 2050? 2009. URL: <http://www.fao.org/3/a-ak542e/ak542e12a.pdf>.
10. Chris E Forest, Peter H Stone, Andrei P Sokolov, Myles R Allen, and Mort D Webster. Quantifying uncertainties in climate system properties with the use of recent climate observations. *Science*, 295(5552):113–117, 2002.
11. Claire Granier, Bertrand Bessagnet, Tami Bond, Ariela D'Angiola, Hugo Denier van Der Gon, Gregory J Frost, Angelika Heil, Johannes W Kaiser, Stefan Kinne, and Zbigniew Klimont. Evolution of anthropogenic and biomass burning emissions of air pollutants at global and regional scales during the 1980–2010 period. *Climatic Change*, 109(1-2):163–190, 2011.
12. Monique Hoogwijk and Wina Graus. Global potential of renewable energy sources: a literature assessment. *Background report prepared by order of REN21. Ecofys, PECSNL072975*, 2008.

13. Monique Maria Hoogwijk. *On the global and regional potential of renewable energy sources*. PhD, Department of Science, Technology and Society. Utrecht University, 2004.
14. IPCC. *Climate Change 2007: Synthesis Report. Contribution of Working Groups I, II and III to the Fourth Assessment Report of the Intergovernmental Panel on Climate Change*. IPCC, Geneva, Switzerland, 2007. URL: http://www.ipcc.ch/pdf/assessment-report/ar4/syr/ar4_syr_full_report.pdf.
15. Global Emissions Joint Research Centre. Emission Database for Global Atmospheric Research EDGAR v4.2. 11 2011. URL: <http://edgar.jrc.ec.europa.eu/overview.php?v=42>.
16. Ilkka Keppo, Brian C O'Neill, and Keywan Riahi. Probabilistic temperature change projections and energy system implications of greenhouse gas emission scenarios. *Technological Forecasting and Social Change*, 74(7):936–961, 2007.
17. Richard Loulou, Gary Goldstein, and Ken Noble. *Documentation for the MARKAL Family of Models - Part II: MARKAL-MACRO*. IEA Energy Technology Systems Analysis Programme (ETSAP), October 2004. URL: https://www.iea-etsap.org/MrklDoc-II_MARKALMACRO.pdf.
18. Malte Meinshausen. What does a 2 C target mean for greenhouse gas concentrations? A brief analysis based on multi-gas emission pathways and several climate sensitivity uncertainty estimates. *Avoiding dangerous climate change*, 2006.
19. Sanderine Nonhebel. Energy from agricultural residues and consequences for land requirements for food production. *Agricultural Systems*, 94(2):586–592, 2007.
20. B.C. O'Neill, T.R. Carter, K.L. Ebi, J. Edmonds, S. Hallegatte, E. Kemp-Benedict, E. Kriegler, L. Mearns, R. Moss, K. Riahi, B. van Ruijven, and D. van Vuuren. Meeting report of the workshop on the nature and use of new socioeconomic pathways for climate change research. Report, NCAR, November 2-4, 2011 2012. URL: <http://www.isp.ucar.edu/socio-economic-pathways>.
21. Andrew J Plantinga, Thomas Mauldin, and Douglas J Miller. An econometric analysis of the costs of sequestering carbon in forests. *American Journal of Agricultural Economics*, 81(4):812–824, 1999.
22. Shilpa Rao, Vadim Chirkov, Frank Dentener, Rita Van Dingenen, Shonali Pachauri, Pallav Purohit, Markus Amann, Chris Heyes, Patrick Kinney, and Peter Kolp. Environmental modeling and methods for estimation of the global health impacts of air pollution. *Environmental Modeling & Assessment*, 17(6):613–622, 2012.
23. Keywan Riahi, Arnulf Grubler, and Nebojsa Nakicenovic. Scenarios of long-term socio-economic and environmental development under climate stabilization. *Technological Forecasting and Social Change*, 74(7):887–935, 2007.
24. Dmitry Rokityanskiy, Pablo C Benitez, Florian Kraxner, Ian McCallum, Michael Obersteiner, Ewald Rametsteiner, and Yoshiki Yamagata. Geographically explicit global modeling of land-use change, carbon sequestration, and biomass supply. *Technological Forecasting and Social Change*, 74(7):1057–1082, 2007.
25. P. Russ, T. Wiesenenthal, D. van Regemorter, and J.C. Ciscar. Global climate policy scenarios for 2030 and beyond: analysis of greenhouse gas emission reduction pathway scenarios with the poles and game3 models. *Institute for Prospective technological Studies*, October, 2007.
26. Jayant Sathaye, Peter Chan, Larry Dale, Willy Makundi, and Ken Andrasko. A summary note estimating global forestry GHG mitigation potential and costs: A dynamic partial equilibrium approach. *working draft*, August, 10:448–457, 2003.
27. Jayant Sathaye, Willy Makundi, Larry Dale, Peter Chan, and Kenneth Andrasko. GHG mitigation potential, costs and benefits in global forests: a dynamic partial equilibrium approach. *The Energy Journal*, pages 127–162, 2006.
28. Timothy Searchinger, Ralph Heimlich, Richard A Houghton, Fengxia Dong, Amani Elobeid, Jacinto Fabiosa, Simla Tokgoz, Dermot Hayes, and Tun-Hsiang Yu. Use of US croplands for biofuels increases greenhouse gases through emissions from land-use change. *Science*, 319(5867):1238–1240, 2008.
29. Edward MW Smeets, Andre PC Faaij, Iris M Lewandowski, and Wim C Turkenburg. A bottom-up assessment and review of global bio-energy potentials to 2050. *Progress in Energy and combustion science*, 33(1):56–106, 2007.

30. Pete Smith, Peter J Gregory, Detlef Van Vuuren, Michael Obersteiner, Petr Havlik, Mark Rounsevell, Jeremy Woods, Elke Stehfest, and Jessica Bellarby. Competition for land. *Philosophical Transactions of the Royal Society of London B: Biological Sciences*, 365(1554):2941–2957, 2010.
31. Robert N Stavins. The costs of carbon sequestration: a revealed-preference approach. *The American Economic Review*, 89(4):994–1009, 1999.
32. Elke Stehfest, Lex Bouwman, Detlef P Van Vuuren, Michel GJ Den Elzen, Bas Eickhout, and Pavel Kabat. Climate benefits of changing diet. *Climatic change*, 95(1-2):83–102, 2009.
33. Francesco N Tubiello and Gunther Fischer. Reducing climate change impacts on agriculture: Global and regional effects of mitigation, 2000–2080. *Technological Forecasting and Social Change*, 74(7):1030–1056, 2007.
34. Jasper van Vliet, Maarten van den Berg, Michiel Schaeffer, Detlef P van Vuuren, Michel Den Elzen, Andries F Hof, Angelica Mendoza Beltran, and Malte Meinshausen. Copenhagen accord pledges imply higher costs for staying below 2 C warming. *Climatic Change*, 113(2):551–561, 2012.
35. Detlef van Vuuren, Washington Ochola, Susan Riha, Mario Giampietro, Hector Ginzo, Thomas Henrichs, Sajidin Hussain Hussain, Kaspar Kok, Moraka Makhura Makhura, and Monirul Mirza. Outlook on agricultural changes and its drivers. In *Agriculture at a Crossroads-the Global Report of the International Assessment of Agricultural Knowledge, Science, and Technology*. Island Press, 2009.
36. Detlef P Van Vuuren, Elie Bellevrat, Alban Kitous, and Morna Isaac. Bio-energy use and low stabilization scenarios. *The Energy Journal*, pages 193–221, 2010.
37. Detlef P Van Vuuren, Jasper van Vliet, and Elke Stehfest. Future bio-energy potential under various natural constraints. *Energy Policy*, 37(11):4220–4230, 2009.
38. Tom ML Wigley. MAGICC/SCENGEN 5.3: User manual (version 2). NCAR, Boulder, CO, 2008.

BIBLIOGRAPHY

- [1] International Energy Agency. Energy Balances. Technical Report, International Energy Agency, 2012.
- [2] International Energy Agency. World Energy Outlook 2014. Technical Report, International Energy Agency, 2014. URL: <http://www.worldenergyoutlook.org/weo2014/>.
- [3] Markus Amann, Imrich Bertok, Jens Borken-Kleefeld, Janusz Cofala, Chris Heyes, Lena Hoglund-Isaksson, Zbigniew Klimont, Binh Nguyen, Maximilian Posch, Peter Rafaj, Robert Sandler, Wolfgang Schopp, Fabian Wagner, and Wilfried Winiwarter. Cost-effective control of air quality and greenhouse gases in Europe: Modeling and policy applications. *Environmental Modelling & Software*, 26(12):1489–1501, 12 2011. doi:10.1016/j.envsoft.2011.07.012.
- [4] Markus Amann, Zbigniew Klimont, and Fabian Wagner. Regional and global emissions of air pollutants: Recent trends and future scenarios. *Annual Review of Environment and Resources*, 38:31–55, 2013.
- [5] A. E. Carpentieri, E. D. Larson, and J. Woods. Future biomass-based electricity supply in northeast brazil. *Biomass and Bioenergy*, 4(3):149–173, 1993. URL: <http://www.scopus.com/scopus/inward/record.url?eid=2-s2.0-0027382662&partnerID=40&rel=R8.2.0>.
- [6] Lena Christiansson. Diffusion and learning curves of renewable-energy technologies. *IIASA Report*, 1995.
- [7] Janusz Cofala, Markus Amann, Zbigniew Klimont, Kaarle Kupiainen, and Lena Hoglund-Isaksson. Scenarios of global anthropogenic emissions of air pollutants and methane until 2030. *Atmospheric Environment*, 41(38):8486–8499, 2007.
- [8] Richard T. Conant and Keith Paustian. Grassland management activity data: current sources and future needs. *Environmental Management*, 33(4):467–473, 2004. doi:10.1007/s00267-003-9104-7.
- [9] Rob Dellink, Jean Chateau, Elisa Lanzi, and Bertrand Magne. Long-term economic growth projections in the Shared Socioeconomic Pathways. *Global Environmental Change*, 2015. URL: <http://pure.iiasa.ac.at/13280/>.
- [10] UN Population Division. World Population Projection. Technical Report, UN, 2010.
- [11] Tommi Ekholm, Volker Krey, Shonali Pachauri, and Keywan Riahi. Determinants of household energy consumption in India. *Energy Policy*, 38(10):5696–5707, 2010.
- [12] EPA. Us environmental protection agency global emissions database. Report, US Environmental Protection Agency, 2012. URL: <http://www.epa.gov/climatechange/ghgemissions/global.html>.
- [13] K. Eurek, P. Sullivan, M. Gleason, D. Hettinger, D.M. Heimiller, and A. Lopez. An improved global wind resource estimate for integrated assessment models. *Energy Economics*, 64:552–567, 2017.
- [14] FAO. Global forest resources assessment 2005. progress towards sustainable forest management. Report, Food and Agriculture Organization of the United Nations, 2006.
- [15] FAO. Global forest resources assessment. Report, Food and Agriculture Organization of the United Nations, 2010. URL: <http://www.fao.org/forestry/fra/fra2010/en/>.
- [16] FPP. Holzernte in der durchforstung; leistungszahlen kosten - oebf seiltabelle sortimentverfahren (skm-tab). Report, Kooperationsabkommen Forst-Platte-Papier, 1999.
- [17] Oliver Fricko, Petr Havlik, Joeri Rogelj, Zbigniew Klimont, Mykola Gusti, Nils Johnson, Peter Kolp, Manfred Strubegger, Hugo Valin, Markus Amann, Tatiana Ermolieva, Nicklas Forsell, Mario Herrero, Chris Heyes,

- Georg Kindermann, Volker Krey, David L. McCollum, Michael Obersteiner, Shonali Pachauri, Shilpa Rao, Erwin Schmid, Wolfgang Schoepp, and Keywan Riahi. The marker quantification of the shared socioeconomic pathway 2: a middle-of-the-road scenario for the 21st century. *Global Environmental Change*, 42:251–267, 2017.
- [18] Oliver Fricko, Simon C Parkinson, Nils Johnson, Manfred Strubegger, Michelle TH van Vliet, and Keywan Riahi. Energy sector water use implications of a 2 °C climate policy. *Environmental Research Letters*, 11(3):034011, 2016.
- [19] Steffen Fritz, Linda See, Ian McCallum, Christian Schill, Michael Obersteiner, Marijn van der Velde, Hannes Boettcher, Petr Havlik, and Frederic Achard. Highlighting continued uncertainty in global land cover maps for the user community. *Environmental Research Letters*, 6(4):044005, 2011. URL: <http://stacks.iop.org/1748-9326/6/i=4/a=044005>.
- [20] Biomass Technology Group. *Handbook Biomass Gasification*. H.A.M. Knoef. ISBN: 90-810068-1-9, 2005.
- [21] A. Grubler, C. Wilson, N. Bento, B. Boza-Kiss, V. Krey, D.L. McCollum, N.D. Rao, K. Riahi, J. Rogelj, S. De Stercke, J. Cullen, S. Frank, O. Fricko, F. Guo, M. Gidden, P. Havlik, D. Huppmann, G. Kiesewetter, P. Rafaj, W. Schoepp, and H. Valin. A low energy demand scenario for meeting the 1.5 °C target and sustainable development goals without negative emission technologies. *Nature Energy*, 3(6):515–527, 2018. doi:10.1038/s41560-018-0172-6.
- [22] MI Gusti. An algorithm for simulation of forest management decisions in the global forest model. *Искусственный интеллект*, 2010.
- [23] C.N. Hamelinck and A.P.C. Faaij. Future prospects for production of methanol and hydrogen from biomass. Report, Utrecht University, Copernicus Institute, Science Technology and Society, 2001.
- [24] B. R. Hartsough, X. Zhang, and R. D. Fight. Harvesting cost model for small trees in natural stands in the interior northwest. *Forest Products Journal*, 51(4):54–61, 2001. URL: <http://www.scopus.com/scopus/inward/record.url?eid=2-s2.0-0035306334&partnerID=40&rel=R8.2.0>.
- [25] Petr Havlik, Uwe A Schneider, Erwin Schmid, Hannes Bottcher, Steffen Fritz, Rastislav Skalsky, Kentaro Aoki, Stephane De Cara, Georg Kindermann, and Florian Kraxner. Global land-use implications of first and second generation biofuel targets. *Energy Policy*, 39(10):5690–5702, 2011.
- [26] Petr Havlik, Hugo Valin, Mario Herrero, Michael Obersteiner, Erwin Schmid, Mariana C Rufino, Aline Mosnier, Philip K Thornton, Hannes Bottcher, and Richard T Conant. Climate change mitigation through livestock system transitions. *Proceedings of the National Academy of Sciences*, 111(10):3709–3714, 2014.
- [27] M. Herrero, P. Havlik, H. Valin, M.C. Rufino, A.M.O. Notenbaert, P.K. Thornton, M. Blummel, F. Weiss, and M. Obersteiner. Global livestock systems: biomass use, production, feed efficiencies and greenhouse gas emissions. *Proceedings of the National Academy of Sciences*, 110(52):20888–20893, 2013.
- [28] M. Herrero, P.K. Thornton, R. Kruska, and R.S. Reid. Systems dynamics and the spatial distribution of methane emissions from african domestic ruminants to 2030. *Agriculture, Ecosystems & Environment*, 126(1-2):122 – 137, 2008. URL: <http://www.sciencedirect.com/science/article/pii/S0167880908000121>.
- [29] GmbH Herzogbaum. Forstpflanzen-preisliste 2008. herzog.baum samen & pflanzen gmbh. koaserbauerstr. 10, a - 4810 gmunden. austria (also available at www.energiehoelzer.at). 2008.
- [30] A. Heston, R. Summers, and B. Aten. Penn world table version 6.2. Report, Center for International Comparisons of Production, Income and Prices at the University of Pennsylvania. September 2006. http://pwt.econ.upenn.edu/php_site/pwt62/pwt62_form.php, 2006.
- [31] Daniel Huppmann, Matthew Gidden, Oliver Fricko, Peter Kolp, Clara Orthofer, Michael Pimmer, Nikolay Kushin, Adriano Vinca, Alessio Mastrucci, Keywan Riahi, and Volker Krey. The messageix integrated assessment model and the ix modeling platform (ixmp): an open framework for integrated and cross-cutting analysis of energy, climate, the environment, and sustainable development. *Environmental Modelling & Software*, 112:143–156, 2019. doi:10.1016/j.envsoft.2018.11.012.
- [32] IEA. World energy model - investment costs. Report, International Energy Agency (IEA), 2014. URL: <http://www.worldenergyoutlook.org/media/weowebiste/2014/weio/WEIO2014PGAssumptions.xlsx>.
- [33] ILO. Occupational wages and hours of work and retail food prices, statistics from the ilo october inquiry. Report, International Labor Organisation, 2007.

- [34] IPCC. *Revised 1996 IPCC Guidelines for National Greenhouse Gas Inventories: The Workbook (Volume 2)*. IPCC, Geneva, Switzerland, 1996. URL: <http://www.ipcc-nggip.iges.or.jp/public/gl/invs5a.html>.
- [35] R. C. Izaurralde, J. R. Williams, W. B. McGill, N. J. Rosenberg, and M. C. Q. Jakas. Simulating soil c dynamics with epic: model description and testing against long-term data. *Ecological Modelling*, 192(3-4):362–384, 2006. URL: <http://www.scopus.com/scopus/inward/record.url?eid=2-s2.0-31944437556&partnerID=40&rel=R8.2.0>.
- [36] Jessica Jewell, David McCollum, Johannes Emmerling, Christoph Bertram, David E. H. J. Gernaat, Volker Krey, Leonidas Paroussos, Loic Berger, Kostas Fragkiadakis, Ilkka Keppo, Nawfal Saadi, Massimo Tavoni, Detlef van Vuuren, Vadim Vinichenko, and Keywan Riahi. Limited emission reductions from fuel subsidy removal except in energy exporting regions. *Nature*, 554(10):229, 2018.
- [37] R. Jiroušek, R. Klvač, and A. Skoupý. Productivity and costs of the mechanised cut-to-length wood harvesting system in clear-felling operations. *Journal of Forest Science*, 53(10):476–482, 2007. URL: <http://www.scopus.com/scopus/inward/record.url?eid=2-s2.0-35448931938&partnerID=40&rel=R8.2.0>.
- [38] Nils Johnson, Manfred Strubegger, Madleine McPherson, Simon Parkinson, Volker Krey, and Patrick Sullivan. A reduced-form approach for representing the impacts of wind and solar pv deployment on the structure and operation of the electricity system. *Energy Economics*, 2016.
- [39] Mike Jurvelius. Labor-intensive harvesting of tree plantations in the southern philippines. forest harvesting case -study 9. rap publication: 1997/41. Report, Food and Agriculture Organization of the United Nations, 1997.
- [40] Samir KC and Wolfgang Lutz. The human core of the shared socioeconomic pathways: Population scenarios by age, sex and level of education for all countries to 2100. *Global Environmental Change*, 2014.
- [41] Ilkka Keppo and Manfred Strubegger. Short term decisions for long term problems—The effect of foresight on model based energy systems analysis. *Energy*, 35(5):2033–2042, 2010.
- [42] M.A. Keyzer, M.D. Merbis, I.F.P.W. Pavel, and C.F.A. van Wesenbeeck. Diet shifts towards meat and the effects on cereal use: can we feed the animals in 2030? *Ecological Economics*, 55(2):187–202, 2005. URL: <http://www.sciencedirect.com/science/article/pii/S0921800904004100>.
- [43] G. Kindermann, M. Obersteiner, B. Sohngen, J. Sathaye, K. Andrasko, E. Rametsteiner, B. Schlamadinger, S. Wunder, and R. Beach. Global cost estimates of reducing carbon emissions through avoided deforestation. *Proceedings of the National Academy of Sciences*, 105(30):10302, 2008.
- [44] G. E. Kindermann, I. McCallum, S. Fritz, and M. Obersteiner. A global forest growing stock, biomass and carbon map based on fao statistics. *Silva Fennica*, 42(3):387–396, 2008. URL: <http://www.scopus.com/scopus/inward/record.url?eid=2-s2.0-46249088682&partnerID=40&rel=R8.2.0>.
- [45] Georg E Kindermann, Michael Obersteiner, Ewald Rametsteiner, and Ian McCallum. Predicting the deforestation-trend under different carbon-prices. *Carbon Balance and management*, 1(1):15, 2006.
- [46] Volker Krey and Keywan Riahi. Implications of delayed participation and technology failure for the feasibility, costs, and likelihood of staying below temperature targets—Greenhouse gas mitigation scenarios for the 21st century. *Energy Economics*, 31:S94–S106, 2009.
- [47] Eric D. Larson, Zheng Li, and Robert H. Williams. Chapter 12 - Fossil Energy. In *Global Energy Assessment - Toward a Sustainable Future*, pages 901–992. Cambridge University Press, Cambridge, UK and New York, NY, USA and the International Institute for Applied Systems Analysis, Laxenburg, Austria, 2012. URL: www.globalenergyassessment.org.
- [48] S. Leduc, D. Schwab, E. Dotzauer, E. Schmid, and M. Obersteiner. Optimal location of wood gasification plants for methanol production with heat recovery. *International Journal of Energy Research*, 32:1080–1091 [2008], 2008.
- [49] Benjamin D. Leibowicz. Growth and competition in renewable energy industries: insights from an integrated assessment model with strategic firms. *Energy Economics*, 52, Part A:13 – 25, 2015. doi:10.1016/j.eneco.2015.09.010.
- [50] Aviva Loew, Paulina Jaramillo, and Haibo Zhai. Marginal costs of water savings from cooling system retrofits: A case study for Texas power plants. *Environmental Research Letters*, 11(10):104004, 2016.

- [51] Alan Sussmann Manne and Richard G Richels. *Buying greenhouse insurance: the economic costs of carbon dioxide emission limits*. MIT press, 1992. ISBN 0-262-13280-X.
- [52] Bruce A. McCarl and Thomas H. Spreen. Price endogenous mathematical programming as a tool for sector analysis. *American Journal of Agricultural Economics*, 62(1):87–102, 1980. URL: <http://www.jstor.org/stable/1239475>.
- [53] D.L. McCollum, W. Zhou, C. Bertram, H.-S. De Boer, V. Bosetti, S. Busch, J. Després, L. Drouet, J. Emmerling, M. Fay, O. Fricko, S. Fujimori, M. Gidden, M. Harmsen, D. Huppmann, G. Iyer, V. Krey, E. Kriegler, C. Nicolas, S. Pachauri, S. Parkinson, M. Poblete-Cazenave, P. Rafaj, N. Rao, J. Rozenberg, A. Schmitz, W. Schoepp, D. Van Vuuren, and K. Riahi. Energy investment needs for fulfilling the paris agreement and achieving the sustainable development goals. *Nature Energy*, 3(7):589–599, 2018. doi:10.1038/s41560-018-0179-z.
- [54] David L. McCollum, Charlie Wilson, Hazel Pettifor, Kalai Ramea, Volker Krey, Keywan Riahi, Christoph Bertram, Zhenhong Lin, Oreane Y. Edelenbosch, and Sei Fujisawa. Improving the behavioral realism of global integrated assessment models: an application to consumers’ vehicle choices. *Transportation Research Part D: Transport and Environment*, 2016.
- [55] Haewon McJeon, Jae Edmonds, Nico Bauer, Leon Clarke, Brian Fisher, Brian P. Flannery, Jerome Hilaire, Volker Krey, Giacomo Marangoni, Raymond Mi, Keywan Riahi, Holger Rogner, and Massimo Tavoni. Limited impact on decadal-scale climate change from increased use of natural gas. *Nature*, 514(7523):482–485, 2014.
- [56] Malte Meinshausen, Nicolai Meinshausen, William Hare, Sarah CB Raper, Katja Frieler, Reto Knutti, David J Frame, and Myles R Allen. Greenhouse-gas emission targets for limiting global warming to 2 C. *Nature*, 458(7242):1158–1162, 2009.
- [57] Malte Meinshausen, SCB Raper, and TML Wigley. Emulating coupled atmosphere-ocean and carbon cycle models with a simpler model, MAGICC6–Part 1: Model description and calibration. *Atmospheric Chemistry and Physics*, 11(4):1417–1456, 2011.
- [58] Malte Meinshausen, Steven J Smith, K Calvin, John S Daniel, MLT Kainuma, JF Lamarque, K Matsumoto, SA Montzka, SCB Raper, and K Riahi. The RCP greenhouse gas concentrations and their extensions from 1765 to 2300. *Climatic change*, 109(1-2):213–241, 2011.
- [59] James Meldrum, Syndi Nettles-Anderson, Garvin Heath, and Jordan Macknick. Life cycle water use for electricity generation: A review and harmonization of literature estimates. *Environmental Research Letters*, 8(1):015031, 2013.
- [60] Sabine Messner. Endogenized technological learning in an energy systems model. *Journal of Evolutionary Economics*, 7(3):291–313, 1997.
- [61] Sabine Messner and Leo Schrattenholzer. MESSAGE–MACRO: linking an energy supply model with a macroeconomic module and solving it iteratively. *Energy*, 25(3):267–282, 2000.
- [62] Sabine Messner and Manfred Strubegger. User’s Guide for MESSAGE III. 1995. URL: <http://pure.iiasa.ac.at/id/eprint/4527/1/WP-95-069.pdf>.
- [63] Timothy D. Mitchell and Philip D. Jones. An improved method of constructing a database of monthly climate observations and associated high-resolution grids. *International Journal of Climatology*, 25(6):693–712, 2005. doi:10.1002/joc.1181.
- [64] A. Muhammad, J. Seale, B. Meade, and A. Regmi. International evidence on food consumption patterns: an update using 2005 international comparison program data. Report 1929, USDA-ERS, 2011.
- [65] Brian C O’Neill, Elmar Kriegler, Kristie L Ebi, Eric Kemp-Benedict, Keywan Riahi, Dale S Rothman, Bas J van Ruijven, Detlef P van Vuuren, Joern Birkmann, and Kasper Kok. The roads ahead: narratives for shared socioeconomic pathways describing world futures in the 21st century. *Global Environmental Change*, 2015.
- [66] Brian C O’Neill, Elmar Kriegler, Keywan Riahi, Kristie L Ebi, Stephane Hallegatte, Timothy R Carter, Ritu Mathur, and Detlef P van Vuuren. A new scenario framework for climate change research: the concept of shared socioeconomic pathways. *Climatic Change*, 122(3):387–400, 2014.
- [67] Brian C O’Neill, Keywan Riahi, and Ilkka Keppo. Mitigation implications of midcentury targets that preserve long-term climate policy options. *Proceedings of the National Academy of Sciences*, 107(3):1011–1016, 2010.

- [68] Shonali Pachauri, Bas J van Ruijven, Yu Nagai, Keywan Riahi, Detlef P van Vuuren, Abeeku Brew-Hammond, and Nebojsa Nakicenovic. Pathways to achieve universal household access to modern energy by 2030. *Environmental Research Letters*, 8(2):024015, 2013.
- [69] Simon Parkinson, Volker Krey, Daniel Huppmann, Taher Kahil, David McCollum, Oliver Fricko, Edward Byers, Matthew J Gidden, Beatriz Mayor, Zarrar Khan, and others. Balancing clean water-climate change mitigation trade-offs. *Environmental Research Letters*, 14(1):014009, 2019.
- [70] W. J. Parton, J. M. O. Scurlock, D. S. Ojima, T. G. Gilmanov, R. J. Scholes, D. S. Schimel, T. Kirchner, J. C. Menaut, T. Seastedt, E. G. Moya, A. Kamnalrut, and J. I. Kinyamario. Observations and modeling of biomass and soil organic-matter dynamics for the grassland biome worldwide. *Global Biogeochemical Cycles*, 7:785–809, 1993.
- [71] WJ Parton, DS Schimel, DS Ojima, and CV Cole. Analysis of factors controlling soil organic matter levels in great plains grasslands. *Soil Science Society of America Journal*, 51(5):1173–1179, 1987.
- [72] R. C. Pietzcker, D. Stetter, S. Manger, and G. Luderer. Using the sun to decarbonize the power sector: the economic potential of photovoltaics and concentrating solar power. *Applied Energy*, 135:704–720, 2014.
- [73] N. Ramankutty, A.T. Evan, C. Monfreda, and J.A. Foley. Farming the planet: 1. geographic distribution of global agricultural lands in the year 2000. *Global Biogeochemical Cycles*, 22(1):1–19, 2008.
- [74] E Rametsteiner, S Nilsson, H Bottcher, P Havlik, F Kraxner, S Leduc, M Obersteiner, F Rydzak, U Schneider, D Schwab, and L Willmore. Study of the effects of globalization on the economic viability of eu forestry. final report of the agri tender project: agri-g4-2006-06 [2007]. ec contract number 30-ce-0097579/00-89. Report, EC/IIASA, 2007. URL: http://ec.europa.eu/agriculture/analysis/external/viability_forestry/index_en.htm.
- [75] S. Rao, Z. Klimont, S.J. Smith, R. Van Dingenen, F. Dentener, L. Bouwman, K. Riahi, M. Amann, B.L. Bodirsky, D.P. van Vuuren, L. Aleluia Reis, K. Calvin, L. Drouet, O. Fricko, S. Fujimori, D. Gernaat, P. Havlik, M. Harmsen, T. Hasegawa, C. Heyes, J. Hilaire, G. Luderer, T. Masui, E. Stehfest, J. Streffler, S. van der Sluis, and M. Tavoni. Future air pollution in the shared socio-economic pathways. *Global Environmental Change*, 42:346–358, 2017. doi:10.1016/j.gloenvcha.2016.05.012.
- [76] Shilpa Rao, Shonali Pachauri, Frank Dentener, Patrick Kinney, Zbigniew Klimont, Keywan Riahi, and Wolfgang Schoepp. Better air for better health: Forging synergies in policies for energy access, climate change and air pollution. *Global environmental change*, 23(5):1122–1130, 2013.
- [77] Shilpa Rao and Keywan Riahi. The Role of Non-CO₂ Greenhouse Gases in Climate Change Mitigation: Long-term Scenarios for the 21st Century. *The Energy Journal*, pages 177–200, 2006.
- [78] Catherine E. Raptis and Stephan Pfister. Global freshwater thermal emissions from steam-electric power plants with once-through cooling systems. *Energy*, 97:46–57, 2016.
- [79] CA Reynolds, TJ Jackson, and WJ Rawls. Estimating soil water-holding capacities by linking the food and agriculture organization soil map of the world with global pedon databases and continuous pedotransfer functions. *Water Resources Research*, 36(12):3653–3662, 2000.
- [80] Keywan Riahi, Frank Dentener, Dolf Gielen, Arnulf Grubler, Jessica Jewell, Zbigniew Klimont, Volker Krey, David McCollum, Shonali Pachauri, Shilpa Rao, Bas van Ruijven, Detlef P. van Vuuren, and Charlie Wilson. Chapter 17 - Energy Pathways for Sustainable Development. In *Global Energy Assessment - Toward a Sustainable Future*, pages 1203–1306. Cambridge University Press, Cambridge, UK and New York, NY, USA and the International Institute for Applied Systems Analysis, Laxenburg, Austria, 2012. URL: <http://www.globalenergyassessment.org>.
- [81] Keywan Riahi, Shilpa Rao, Volker Krey, Cheolhung Cho, Vadim Chirkov, Guenther Fischer, Georg Kindermann, Nebojsa Nakicenovic, and Peter Rafaj. RCP 8.5—A scenario of comparatively high greenhouse gas emissions. *Climatic Change*, 109(1-2):33–57, 2011.
- [82] Keywan Riahi and R Alexander Roehrl. Greenhouse gas emissions in a dynamics-as-usual scenario of economic and energy development. *Technological Forecasting and Social Change*, 63(2):175–205, 2000.
- [83] Keywan Riahi, Edward S Rubin, and Leo Schratzenholzer. Prospects for carbon capture and sequestration technologies assuming their technological learning. *Energy*, 29(9):1309–1318, 2004.
- [84] Keywan Riahi, Detlef P. van Vuuren, Elmar Kriegler, Jae Edmonds, Brian O'Neill, Shinichiro Fujimori, Nico Bauer, Katherine Calvin, Rob Dellink, Oliver Fricko, Wolfgang Lutz, Alexander Popp, Jesus Crespo

- Cuaresma, Samir KC, Marian Leimbach, Leiwen Jiang, Tom Kram, Shilpa Rao, Johannes Emmerling, Kristie Ebi, Tomoko Hasegawa, Petr Havlik, Florian Humpenoder, Lara Aleluia Da Silva, Steve Smith, Elke Stehfest, Valentina Bosetti, Jiyong Eom, David Gernaat, Toshihiko Masui, Joeri Rogelj, Jessica Strefler, Laurent Drouet, Volker Krey, Gunnar Luderer, Mathijs Harmsen, Kiyoshi Takahashi, Lavinia Baumstark, Jonathan Doelman, Mikiko Kainuma, Zbigniew Klimont, Giacomo Marangoni, Hermann Lotze-Campen, Michael Obersteiner, Andrzej Tabeau, and Massimo Tavoni. The Shared Socioeconomic Pathways and their Energy, Land Use, and Greenhouse Gas Emissions Implications. *Global Environmental Change*, 42:153–168, 2017. URL: <http://pure.iiasa.ac.at/13280/>, doi:10.1016/j.gloenvcha.2016.05.009.
- [85] M. Roelfsema, H. L. van Soest, M. Harmsen, D. P. van Vuuren, C. Bertram, M. den Elzen, N. Höhne, G. Jacobuta, V. Krey, E. Kriegler, G. Luderer, K. Riahi, F. Ueckerdt, J. Després, L. Drouet, J. Emmerling, S. Frank, O. Fricko, M. Gidden, F. Humpenöder, D. Huppmann, S. Fujimori, K. Fragkiadakis, K. Gi, K. Keramidis, A. C. Köberle, L. Aleluia Reis, P. Rochedo, R. Schaeffer, K. Oshiro, Z. Vrontisi, W. Chen, G. C. Iyer, J. Edmonds, M. Kannavou, K. Jiang, R. Mathur, G. Safonov, and S. S. Vishwanathan. Taking stock of national climate policies to evaluate implementation of the paris agreement. *Nature Communications*, 2020. doi:<https://doi.org/10.1038/s41467-020-15414-6>.
- [86] Joeri Rogelj, Oliver Fricko, Malte Meinshausen, Volker Krey, Johanna Zilliacus, and Keywan Riahi. Understanding the origin of paris agreement emission uncertainties. *Nature Communication*, pages 15748, 2017.
- [87] Joeri Rogelj, David L McCollum, Brian C O'Neill, and Keywan Riahi. 2020 emissions levels required to limit warming to below 2 [thinsp][deg] C. *Nature Climate Change*, 3(4):405–412, 2013.
- [88] Joeri Rogelj, David L McCollum, Andy Reisinger, Malte Meinshausen, and Keywan Riahi. Probabilistic cost estimates for climate change mitigation. *Nature*, 493(7430):79–83, 2013.
- [89] Joeri Rogelj, Andy Reisinger, David L McCollum, Reto Knutti, Keywan Riahi, and Malte Meinshausen. Mitigation choices impact carbon budget size compatible with low temperature goals. *Environmental Research Letters*, 10(7):075003, 2015.
- [90] H Rogner, Roberto F Aguilera, Christina Archer, Ruggero Bertani, S Bhattacharya, M Dusseault, Luc Gagnon, H Harbel, Monique Hoogwijk, and Arthur Johnson. Chapter 7 - Energy resources and potentials. In *Global Energy Assessment - Toward a Sustainable Future*, pages 423–512. Cambridge University Press, Cambridge, UK and New York, NY, USA and the International Institute for Applied Systems Analysis, Laxenburg, Austria, 2012.
- [91] Hans-Holger Rogner. An assessment of world hydrocarbon resources. *Annual review of energy and the environment*, 22(1):217–262, 1997.
- [92] Aaron Ruesch and Holly K. Gibbs. New ipcc tier-1 global biomass carbon map for the year 2000. Report, Oak Ridge National Laboratory, 2008. URL: http://cdiac.ornl.gov/epubs/ndp/global_carbon/carbon_documentation.html.
- [93] T. Sauer, P. Havlik, G. Kindermann, and U.A. . Schneider. Agriculture, population, land and water scarcity in a changing world - the role of irrigation. In *Congress of the European Association of Agricultural Economists*. 2008.
- [94] Andreas Schafer. Structural change in energy use. *Energy Policy*, 33(4):429–437, 2005.
- [95] A. L. Schloss, D. W. Kicklighter, J. Kaduk, U. Wittenberg, and The Participants of the Potsdam NPP Model Comparison. Comparing global models of terrestrial net primary productivity (npp): comparison of npp to climate and the normalized difference vegetation index (ndvi). *Global Change Biology*, 5(S1):25–34, 1999. doi:10.1046/j.1365-2486.1999.00004.x.
- [96] Erich A Schneider and William C Sailor. Long-term uranium supply estimates. *Nuclear Technology*, 162(3):379–387, 2008.
- [97] Uwe A. Schneider, Bruce A. McCarl, and Erwin Schmid. Agricultural sector analysis on greenhouse gas mitigation in us agriculture and forestry. *Agricultural Systems*, 94(2):128 – 140, 2007. URL: <http://www.sciencedirect.com/science/article/pii/S0308521X06001028>.
- [98] James Seale, Anita Regmi, and Jason Bernstein. International evidence on food consumption patterns. Report 1904, USDA-ERS, October 2003. URL: <http://www.ers.usda.gov/Data/InternationalFoodDemand/>.

- [99] C. Sere and H. Steinfeld. World livestock production systems: current status, issues and trends. Report 127, Food and Agriculture Organisation, 1996. URL: <http://www.fao.org/WAIRDOCS/LEAD/X6101E/X6101E00.HTM>.
- [100] R. Skalsky, Z. Tarasovicova, J. Balkovic, E. Schmid, M. Fuchs, E. Moltchanova, G. Kindermann, and P. Scholtz. Geo-bene global database for bio-physical modeling v.1.0. concepts, methodologies and data. technical report. Report, IIASA, accessed 13.03.09 2008. URL: <http://www.geo-bene.eu/?q=node/1734S>.
- [101] A. L. Sorensen. Economies of scale in biomass gasification systems. Report Interim Report IR-05-030, IIASA, 2005.
- [102] B. J. Stokes, D. J. Frederick, and D. T. Curtin. Field trials of a short-rotation biomass feller buncher and selected harvesting systems. *Biomass*, 11(3):185–204, 1986. URL: <http://www.scopus.com/scopus/inward/record.url?eid=2-s2.0-0022984004&partnerID=40&rel=R8.2.0>.
- [103] Patrick Sullivan, Volker Krey, and Keywan Riahi. Impacts of considering electric sector variability and reliability in the message model. *Energy Strategy Reviews*, 1(3):157–163, 2013.
- [104] T. Takayama and G.G. Judge. *Spatial and temporal price and allocation models*. North-Holland Amsterdam, 1971.
- [105] Francesco N Tubiello, Mirella Salvatore, Simone Rossi, Alessandro Ferrara, Nuala Fitton, and Pete Smith. The faostat database of greenhouse gas emissions from agriculture. *Environmental Research Letters*, 8(1):015009, 2013. URL: <http://stacks.iop.org/1748-9326/8/i=1/a=015009>.
- [106] J. Wang, C. Long, J. McNeel, and J. Baumgras. Productivity and cost of manual felling and cable skidding in central appalachian hardwood forests. *Forest Products Journal*, 54(12):45–51, 2004. URL: <http://www.scopus.com/scopus/inward/record.url?eid=2-s2.0-11844274724&partnerID=40&rel=R8.2.0>.
- [107] J.R. Williams and VP Singh. The epic model. *Computer models of watershed hydrology*, pages 909–1000, 1995.
- [108] W. Wint and T. Robinson. *Gridded livestock of the world 2007*. FAO, 2007.
- [109] Liangzhi You and Stanley Wood. An entropy approach to spatial disaggregation of agricultural production. *Agricultural Systems*, 90(1-3):329 – 347, 2006. URL: <http://www.sciencedirect.com/science/article/B6T3W-4JKYWM1-1/2/381253576eb09660fc9860c6c8bb8e1f>.
- [110] Haibo Zhai and Edward S Rubin. Performance and cost of wet and dry cooling systems for pulverized coal power plants with and without carbon capture and storage. *Energy Policy*, 38(10):5653–5660, 2010.
- [111] Chao Zhang, Laura Diaz Anadon, Hongpin Mo, Zhongnan Zhao, and Zhu Liu. Water- carbon trade-off in China’s coal power industry. *Environmental science & technology*, 48(19):11082–11089, 2014.
- [112] OECD and NEA. Uranium 2003: resources, production and demand. Report NEA-05291, OECD/NEA, June 2004. URL: <https://www.oecd-nea.org/ndd/pubs/2004/5291-uranium-2003.pdf>.
- [113] World Bank Group. *World Development Indicators 2012*. World Bank Publications, 2012. ISBN 0-8213-8985-8.