

NOT FOR QUOTATION
WITHOUT PERMISSION
OF THE AUTHOR

MIGRATION AND INTRA-URBAN RESIDENTIAL
MOBILITY IN THE HELSINKI METROPOLITAN
AREA*

Hilkka Summa
Tapani Valkonen
Tuija Martelin**

June 1984
CP-84-30

*Paper prepared for the IIASA Workshop on Dynamics
of Metropolitan Areas, Rotterdam, June 4-8, 1984.

**University of Helsinki, Department of Sociology,
Franzeninkatu 13, 00500 Helsinki 50, Finland.

Collaborative Papers report work which has not been
performed solely at the International Institute for
Applied Systems Analysis and which has received only
limited review. Views or opinions expressed herein
do not necessarily represent those of the Institute,
its National Member Organizations, or other organi-
zations supporting the work.

INTERNATIONAL INSTITUTE FOR APPLIED SYSTEMS ANALYSIS
A-2361 Laxenburg, Austria



FOREWORD

This paper was contributed to IIASA's workshop on "Dynamics of Metropolitan Areas" in Rotterdam, June 1984. It contains an assessment of migration process in the Helsinki region and examines in particular age-dependent mobility of life-cycle type. As such it also provides a background to the study on housing dynamics in the Helsinki region.

Åke E. Andersson
Leader
Regional Issues Project



MIGRATION AND INTRA-URBAN RESIDENTIAL MOBILITY IN THE HELSINKI METROPOLITAN AREA

This paper presents results from a recently completed study (Valkonen, Martelin & Summa, 1984) concerning migration and intra-urban residential mobility in the Helsinki metropolitan area in the year 1981. The study was made mainly for administrative and planning purposes at the initiative of the Helsinki Metropolitan Area Council. So far, the main interest has focused on charting the basic invariances and the effects of population mobility in the area for which reason the work has been mainly empirical. At a later date, the results and the same material may be utilized in a sub-project to the IIASA metropolitan project.

The study was based on material obtained from two registers: the records of the census of 1980, and the continuous population register, which contains information on vital and migratory events. Individual records of the two registers could be combined using the personal identification number as a link, thus allowing the creation of a data set consisting of information on the entire population of the study area and all the moves made by this population in 1981. This type of data permit a reliable description of the properties of movers and the calculation of moving probabilities for different categories of population.

The conceptual and methodological guidelines followed in the

empirical analysis can be briefly summed up in the following four points:

(1) Long-distance migration and mobility within an urban area are two distinct phenomena which should be studied separately and kept conceptually apart. Migration is primarily a process directly connected with developments in the labor market, whereas short-distance mobility is a function of residential considerations and household formation.

(2) A so called two-stage approach to the study of moving was adopted. This means that the analysis was based on the assumption that the probability of making a move and the direction of the move - both in space and between different housing categories - are results of separate decision processes. This view has been both challenged and defended in recent literature on residential mobility (Pickles 1980, 1384; Huff & Clark 1978, 1106; Smith & al. 1979, 4; Speare & al. 1975; Brown & Moore 1970). In the empirical analysis this approach implies that the probabilities of moving are analyzed separately from the directions and the structure of the flows of movers.

(3) Age, family life-cycle phase, and housing conditions are the most central determinants of moving behavior. Thus the age structure of the population and the structure of the housing stock of an urban area or subarea are the most important background factors in the determination of the mobility process of the area.

(4) The intra-urban mobility process consists of distinct sub-processes which should be studied separately. The most important point in this distinction is that mobility due to household formation or dissolution is kept distinct from the

residential mobility of established households.

The area under consideration is the capital region of Finland, consisting of three municipalities: the City of Helsinki, with about half a million inhabitants, and the two neighbouring towns Espoo and Vantaa, with about 150 000 inhabitants each. No more than two decades ago these two neighbouring towns were still predominantly rural areas a few minor agglomerations notwithstanding. The growth of these two cities has been very rapid, and for the most part it is due to a mobility flow from the capital. The three cities currently form a rather tightly interwoven local labor and housing market which the inhabitants normally experience as one urban area (see Figure 1).

The turn-around in mobility flows

A turn-around in the migration flows of metropolitan areas is a well-known phenomenon in most Western countries. In this respect Finland and the Helsinki region are not exceptional. During the 70's the volume of the migration flows to and from the Helsinki region changed radically. The former population gain from outside the region turned to a loss of population after the mid 70's. During the first half of the decade the decline in the migration gain was caused by the spread of housing construction to the near-by municipalities, but later the whole county lost its position as the main destination of migration streams. This turn-around can partly be traced to the weakened economic conditions after the so called oil crisis of the 70's but it was also partly question of a turning point in the urbanization process itself. Though the volume of the

Figure 1. The Helsinki metropolitan area. The number of inhabitants in the cities of Helsinki, Espoo and Vantaa in the years 1960, 1970 and 1980.

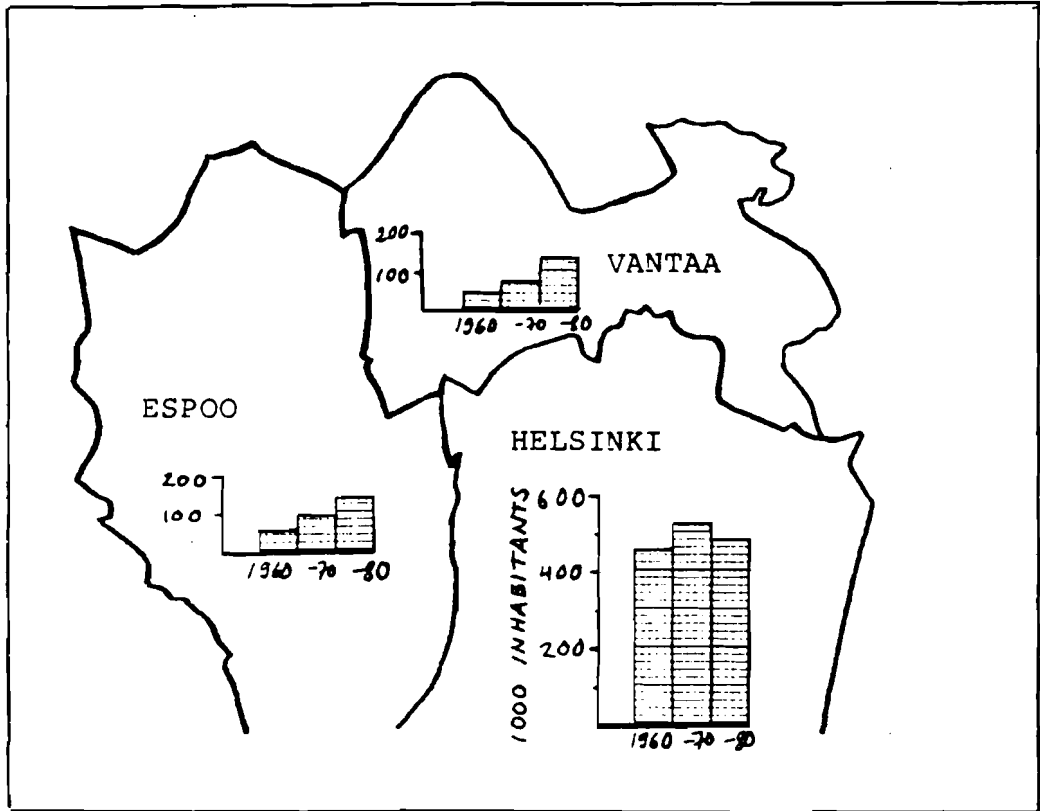
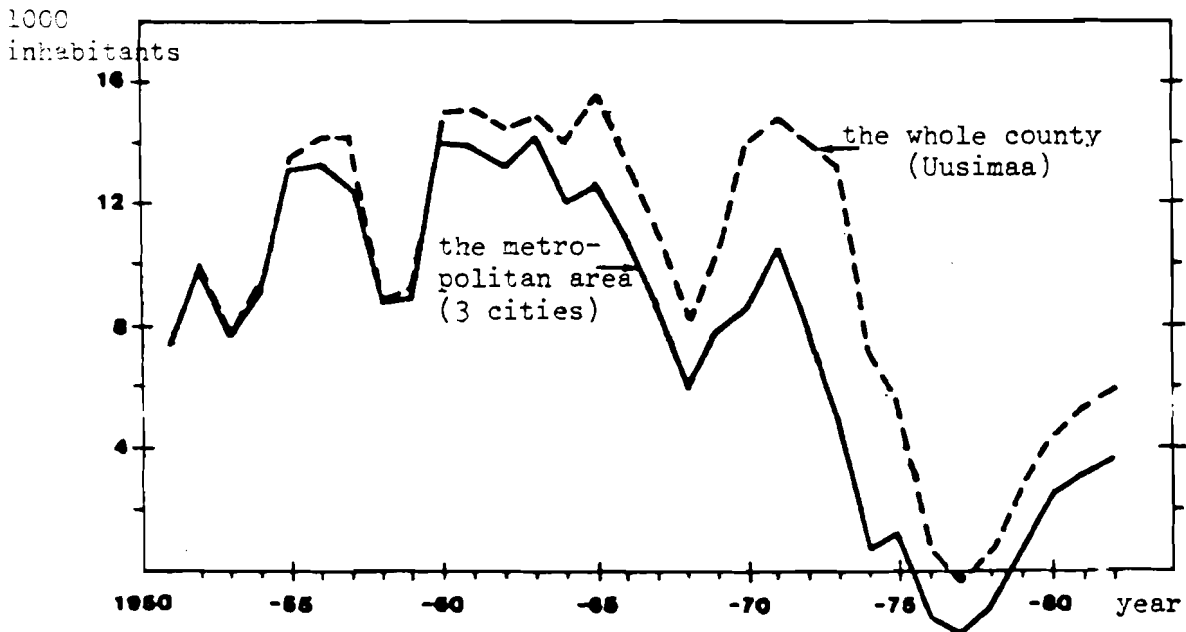

Figure 2. The annual migration gain of the Helsinki metropolitan area and the whole county (Uusimaa) in the years 1951-1982. (International migration included)



migration flow to the Helsinki region has increased somewhat since the slump around 1975-76, the net gain in population to the area has never even approached the level of the 60's and the early 70's (see Figure 2), and it seems unprobable that the migration gain of the region will ever attain its former level again.

During the same period when the migration gain of the whole county turned to a new level, a change also occurred in the volume and direction of the population flows between the three municipalities of the metropolitan area. In the 60's and the early 70's the city of Helsinki lost considerable amounts of its population to the two neighbouring towns, Espoo and Vantaa. During the period from 1960 to 1975 the total loss of population of Helsinki to its neighbours was about 90 000 inhabitants that is to say nearly 20 per cent of its present population. During the same period, more than 60 per cent of the growth of population of these two towns came from Helsinki. But since the mid 70's the flows from Helsinki to its two neighbouring towns have steadily decreased, and at the same time, the flows from these two towns to Helsinki have begun to grow. Nowadays the mobility flows between these three cities are quantitatively much more balanced than they were previously. Thus, nowadays migration is a less significant factor in the development of the amount of population of the three cities of the capital region. The situation is rather similar in the other urban areas in Finland.

The population development of the Helsinki metropolitan area during the recent decades has been periodized as follows (Sarin,

Figure 3. The balance of migration of Helsinki with the rest of the country and with the two neighbouring towns in the years 1960, 1970 and 1980.

1960

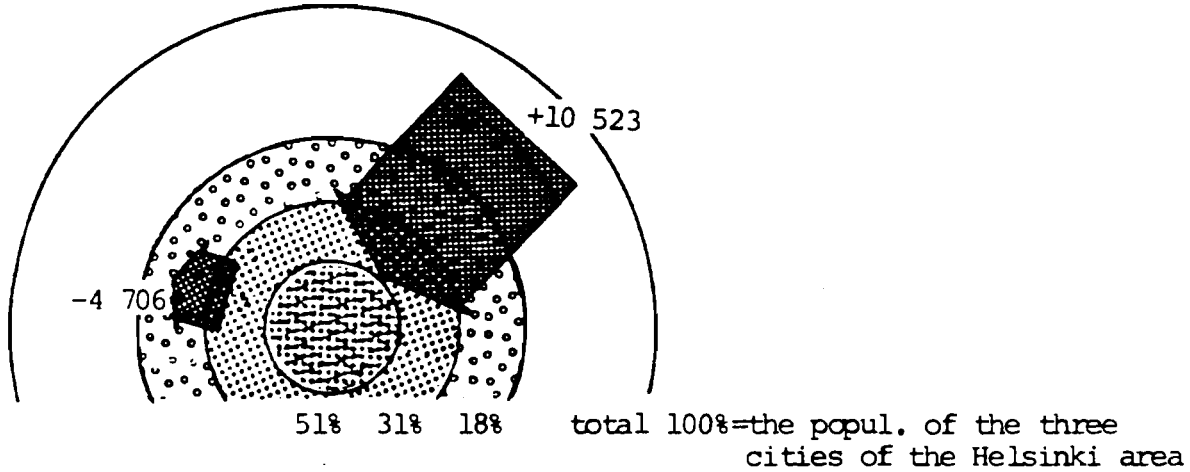

1970

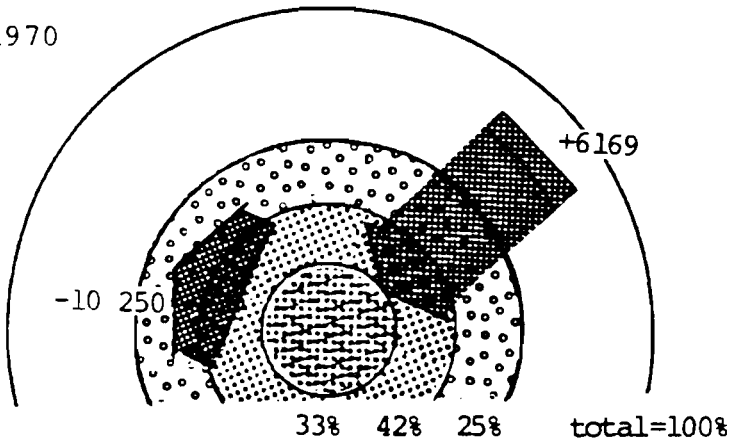

1980

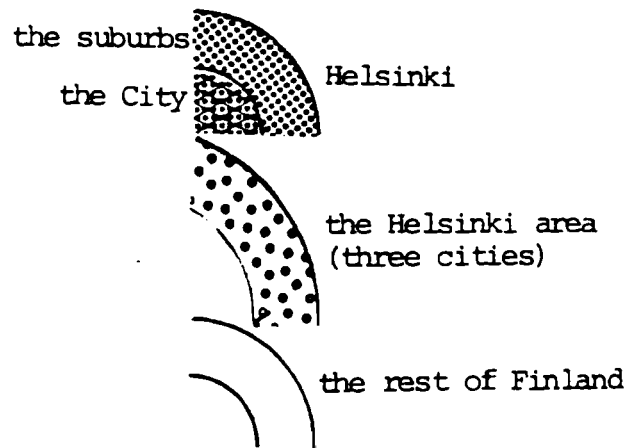
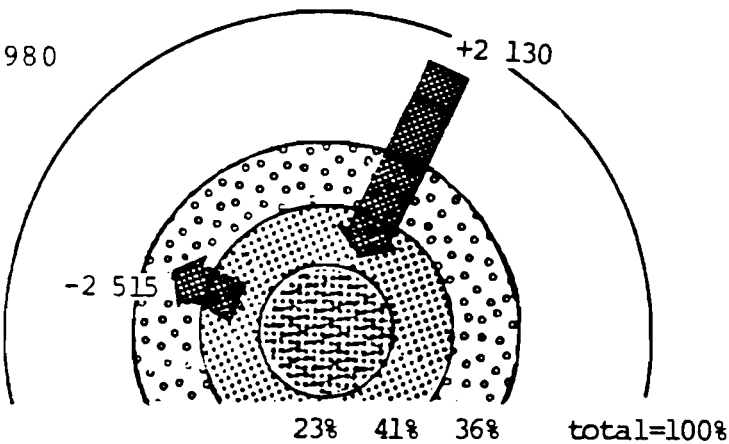

1979, 18-19, figure 3):

(1) 1955-1965: Entry to the capital

The main migration flow comes from the rest of the country to the metropolitan area of Helsinki

(2) 1965-1975: Dispersion to the capital region

The main flow goes from the city of Helsinki to the two neighbouring towns

(3) 1975- : A slowing down of mobility

Population flows between municipalities are no longer a decisive factor in the quantitative population development of the region.

The structure of intra-urban mobility

While very strong fluctuations have occurred in long-distance migration, the amount of residential mobility within the Helsinki metropolitan area has been remarkably stable, with a slight tendency towards increase during the past few years. Unlike long-distance migration, intra-urban mobility seems to be insensitive to economic fluctuations. A rather stable amount of about 100 000 movers annually change residence within the boundaries of the Helsinki area. There are thus annually about 13 intra-urban moves per 100 inhabitants. On the basis of the age-specific mobility rates it can be calculated that the expected number of moves for a person who lives in the area his whole life would be 9 moves. If the moves of the institutional population are excluded, the number of expected life-time moves is 8.4.

From the previous literature on residential mobility it is known that the probability of making an intra-urban move is connected with the life-cycle phase and the housing conditions of the potential movers. The most commonly accepted theoretical view on intra-urban moves sees residential mobility as an adjustment process where housing size, tenure, location, cost or some other aspect of housing conditions is adjusted to the housing needs which change as the life-cycle proceeds. This view as the basic explanation to moving is common to most literature on residential mobility, even though the formulation of the theoretical frame and concepts differ widely depending on whether it is presented in the language of a geographer, an economist or a sociologist.

This view was also accepted as the theoretical starting point for this research. Two subprocesses of the mobility process were, however, distinguished:

- genuine residential mobility of established households
- household formation, where the move is connected with a change in the composition of the household of the mover.

The point in distinguishing these two subprocesses is that as these two types of moves have a very different motivational basis, it is probable that the factors influencing their incidence and direction are also different. Previous research on the motives of intra-urban movers has shown that the motives for moving of established households are normally connected with aspirations concerning some aspect of housing. On the other hand, the movers whose households are being split or who are

forming new households as a result of the move usually present motives concerning other aspects of life than their housing conditions (Summa 1982, 85-87). It is also probable that these two types of moves have rather different macro-level background factors. One could, for example, presume that genuine residential mobility due to residential aspirations is to some extent sensitive to economic fluctuations. This is probably true especially in a housing system dominated by owner occupation, where the availability of financing for home purchasers influences the opportunities of making residential changes. In any type of tenure structure, the availability of attractive vacancies depends on the volume of housing construction. On the other hand, there is less reason to presume that mobility due to household formation should have any close dependence on short-term fluctuations in the housing market. This type of mobility is, for the most part, determined by societal norms and culturally rooted behavioural patterns which change rather slowly.

In the intra-urban mobility of the population of the Helsinki metropolitan area, about one third of the moves of individuals are due to the process of household formation. (The institutional population and the population without a permanent dwelling, as well as their moves, are excluded in this calculation). Thus, about 30 per cent of all the moves involve a change in the household composition. In the rest of the moves, the whole household moves together. Thus the probability of an intra-urban move is about 8 per cent with respect to residential mobility, and a little over 3 per cent with respect to house-

hold formation. The average time between moves is about 13 years if moves due to household formation are not included.

Age, life-cycle phase and housing conditions as determinants of residential mobility

Age is the one single factor according to which the probability of moving varies most clearly. The curve presenting age-specific moving rates (see figure 4) has a two-peak form which shows that young families with little children are the groups most inclined to make intra-urban moves. The probability of moving is highest, on the one hand, for the age groups between 20 and 25, and, on the other hand, for the age group under 5. For those over 30 years, the probability of moving declines steeply. Of the 8.4 life-time moves, almost a half are made during the period between 16 and 34 years of age.

Both the frequency of residential mobility of established households and that of moving due to household formation depend very strongly on age. In household formation this dependence is still stronger than it is in ordinary residential mobility. The differences in moving probabilities between the age groups that move most and those that move least is more than 6-fold for the mobility of established households, and about 18-fold for household formation.

The forms of the age-specific curves for residential mobility and household formation in figure 4 show the differences between the two sub-processes of intra-urban mobility. Moves due to

Figure 4. Age-specific moving probabilities in the Helsinki metropolitan area.

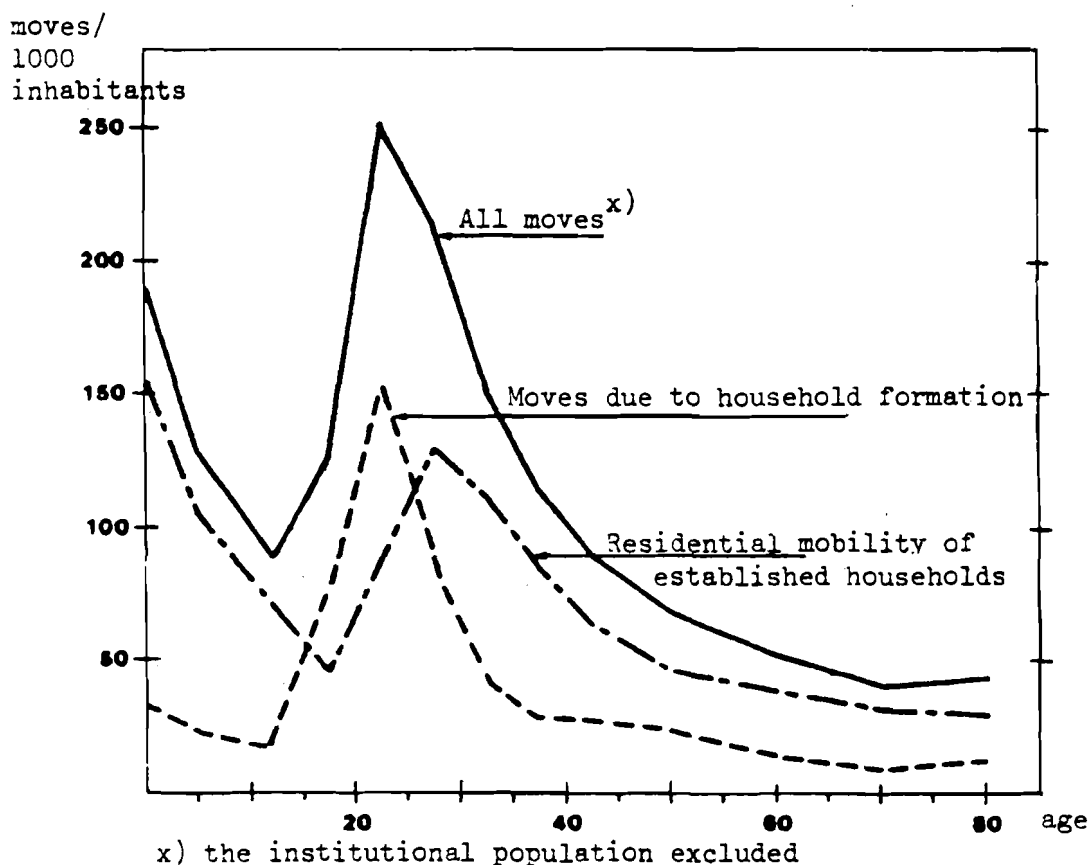

household formation are very rare in other age groups besides those between 15 and 30. Residential mobility with an established household is, on the other hand, most common for people around 30 years and for their children. Moves of this type are still rather common for the age groups between 30 and 40. Thus it can be seen that the high mobility of young people is caused by two separate processes. Firstly, the period of household formation, when "technically unavoidable" moves due to leaving the parental home and marriage occur, falls to the

age groups around 20. Secondly, the period when the need for housing adjustment is greatest, due to a growing family, starts right after the period of family formation. The peak of the probability for this type of moves falls around the age of 30.

The results of an empirical analysis of this type show that intra-urban mobility is a very regular process as to the question of who moves. Thus, the age structure of an urban population will predict rather accurately the number of movers in the area in question. Taking the housing conditions of the potential movers into account will, however complicate the picture to some extent. The interconnections between housing conditions and life-cycle phase as determinants of moving behaviour were analysed by calculating age-specific moving probabilities for people living in different categories of housing (see figures 5 and 6).

The most important factors connected with housing conditions that have an impact on the probability of moving are the tenure form, the size of the dwelling, and the type of building. Previous research has shown that these are the points most often mentioned as motivations for moving. As it was expected, the probability of moving is greatest for those living in rental housing, and it is inversely proportional to the size of the dwelling unit. For people in the most mobile age, the difference between moving probabilities for those living in 1-room dwellings and those living in 6-room dwellings is more than six-fold. The difference between renters and owners is also clear in most age groups, but the impact of the type of building on the moving rate is more important than that of

Figure 5. Age-specific moving probabilities in different dwelling types.

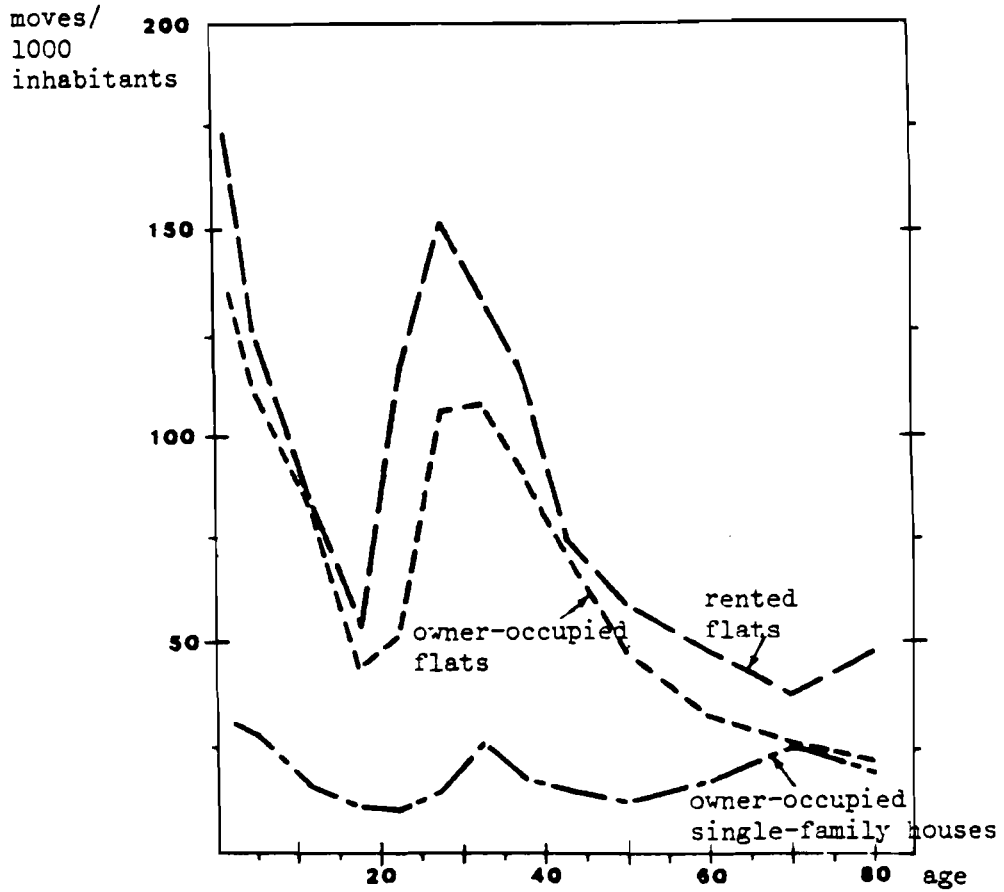
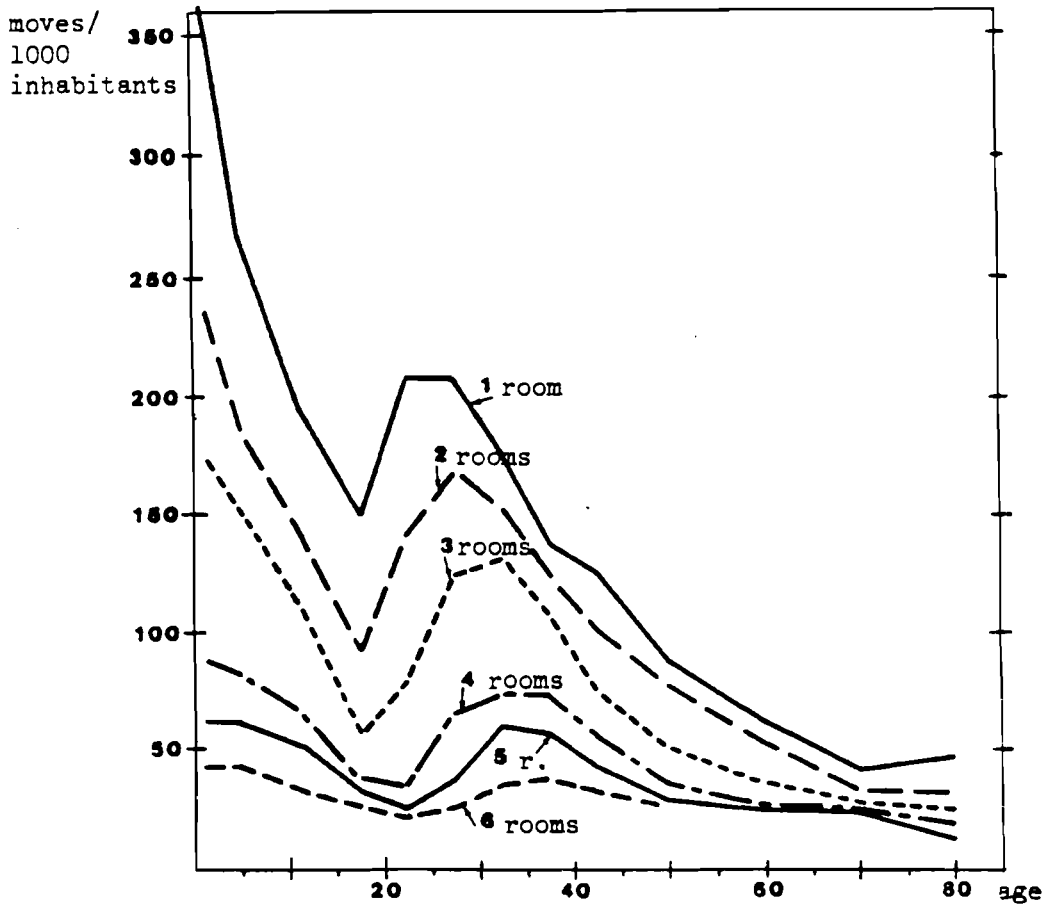

Figure 6. Age-specific moving probabilities in dwellings of different sizes.



tenure in itself. People living in single-family owner-occupied houses are the ones least inclined to move.

The factors connected with the qualities of housing and the characteristics of the potential movers are cumulative in the sense that those categories of housing in which the probability of moving is highest are usually inhabited by people who are in the life-cycle phase in which moving is most common. For example, the residents of small rental units are most often young people. The characteristics of the dwelling do have, however, explanatory power on the probability of moving irrespective of the characteristics of the residents. Figures 5 and 6 show that age as such does not necessarily have a decisive impact on the probability of moving. Rather, it is the combination of age and housing conditions that determines moving behavior.

The moving behaviour of people living in owner-occupied single-family houses is very different from that of residents in any other housing category. In this type of housing, the curve of age-specific moving probabilities assumes an exceptional form. Moving from an owner-occupied house is very rare, and it occurs almost solely in connection with a split of a household. The explanation for this is that the owner-occupied single-family house is typically the end point of the housing career of Finnish urbanists. Also, in all large (6 or more rooms) dwellings the moving rate is very low for all age groups, and, in this case as well, the curve on age-specific moving probabilities assumes an exceptional form. Thus, the families which have attained a large dwelling or their own house at a very early stage of their life-cycle, or which have perhaps

started their housing career in this type of housing, do not follow the mobility pattern which is characteristic of those who have started their housing career in a smaller flat.

The directions and the structure of mobility flows

Even though mobility no longer has a decisive effect on the amount of population in the sub-areas of the region, it still contributes to changes in the structure of population in different parts of the area. As the mobility flows are differentiated with respect to the age, socio-economic and income distributions of the movers, these effects tend to be cumulative. In this respect, intra-urban mobility is a most important background factor for town planning and the planning of municipal services. It may have dramatic effects on the need for schools, nurseries and health services. It also has an indirect effect on the development of traffic flows and on the location of commercial services within the urban area. Besides all this, it is an important background factor for the development of the financial position of the municipalities of the area, and it tends to create a competition for "good" movers between them.

In recent discussions the high level of residential mobility has also been seen as one of the pathologies of urban life. It has been pointed out that a high level of mobility may be harmful to the social stability of residential areas. A high level of mobility may be seen both as a cause and as an indicator of social problems in a residential area. Besides this, the cumulative effects of socially and economically differentiated

mobility flows tend to be a factor enforcing the social segregation between the residential areas of the region. This can also be rather clearly seen in the mobility of the Helsinki metropolitan area.

The most commonly known empirical generalizations concerning the directions of intra-urban moves are that most moves tend to be centrifugal, that they tend to be rather short and stay in the sector of origin, and that they are directed upwards in the hierarchy between housing categories. These tendencies are also present in the mobility of the Helsinki area. The centrifugal tendency has, however, diminished somewhat because moves from the ring towards the center have recently increased to some extent.

For the analysis of the directions and the structure of the mobility flows, the metropolitan area was divided in two sub-areas: the City, which consists of the tightly built inner urban structure of Helsinki, and the ring, which consists of the suburbs of Helsinki along with the two neighbouring towns.

The net result of intra-urban flows is that the City loses 1-2 per cent of its population annually to the ring, while the ring adds about 0.5 per cent to its population annually. Yet the total population loss of the inner parts of the area is negligible nowadays in spite of the ongoing centrifugal flow, because the City serves as a reception area for migration from other parts of the country.

Apart from the general tendencies and the net figures on the directions of the mobility flows, it is important to focus on

the differences in the structure of the flows going in different directions. Certain moving directions are more typical of some population categories than of others. These differences between mobility flows are, for the most part, a result of the differences in the housing stock and construction of the various sub-areas. Theoretically, and according to previous literature, it was presumed that the centrifugal and centripetal flows would be strongly differentiated as to the age and life-cycle phase of the movers. These assumptions were largely confirmed by the empirical analysis. The moves of families in the child-bearing phase are, for the most part, directed outwards from the City. Thus the population loss of the City is greatest in the age groups of young families and their children. The City loses population in all other age groups except those between 16 and 24 years. These are the age groups of grown-up children, who move away from their parents' home. This type of moves are very often directed towards the center. (See figure 7.)

Figure 7. The net effects of intra-urban mobility on the age structure of the City. Net gain/loss of population per 1000 inhabitants in each age group.

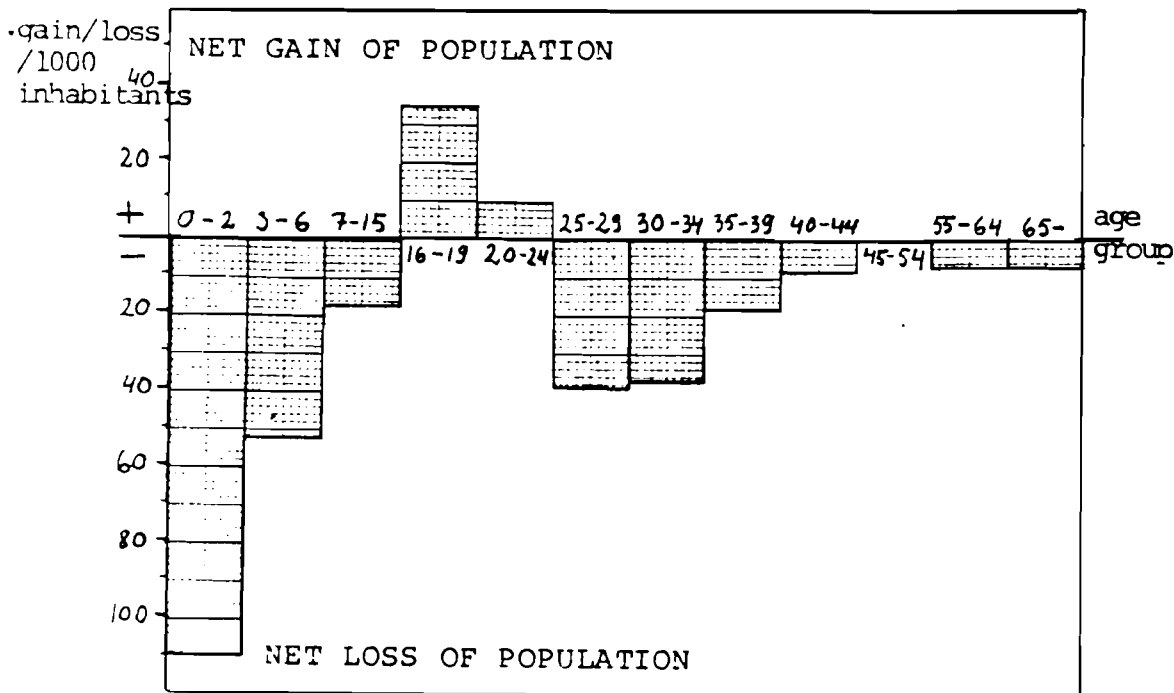

Apart from the differentiation between the centrifugal and centripetal flows, a sectoral differentiation according to the income level as well as the life-cycle phase of the movers can be observed. For example, the net population gain which the two neighbouring towns of Helsinki obtain as a result of the centrifugal movement are very clearly differentiated with respect to the incomes of the movers. The share of high-income groups is greater in the income distribution of the movers to the western neighbouring town (Espoo) than in the distribution of the movers to the northern neighbouring town (Vantaa). The movers to Vantaa also tend to be younger than those who have the western part of the ring as their destination. Thus the net population gain of Vantaa consists for the most part of single and childless people, whereas that of Espoo consists for the most part of established families in the child-bearing or child-rearing phase. For the most part the sectoral differentiation of the intra-urban flows reflect the differences in the housing stock that the two neighbouring towns offer for the movers.

The centrifugal and centripetal flows are also differentiated with respect to the income distributions of the movers. In the outward flow the movers have higher incomes than do those in the inward flow. This results in a net economic loss for the city of Helsinki, and in a gain for its two neighbouring towns. Due to the sectoral differentiation in income distributions, the gain of the western neighbouring town is, however, 2.5-fold compared to that of the northern neighbouring town. As the municipalities are well aware of this tendency, they compete

for the more well-off movers by planning and encouraging the building of such residential areas that attract families with higher incomes. This is a problem, because it is likely to hinder the improvement of the housing situation of the low-income groups.

The implications of residential mobility to various residential areas

In order to perform an analysis of the area level invariances in residential mobility, the metropolitan area was divided in 141 residential areas, and mobility rates as well as various indicators of the type and implications of mobility in these areas were calculated. The interdependencies between the type of mobility and the characteristics of the area were also examined.

The variations in mobility rates between residential areas are great, the relative yearly turn-over of inhabitants being only about 3 per cent in some areas, and as high as 25 per cent in a few special cases. These variations cannot, however, be interpreted as indicators of the "goodness" or the popularity of the different areas because they are, for the most part, explained by the differences in population structure and housing conditions. The mobility rate is highest in areas where the population is young and the proportion of crowded dwellings is high. Thus, the differences in the structure of mobility and its net results in the different areas are more interesting than are the differences in the annual turn-over itself.

Rather often it is assumed, that certain general characteristics of a residential area such as its reputation would determine the relative amount of moves from the area or the type of movers it attracts. Assumptions of this type could not, however, be verified in an empirical analysis concerning residential areas of the Helsinki area.

Variations in the mobility rate, in the directions of moves, and in the results of mobility have high correlations with indicators of the characteristics of the housing stock and the population in these areas. Thus these variations seem for the most part to reflect the individual level determinants of residential mobility.

Firstly there is, of course, a great difference between the areas where new construction has occurred and those where no new homes have been built. Areas in which no new residential construction occurs lose an average of 1.4 per cent of their population annually. The areas with new construction naturally have the greatest mobility gains, the average net gain being 1.9 persons per each new residential unit.

Secondly there is a striking difference between areas with a housing stock dominated by multi-storey buildings and those with predominantly single-family or terraced housing. The latter areas are usually rather stable and have low mobility rates, whereas the areas with most of their housing stock in multi-storey blocks normally have rather high mobility rates. Of course this reflects the individual level connection between the type of building and the probability of moving, the single-

family house being the typical end point of a housing career. But there are also great differences in the structure and net results of mobility between these two types of areas. The high-rise areas normally suffer mobility losses, whereas the small house areas quite often show slight mobility gains even in the cases where no new construction has occurred. This is probably due to the fact that the single family house is very often the destination of the movers with a large family. Another difference between high-rise ^{areas/} and areas dominated by single-family houses is that in the latter, mobility increases the proportion of children under school age, whereas in the high-rise areas it diminishes the share of this age group in the population.

In the small house areas mobility also raises the proportion of school aged children, but not to the same extent as that of younger children. This is due to the fact that families with children between 7 and 15 move within their original residential area more often than do other family types. This phenomenon supports and complements the observation made in the individual level analysis: the presence of school aged children decreases the family's inclination to move, and if a move occurs, its probability of being a very short one is greater than on average.

There is also a difference between high-rise and small house areas with respect to the implications of mobility to the social structure and the income distribution of the area. In the high-rise areas the share of high-income groups decreases slightly as a result of residential mobility, whereas in the small house areas there either is no change in their share

at all, or it increases only slightly. The changes tend to be cumulative so that an increase in the share of high-income groups is slightly greater in the areas where their share was already large during the previous year. On the average, the areas dominated by single-family houses have a higher share of both high-income families and of professionals and other upper-level employees than do the high-rise areas, and also this difference tends to increase as a result of residential mobility. Mobility thus tends to strengthen the social segregation between residential areas.

A third characteristic of the residential areas which has a very clear connection with the structure of residential mobility is the share of small residential units in the housing stock of the area. This characteristic of the housing stock has implications especially for the mobility rate and directions of families with children. The mobility rate of young families in the child-bearing phase has a high correlation with the share of small dwellings in the housing stock, and it shows how decisive the role of housing conditions and especially of floor space is in explaining the variances in areal mobility rates. Thus, areas with a relatively old housing stock with predominantly small (1-2 room) residential units suffer an exceptionally high loss of population in the age groups of young families and their children.

In order to sum up the variations in mobility between residential areas, some experiments with cluster analysis were made. The groupings of the 141 areas were made on the basis of variables depicting the type and implications of mobility. As a result,

five area types could be distinguished, each characterized by certain special features in its housing stock and population structure as well as in its rate and structure of mobility.

Table 1 and 2 present some indicators depicting both the population structure and the housing stock of the five area types as well as the net results of residential mobility on them. Figure 8 presents the location of the various area types in the urban structure.

The first type consists, for the most part, of the inner city areas of Helsinki. Characteristic of these is the exceptionally high rate of mobility for families with children under school age. The share of moves staying within the area of origin is small. These areas suffer population losses as a result of residential mobility, and the most characteristic feature in this loss is the diminishing proportion of children under 7 years of age. The housing stock in these areas is rather old, built mainly before World War II, and characteristic to it is the large proportion of small dwellings.

The second type could be called first generation suburbs. In these areas the mobility rate is rather low, and an exceptionally large proportion of it stays within the boundaries of the same area. The housing stock in these areas consists, for the most part, of blocks of flats built during the 50's and the 60's. These areas are, for the most part, located in the zone around the inner city. As to the impact of mobility, these areas seem to be rather stable, the most important results being a slight increase in the share of persons over 65 and a slight decrease in the share of high-income groups.

The third type consists of areas located mainly in the ring. These could be characterized as the second generation suburbs. Their housing stock consists mainly of blocks of flats, built during the 70's and with quite a lot of new construction still in the 80's. Characteristic to the population structure in these areas is the large share of children under school age. The mobility rate is high, but quite a large proportion of it stays within the same area. The net result of residential mobility is to slightly diminish the share of children as well as that of high-income families, professionals and other upper-level employees.

The fourth type consists of areas with a housing stock dominated by single-family or terraced housing, and it has been labelled the stable small house areas. These areas are mainly located in the ring, and they show a rather low mobility rate, but also the share of moves staying within the area of origin is low. The share of the high-income group is large in these areas, and it still rises as a result of residential mobility. Also an increasing proportion of children and upper-level employees is characteristic to this area type.

The fifth type can be labelled the renewing small house areas. As to the structure of the housing stock, it resembles the fourth type with the exception of a rather intensive new construction of single-family or terraced housing. Thus, areas of this type are the focus of considerable gains in mobility, and these especially increase the share of young age groups in their population. Characteristic of their population is also

Table 1. Some characteristics of the five area types

Variable	The inner city areas	The 1st generation suburbs	The 2nd generation suburbs	The stable small house areas	The renewing small house areas
Percentage of dwellings built in the 70's	13	24	59	30	30
Percentage of dwellings built before before World War II	46	9	2	12	16
Percentage of 1-2 room dwellings	54	34	28	19	23
Percentage of dwellings in single-family houses	6	14	16	70	54
Percentage of the age group 0-6	7	8	12	9	9
Percentage of the age group 64+	17	12	5	9	10
Percentage of the high income groups	8	9	9	13	14
Percentage of upper-level employees	18	18	22	19	22
Number of dwellings built in 1981	17	32	99	33	84

Table 2. Mobility and its net results on the five area types

Variables	The inner city areas	The 1st generation suburbs	The 2nd generation suburbs	The stable small house areas	The renewing small house areas
The rate of mobility, moves/1000 families	102	82	107	60	70
The rate of mobility of families with children	205	153	149	80	101
Moves staying within the area of origin ¹⁾	76	116	137	56	77
Net gain/loss of population per 1000 inhabitants	-14	+2	+13	+9	+61
Index of the net effects of mobility					
- age group 0-6	93	100	100	104	108
- age group 7-15	100	99	99	101	103
- the high income group	101	98	97	101	98
- upper level employees	99	99	99	103	103

1) Established families only.

2) An index showing the ratio (multiplied by 100) of the actual number of moves to the expected number of moves staying within the area, calculated on the basis of the size of the housing stock and the amount of new construction.

Figure 8. A grouping of the residential areas according to the rate and structure of mobility. Cluster analysis.

Kartta VHI 8 A)

ASUINALUEIDEN RYHMITYS MUUTTOLIIKEPROFIILIN MUKAAN

(Ei merkitä Eläköikäisiä tyyppiä)

- Lapsikatolueet
- Vakiintuneet muuttoliikkeen alueet
- ▼ Uudet kerrostalolueet
- Vakiintuneet pientalolueet
- Uudistuvat pientalolueet

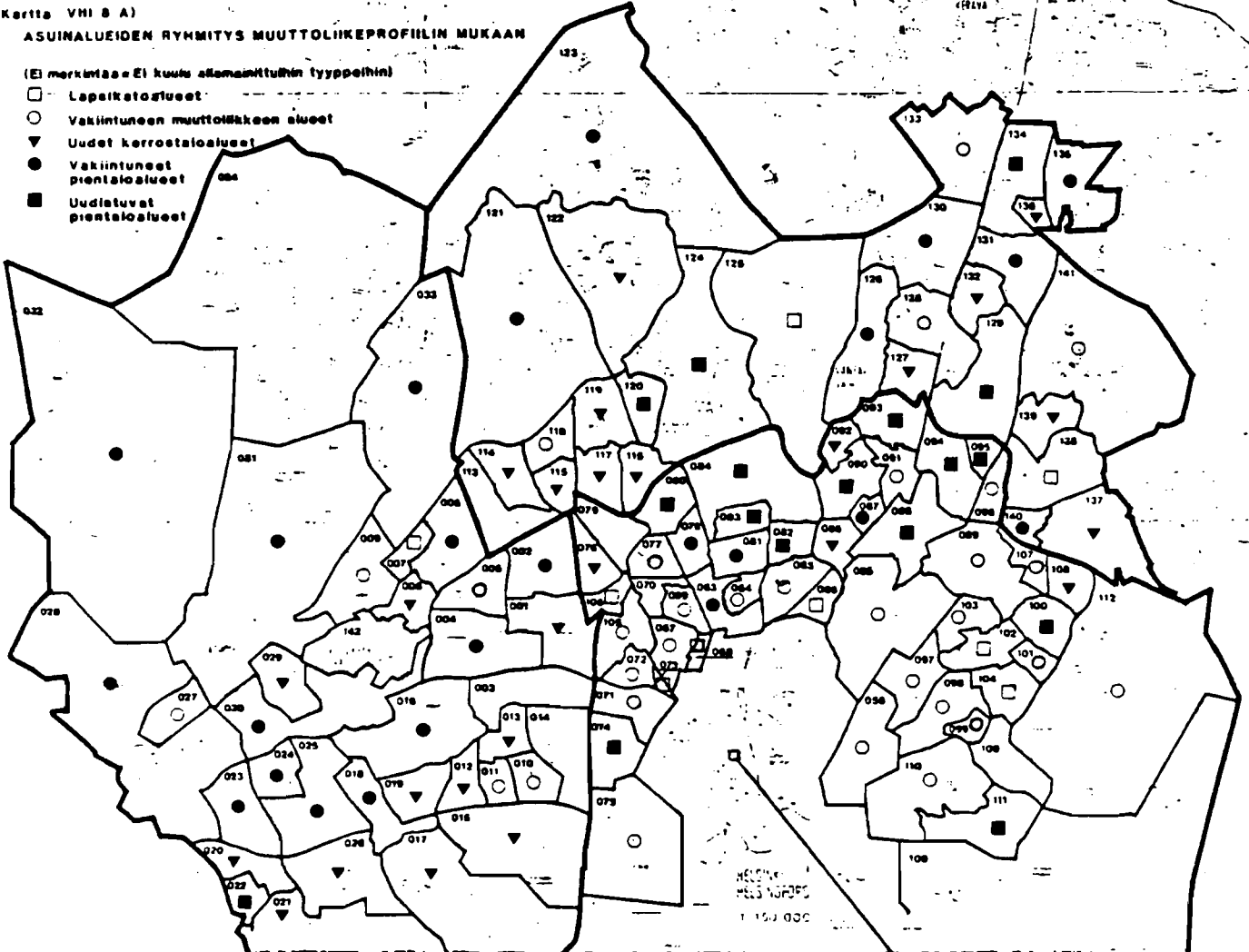

- The inner city areas
- The 1st generation suburbs
- ▼ The 2nd generation suburbs
- The stable low-rise areas
- The renewing low-rise areas

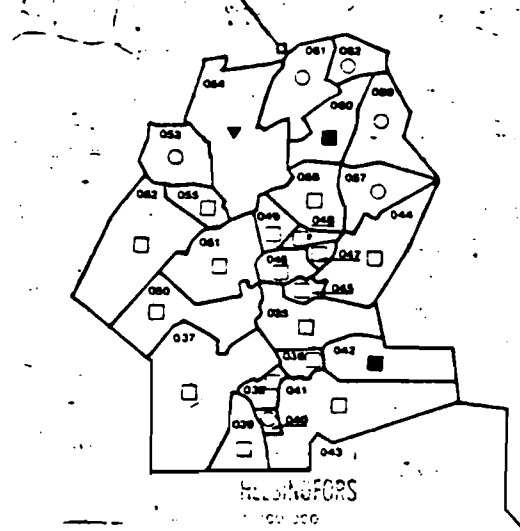

the rather large and increasing share of high-income groups. Some of these areas are typical gentrification areas, where the older and poorer population is giving way to new construction and young wealthier families. The most typical location of this area type is in the inner ring area, and thus it is most common in the suburbs of Helsinki.

Concluding comments

The most consistent observation throughout the empirical analysis, well-known from the previous literature, has been the regularity of the frequency, type, and directions of the moves as to the age, life-cycle phase, and the housing conditions of the movers. Age is one of the most important factors distinguishing the mobile and the stable categories of population. Thus, changes in the age structure of the urban population will have inevitable consequences for the mobility process in the area. In the Helsinki area, the age structure of the population is slowly growing older as the share of children is diminishing and the post-war baby-boom birth cohorts are approaching their 40's. The share of the most mobile age groups is diminishing in the population of the area. This will, other things equal, cause a slight decrease in the amount of residential mobility. The anticipated slight growth of the population of the area will, however, compensate for the decrease so that the average number of intra-urban movers will probably be rather stable in the near future.

What is more important, the change in the age structure of the

population will bring about a change in the age structure of the movers as well, and this, in turn, will have implications to the type and structure of demand on the housing markets. As the share of young families with little children diminishes in the population, it will also diminish in the movers. If the age specific moving probabilities stay unaltered, the number of movers in the age group 20-29 years will diminish by about 18 per cent, while that of movers in the age group 40-64 years will grow over 40 per cent until the year 1996 (see table 3). Thus, the demand for the types of housing characteristic of the early life-cycle stages will diminish, while the demand for housing characteristic to middle-aged families will increase. In the 70's and in the 80's the dominant groups on the housing markets have been young people who are forming their first household or who are seeking more space for their growing family. As the share of these groups diminishes in the 90's, the demand in the housing market will probably turn more to large, high-quality dwellings and, especially to single-family and terraced housing. This tendency may further strengthen the segregative effects of the residential mobility process, since the dominant group on the housing market will be in a position where more attention can be focused to the quality of housing and the environment, and not solely to the amount of living space.

During the past three decades a vast international literature has grown on residential mobility in the urban areas. Since the 50's - and to some extent already in the 20's and the 30's - the subject has been studied by sociologists, economists and,

Table 3. A projection of the number of movers in various age groups in the year 1996, assuming that the age-specific moving probabilities will be the same as in 1981. Residential mobility of established households only.

Age group	Number of movers		Percentage of change
	1981 (actual)	1996 (projected)	
0-6	7700	6900	-10
7-19	7400	6900	-7
20-29	13400	11000	-18
30-39	14000	12800	-9
40-64	9100	13000	+43
65-	2300	2800	+22
Total	53900	53400	-1

especially in the 70's by geographers. This literature is a rather interesting example of the development of inter-disciplinarity and the accumulation of scientific knowledge. At this point it seems that a commonly accepted view exists about how the probability of an intra-urban move is formed, and the manner in which the mobility flows tend to be directed.

The view of residential mobility as an adjustment process where the housing situation is adjusted to changing housing needs as the life-cycle proceeds - the view presented as early as in the 50's by Rossi - can hardly be questioned. There are, however, certain aspects of the mobility process which this view does not cover and which have not yet been widely discussed. Most of the literature on residential mobility presents different types of cross-section analyses of the incidence and directions

of moves in a certain urban situation, and only very few long-term examinations of variations in the mobility process have been made. Thus, the past and the future of the mobility process in different urban environments, and its connections to variations in cultural and institutional settings have received rather little attention in the scientific literature. This type of analysis could, however, bring interesting new viewpoints to the understanding of urban mobility.

For example, from the very few sources which provide any information on mobility in the Helsinki of the turn of the century, it can be concluded, that short-distance moves were very common at that time too. But it can also be concluded that, in spite of the lively mobility, a residential adjustment process did not exist in the same sense as it does today. The moves were, for the most part, very short, very often forced or due to too expensive housing costs or some other necessity, and, what is most important, they obviously did not have a consistent ameliorative effect on the housing conditions of the movers. Thus, the phenomenon often labelled as the housing career seems to be a rather recent product of a high material standard of living and a specific institutional frame and functioning of the housing markets. Home ownership and the personal dwelling as a form of accumulation of wealth are probably important factors in the development of the residential adjustment process.

These are, of course, only preliminary considerations. As a hypothesis for further research, it could be presented that

residential adjustment is a culturally and institutionally specific process which takes similar forms in different urban environments as far as the workings of the housing market and the cultural codes concerned with housing and its meanings are similar. Thus the tendencies in the future development of the urban mobility processes, as well as their implications for the long-term development of the urban environments, can best be understood by analysing the connections of the variations in the forms and frequency of residential mobility with the variations in the institutional frame of the housing market, in housing policy, and in the various official and unofficial norm systems concerning housing.

REFERENCES

- Brown, L.A. & Moore, E.G.: The intra-urban migration process: a perspective. *Geografiska annaler* 52 B(1970):1-13.
- Huff, J.O. & Clark, W.A.V.: Cumulative stress and cumulative inertia: a behavioral model of the decision to move. *Environment and Planning A* 10(1978):1101-1119.
- Pickles, A.: Models of movement: a review of alternative methods. *Environment and Planning A* 12(1980):1383-1404.
- Rossi, P.H.: *Why Families Move*. Glencoe, Ill. 1955.
- Sarin, M.: Helsingin muuttoliikkeen piirteitä, syitä ja näkymiä. (Helsingfors flyttningsrörelse - kännetecknande drag, orsaker samt framtidsperspektiv.) Helsingin kaupunki, Tilastokeskus. Neljännesvuosikatsaus 1979:3.
- Smith, T.R. & Clark, W.A.V., Huff, J.O. & Shapiro, P.: A Decision-Making and Search Model for Intra-urban Migration. *Geographical Analysis* 11(1979):1-22.
- Speare, A., Goldstein, S. & Frey, W.: *Residential Mobility, Migration and Metropolitan Change*. Cambridge, Mass. 1975.
- Summa, H.: Kaupunkien sisäinen muuttoliike muuttotyypeittäin. *Yhdyskuntasuunnittelun jatkokoulutuskeskus B 40*. Otaniemi 1982.
- Valkonen, T., Martelin, T., & Summa, H.: Muuttoliike ja asunonvaihdot pääkaupunkiseudulla. Pääkaupunkiseudun julkaisusarja B 1984:1. (Om flyttningen och bostadsbyten i huvudstadsregionen. Sammandrag på svenska).