

WORKING PAPER

MULTI-STATE ANALYSIS OF FAMILY DYNAMICS IN AUSTRIA: SCENARIOS TO THE YEAR 2030

*Wolfgang Lutz
Sergei Scherbov*

January 1989
WP-89-05

**MULTI-STATE ANALYSIS OF FAMILY DYNAMICS
IN AUSTRIA: SCENARIOS TO THE YEAR 2030**

*Wolfgang Lutz
Sergei Scherbov*

January 1989
WP-89-05

This paper was presented at the Workshop on Multistate Demography: Measurement, Analysis, Forecasting in Zeist, The Netherlands, Oct. 31–Nov. 4, 1988. The work was in part supported by grant No. P6006S of the Austrian Science Foundation.

Working Papers are interim reports on work of the International Institute for Applied Systems Analysis and have received only limited review. Views or opinions expressed herein do not necessarily represent those of the Institute or of its National Member Organizations.

INTERNATIONAL INSTITUTE FOR APPLIED SYSTEMS ANALYSIS
A-2361 Laxenburg, Austria

Foreword

The methods of multi-state demography can generally be applied to any process where transitions between states occur in dependence on age and one is ready to make the Markovian assumption that the transition probability depends only on the present state and on age. It turns out that this methodology fits quite well to the complex field of family demography and helps to avoid several pitfalls of other models such as the traditional family lifecycle approach. Aside from the analysis part the multi-state model can also be used to project the future distribution over states under different scenarios. This was done using IIASA's interactive DIALOG program for the case of Austria.

Wolfgang Lutz
Deputy Leader
Population Program

Contents

	<i>Page</i>
INTRODUCTION.....	1
DATA.....	3
The Model.....	4
RESULTS FOR 1981-1986.....	5
SCENARIOS FOR FUTURE FAMILY STATUS DISTRIBUTIONS.....	13
CONCLUSION.....	21
REFERENCES.....	23

MULTI-STATE ANALYSIS OF FAMILY DYNAMICS IN AUSTRIA: SCENARIOS TO THE YEAR 2030

Wolfgang Lutz and Sergei Scherbov

INTRODUCTION

In Austria—like in most other European countries—the size and structure of families has undergone dramatic changes during the last century. Fertility declined from an average of more than four children per woman to less than two. Proportions married had been increasing during the first half of the century, peaking in the 1960s, but started to fall since then; at the same time divorce rates have risen sharply. The “normal” nuclear family which has—in popular perceptions, at least—dominated our societies during this century, seems to be losing its universal significance, after having reached its peak during the time of the post war baby boom.

As in the change from the traditional patterns of extended families and high proportions unmarried to the modern pattern of nuclear families, the processes of this recent change have not been uniform throughout all European countries. In Austria, for instance, illegitimacy has been traditionally very high but still the desire to marry (even after some premarital births) seems to be universal. Simultaneously divorce rates are increasing. In Sweden, on the other hand, not being married and living together even with children seems to have become almost the normal case. But divorce rates in Sweden seem to have leveled off.

What can the demographic analysis of the family contribute to the understanding of these phenomena? Demographers often treat the phenomena of nuptiality, fertility and mortality separately. Since Lotka's developments in stable population theory, with the exception of recent generalisations, there has been no comprehensive model showing the interdependencies of these demographic phenomena. The traditional family lifecycle approach (best exemplified by Glick, 1947) attempted to provide a framework for this kind of analysis but suffered from some serious drawbacks. This traditional approach postulated a predefined sequence of events (marriage, first birth, last birth, death of first spouse, death of second spouse) which leaves out all individuals who do not follow the prescribed pattern. Hence, in the presence of increasing illegitimacy and divorce the traditional

model has become obsolete from an empirical point of view.

But the usual family lifecycle approach has also a more methodological problem in calculating the mean sojourn times in a status: simply taking the difference between the mean ages at entrance to and exit from the state is misleading and often wrong, if not all the persons who enter the state also leave it, because then two different groups are compared. By using a life table approach instead of the difference between mean ages this problem can be avoided.

Recent attempts to improve upon the family life cycle concept (Glick 1977, Norton 1983)—for instance by allowing for many different types of family cycles—do not fully overcome these problems. The literature criticising the traditional family life cycle approach is abundant (e.g. Elder 1977, Nock 1979, Höhn 1982) but real alternatives are rare.

Our model which has first been defined in this form by Lutz and Feichtinger 1985 (see also Lutz and Wolf 1987; Aufhauser and Lutz 1987) tries to avoid the pitfalls of the traditional lifecycle analysis by using a multi-state life table approach with the state space defined by a cross-classification of marital status and parity. Hence a first important step is to progress from family lifecycle analysis to individual lifecycle analysis, where the unit of analysis is the individual and not the family, an aggregate entity consisting of more than one individual. Marital status and the number of children become attributes associated with an individual instead of features of the family. This brings the great number of possible family structures down to a common standard. But there still remain three perspectives from which to look at the phenomenon: from the mother's, the father's and the children's. For simplicity analysis is usually restricted to mothers; this will also be done in our study.

The methodology and applications of multi-state demography have seen rapid growth during the late 1970s (Rogers, 1975; Schoen, 1975; Keyfitz, 1980; Land and Rogers, 1982; and many others). Some studies employing the multi-state methodology have focused on marital status transitions. Schoen and Nelson (1974), Krishnamoorthy (1979), Espenshade and Braun (1982), and Espenshade (1983) calculated marital status life tables for the United States. By Schoen and Urton (1979) this was done for Sweden, and by Willekens et al. (1982) for Belgium. Suchindran et al. (1977) analyzed fertility by increment-decrement life tables.

While the studies cited above take only a partial view on the family, examining either marriage or reproduction, Kuijsten (1986) has also defined a model that cross-classifies marital status and parity.

DATA

In this study we use data from the special program that was part of the micro-census of June 1986 conducted by the Austrian Central Statistical Office, a 1% sample of the Austrian population. For all women between ages 16 and 60 that were included in the micro-census, birth and marital status histories were recorded. After removing some apparent inconsistencies from the data by either adjusting them or removing the cases from the data, complete records for 14,500 women were given that should be representative for Austria.¹

For this paper all transitions from one marital or parity status to another over the five years preceding the survey were considered. Hence the data pertain to the period May 1981 to May 1986. The procedure to reconstruct the transition rates from the given histories was the following: starting from the given distribution of the women over the family status at the time of the survey one goes back in time month by month, measures the transition taking place during that month and at the same time adjusts the distribution of the risk population according to the changes that were measured over the month. Because of the short length of the interval considered (one month) double transitions could be largely avoided. Multiple births were counted as simple births, but in the adjustment of the status distribution the number of children born was considered.

This procedure results in 60 sets of age-specific monthly transition rates which finally were aggregated by adding up numerators (numbers of transitions per month) and denominators (person-months of exposure) separately. This procedure assumes independence of the transitions in one month from those in previous months at every age and family status. The resulting average monthly transition rate was transformed into an annual rate by multiplication with 12. The patterns of the age-specific transition rates from one family status into another cannot be described in detail here, but is discussed at length in Aufhauser and Lutz (1987).

¹See Aufhauser and Lutz (1987) for more detail concerning the data of this survey.

The Model

The state space of the multi-state model defined here consists of 12 states resulting from a cross-classification of parity and marital status. The number of parity categories considered varies for the different marital statuses according to the frequency and substantive importance of the parity categories for interpretation. For unmarried women we consider only two categories (childless and with one or more children) whereas for married women four categories (0 to 3+ children) are considered. For widowed and divorced women three parity categories (0 to 2+ children) are defined. With respect to parity the model is hierarchical, i.e. no movement from higher to lower parities is possible. For marital status only the the unmarried state cannot be reentered once a woman had left; the other three states may be entered and left any number of times.

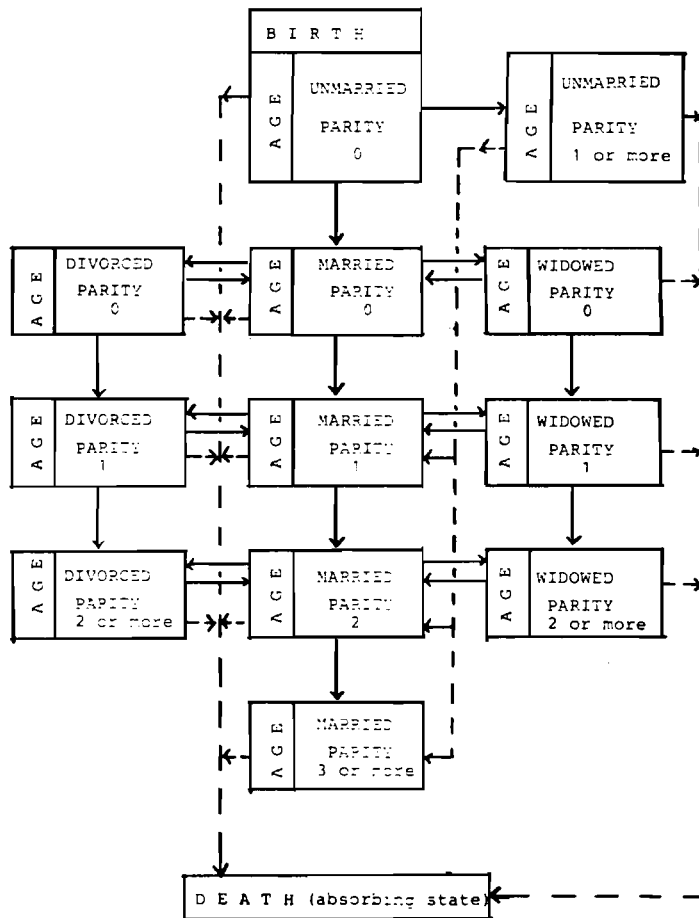

Chart 1. A multi-state model considering parity and marital status.

Chart 1 illustrates the transition probabilities considered in this study. Death is the absorbing state that can be reached from any status at any age. Since we do not have information on age-specific mortality specific for parity and marital status, we assume that the age-specific mortality pattern of the Austrian life table of 1981/82 pertains for all statuses.

RESULTS FOR 1981-1986

The multi-state life table may be used for the analysis of transition patterns at one given period in time (i.e. conditional and chained transition probabilities, mean sojourn times in various states depending on the age at entry). It may also be used to project the distribution of the population over the states under given or assumed sets of transition rates. In this study we will use both approaches. First we will look at the pattern of family dynamics as implied by the 1981-1985 data in Austria. Next we will specify several scenarios of possible future change and project the family-status distributions in Austria to the year 2030.

The possible numerical results that can be drawn from a 12-state multidimensional model are extremely extensive. For each age x in status i we could give the probability of ending up in state j at any greater age y . Since there are 35 age groups and 12 statuses, the model provides 90,720 such conditional probabilities. On top of this, our model results in a maximum of 5040 ($12 \cdot 12 \cdot 35$) mean sojourn times or life expectancies in the various statuses given that a person is in status i at age x . The hierarchical nature of parity progression and first marriage, however, reduces the number of possible transitions somewhat in our model.

In order to get any information out of this great amount of numbers we will ask very specific questions and see what answer the model can give us. Tables 2 to 6 give results for four such selective questions based on the transition patterns observed in Austria 1981-1986.

1. *How does a pre-marital birth influence a woman's later marital status?*

Table 2 compares the marital status distributions for women at ages 30, 40, and 50 given that they were unmarried with children at ages 20, 25, and 30, or unmarried without children at those ages. The figures given in the table are percentages. The figure of 39.94 in the lower right corner of Table 2, for instance, indicates that about 40% of all women who were unmarried with one or more children at age 30 were still unmarried at age 50. This compares with about 60% of the women unmarried but childless at age 30. From this we may conclude that the probability of remaining unmarried is clearly lower

Table 1. Initial distribution of female population in Austria over the 12 family states, 1985.

	0-4	5-9	10-14	15-19	20-24	25-29	30-34	35-39	40-44	45-49
Single, no children	222000	209000	244000	279000	158000	57200	17800	10800	14900	10600
Single, 1+ children	0	0	0	6850	29100	15500	7890	5950	4350	4190
Married, no children	0	0	0	9860	37400	28400	19500	15500	14300	10700
Married, 1 child	0	0	0	5650	52600	68600	56900	44600	43700	37100
Married, 2 children	0	0	0	1510	36600	83600	87200	84100	69500	58600
Married, 3+ children	0	0	0	115	4430	28900	48700	62600	78400	80300
Widowed, no children	0	0	0	0	0	390	49	216	721	1210
Widowed, 1 child	0	0	0	0	875	136	856	614	1820	2120
Widowed, 2+ children	0	0	0	0	0	740	1630	3140	5330	8570
Divorced, no children	0	0	0	0	3210	2680	1820	3280	1740	1750
Divorced, 1 child	0	0	0	0	2900	4900	3260	7450	12100	5060
Divorced, 2+ children	0	0	0	0	1240	3250	6620	11000	12100	7570
Total	222000	209000	244000	303000	326000	294000	252000	249000	259000	228000

for women with pre-marital births in Austria. This pattern is also visible for all other ages considered in the table.

Table 2. How does a pre-marital birth influence a woman's later marital status (Austria 1981-1986)?

	Status at age 20		Status at age 25		Status at age 30	
	Single, no children	Single, children	Single, no children	Single, children	Single, no children	Single, children
Age	Proportions Single at ages 30, 40, 50 (in percent)					
30	31.13	12.03	57.54	46.57	-	-
40	19.58	6.10	37.10	23.63	66.45	50.75
50	17.18	4.80	32.91	18.60	59.68	39.94
Age	Proportions Married at ages 30, 40, 50 (in percent)					
30	64.21	82.20	40.65	51.46	-	-
40	70.09	82.21	55.49	67.92	30.29	44.53
50	65.22	75.91	52.87	65.68	31.68	49.28
Age	Proportions Divorced at ages 30, 40, 50 (in percent)					
30	3.60	4.16	1.39	1.39	-	-
40	7.29	7.91	5.56	5.72	1.99	2.97
50	9.02	9.87	6.81	7.80	3.15	4.62

For the married state the same phenomenon results in the fact that at any age women that are single with children have a higher probability of being in the married state than do childless unmarried women. As to the probability of being in the divorced state the pattern is less clear. Generally women with a pre-marital birth tend to have a higher probability of being in the divorced state at the given ages. The percentages in the divorced state are rather low because of remarriage. Since the probability of remarriage also depends on the number of children the pattern is difficult to interpret.

In answering the question it may be said that women with a pre-marital birth tend to marry sooner and to a greater extent than do childless unmarried women of the same age.

2. *How does the number of children in a marriage affect the probability of being divorced at a later age?*

Table 3 gives the proportions of women that are divorced at ages 30–50 for women married at age 25 with different family sizes. The pattern shows that the lower the number of children, the higher the probability of living in the divorced state at ages 30–50. But again differential speed and intensity of remarriage might distort the picture. A chaining of age-specific divorce probabilities shows that childless marriages tend to end in divorce by 38%, marriages with one child by 28%, with two children by 20%, and with three or more children by only 15%. Hence, the Austrian data imply that the lower the number of children for 25-year-old married women, the higher the probability of divorce at later ages.

Table 3. How does the number of children for married women affect the probability of being divorced at certain ages (Austria 1981–1986)?

Proportions Divorced at ages 30, 40, 50 (in percent)

Status at age 25				
Age	Married, no children	Married, 1 child	Married, 2 children	Married, 3+ children
30	4.63	3.75	2.75	3.43
40	9.55	8.55	7.21	6.38
50	11.56	10.84	9.22	8.07

Status at age 35				
Age	Married, no children	Married, 1 child	Married, 2 children	Married, 3+ children
40	3.73	6.12	3.88	2.37
50	8.13	9.85	6.82	4.70

3. *How does the number of children affect the probability of remarriage after divorce?*

Table 4 shows the proportions of women married at ages 40–50 that were divorced or widowed with different numbers of children at ages 30 and 40. The table indicates that the probabilities of being remarried after divorce are clearly highest for childless women, but also women with only one child seem to remarry faster and to a larger extent than women with two or more children. It becomes also clear from the table that the probabilities of being remarried after 10 years are much lower for women aged 40 than for women aged 30. Hence we may summarize that a younger age and a smaller number of children both tend to increase the probability of remarriage after divorce.

Table 4. How does the number of children influence remarriage after divorce (Austria 1981-1986)?

Proportions Married at ages 40 and 50 (in percent)

Status at age 30			
Age	Divorced, no children	Divorced, 1 child	Divorced, 2+ children
40	53.14	40.66	33.14
50	60.90	43.07	36.16

Status at age 40			
Age	Divorced, no children	Divorced, 1 child	Divorced, 2+ children
45	43.86	9.54	6.05
50	44.93	10.93	9.79

4. *How many years does a woman on average spend in the different family statuses?*

The first column of Table 5a gives the mean durations spent in different statuses up to age 50 for all women (= unmarried childless women at age 15). The values given in years may not be interpreted as a "typical" life cycle. It rather is the average of all life cycles that results in some fractions of the life between age 15 and 50 spent in each status. The figures result from a combination of the probabilities of getting into the status and the mean duration of staying in the status. But there is most probably not a single woman that actually lives through all the states. Nevertheless, this kind of table has interesting implications for the population as an aggregate. Table 5b that gives the percentage distribution of time spent in the various states may also be interpreted as the actual population distribution in a stationary population and has, aside from academic interest, impact on several questions of social policy.

By far the greatest proportion (one third) of the life between ages 15 and 50 of all women is spent in the status unmarried and childless. Next comes the status married with two children in which on average 20% of the time between 15 and 50 is spent. More than half (55%) of the life between ages 15 and 50 is spent in marriage when no distinction is made between different parities. Only about 4% of the period (or less than two years) are spent in the divorced state. This small proportion despite high divorce probabilities is caused by the rather great speed and high incidence of remarriage in the relevant age groups.

Table 5a. Life expectancies: years of remaining life (up to age 50) spent on the average in different family statuses given initial age and status (Austria 1981–1986).

	Initial status:								
	Single, no children at age 15	Single, 1+ children at age 20	Married, no children at age 20	Married, 1 child at age 20	Married, no children at age 30	Married, 1 child at age 30	Single, no children at age 30	Divorced, 1 child at age 30	Widowed, 1+ children at age 40
Single, no children	11.5	–	–	–	–	–	12.4	–	–
Single, 1+ children	1.9	4.9	–	–	–	–	1.6	–	–
Married, no children	3.3	–	2.9	–	10.5	–	3.6	–	–
Married, 1 child	5.5	5.3	6.5	6.1	5.4	11.9	1.2	5.0	1.1
Married, 2 children	7.0	10.9	11.3	12.9	1.5	5.3	0.4	2.1	0.0
Married, 3+ children	3.3	6.4	5.9	7.7	0.2	0.9	0.1	0.2	0.0
Widowed, no children	0.1	–	0.0	–	0.3	–	0.1	–	–
Widowed, 1 child	0.1	0.2	0.2	0.3	0.1	0.2	0.0	0.1	8.8
Widowed, 2+ children	0.2	0.4	0.4	0.5	0.0	0.1	0.0	0.5	0.0
Divorced, no children	0.3	–	0.3	–	1.0	–	0.3	–	–
Divorced, 1 child	0.6	0.5	0.9	0.6	0.6	1.0	0.1	9.1	0.0
Divorced, 2+ children	0.7	1.2	1.3	1.5	0.1	0.4	0.0	3.2	0.0

Table 5b. Life expectancies: percentage of remaining life (up to age 50) spent on the average in different family statuses given initial age and status (Austria 1981-1986).

	Initial status:								
	Single, no children at age 15	Single, 1+ children at age 20	Married, no children at age 20	Married, 1 child at age 20	Married, no children at age 30	Married, 1 child at age 30	Single, no children at age 30	Divorced, 1 child at age 30	Widowed, 1 child at age 40
Single, no children	33.26	-	-	-	-	-	62.61	-	-
Single, 1+ children	5.40	16.38	-	-	-	-	8.14	-	-
Married, no children	9.58	-	9.77	-	53.18	-	18.07	-	-
Married, 1 child	15.92	17.82	21.94	20.73	27.32	60.25	5.94	25.51	10.95
Married, 2 children	20.23	36.81	37.95	43.65	7.55	26.72	2.14	10.82	0.16
Married, 3+ children	9.53	21.42	19.95	25.91	0.93	4.37	0.37	1.14	0.00
Widowed, no children	0.21	-	0.08	-	1.36	-	0.51	-	-
Widowed, 1 child	0.38	0.53	0.73	1.01	0.54	1.21	0.12	0.50	88.51
Widowed, 2+ children	0.67	1.31	1.29	1.56	0.19	0.69	0.06	0.26	0.00
Divorced, no children	0.92	-	0.97	-	5.28	-	1.32	-	-
Divorced, 1 child	1.82	1.79	3.03	2.09	3.10	4.81	0.59	45.83	0.37
Divorced, 2+ children	2.10	3.96	4.29	5.04	0.56	1.95	0.14	15.94	0.00

All the other distributions over family statuses given in Tables 5a and b refer to selected categories of women that are at a given age in a given status. Most of the phenomena described above are mirrored in these data and shall not be described in greater detail here. When comparing the tables from left to right, the most evident pattern is probably the fact that the older the woman, the higher the proportions and the absolute number of years of her remaining life spent in the status she is currently in. This mainly reflects the fact that transition intensities are lower at higher ages.

SCENARIOS FOR FUTURE FAMILY STATUS DISTRIBUTIONS

Based on the given distribution (Table 1) of the Austrian population in 1986 over the 12 family statuses defined in our model, it is possible to project future distributions under various assumptions on transition intensities between the states. For this purpose we used the Dialog system (Scherbov and Grechucha 1988). A reference scenario would be the case in which the empirically observed pattern of transitions in 1981–1986 is assumed to continue unchanged. If this pattern is applied for many years to the initial distribution which resulted from different historical patterns, the resulting distribution will come closer and closer to the stable distribution that is implied by the given set of transition ratios. In our study we call the case of stable transition rates scenario 0.

The number of possible scenarios is virtually unlimited. When applying 28 different transition rates and each for 35 single-year age groups over 45 single years in time, we have more than 45,000 parameters and theoretically all could be changed in any combination. In order to evaluate a few distinct scenarios and compare their results we have to be extremely selective again, and make assumptions that might seem quite arbitrary. The definition of scenarios 1 to 3 in this study was guided by the thought that there are two general sets of alternatives for the future course of family dynamics: low versus high fertility and marriage rates, and homogeneity versus heterogeneity. The question of heterogeneity refers to the variance in the distribution, whether all women have fertility levels around a given low or high mean, or whether the mean results from averaging two very different (high and low fertility) groups of women. Out of the four possible combinations resulting from the cross-classification of these two criteria, three were thought to make not implausible scenarios: further decline in marriage and fertility rates—homogeneous (scenario 1); further decline in marriage and fertility—heterogeneous (scenario 2); a new marriage and baby boom—homogeneous (scenario 3). In the specification of the scenarios the main difference between the homogeneous and heterogeneous cases lies in the parity progression ratios where the homogeneous scenario has rather high ratios at parities 0 and 1 and low ratios at parity 2, whereas the heterogeneous one is low at parity 0 and higher at the other parities.

The setting of the new parameters for the scenario was done by the following procedure (for the numerical values see Table 6): for each transition in the empirical data the integral under the curve of age-specific rates is calculated (given in the first column of Table 6); next a point in time was set (here 2010) by which the integral should reach a newly specified value (given in other columns of Table 3); between the two points (1986 and 2010) the values are calculated by linear interpolation; finally all age-specific transition rates are changed proportionally in order to produce the new value of the integral.

Table 6. Specification of scenario settings. The values refer to the integral under the curve of age-specific transition rates.

Transition	Observed value 1981-1986 = Scenario 0	Value changes gradually to ... in 2010 and remains constant thereafter		
		Scenario 1	Scenario 2	Scenario 3
S0 → S1+	.615	.4	.4	.4
S0 → M0	1.634	1.3	1.3	2.0
S1+ → M1	2.513	constant	1.5	3.0
S1+ → M2	.850	constant	.5	2.0
M0 → M1	5.302	constant	3.0	6.0
M0 → D0	.483	1.0	1.0	.2
M1 → M2	2.849	constant	2.0	4.0
M1 → D1	.322	.6	.6	.2
M2 → M3+	.877	.4	constant	constant
M2 → D2+	.217	.4	.4	.1
D0 → M0	2.797	.2	.2	.4

All other transition rates are assumed to be constant as observed in 1981-1986.

Hence, in these scenarios we do not assume any change in the general pattern of age-specific transition ratios but only scale those rates up or down proportionally.

Table 7 gives the absolute numbers of women in each status by five-year age groups under the different scenarios by the year 2030. Since assumptions on the parity progression ratios also affect the average level of fertility and consequently the size of younger cohorts, the different scenarios will also result in different total population sizes by the year 2030. As we can see from the table only the number of women in the oldest age group 45-49 is invariant over the scenarios because they were already born 1981-1986. The distribution of those women over the various family-statuses is greatly affected by the scenario assumptions. In terms of the size of younger cohorts in 2030 clearly the scenario assuming a modest new baby boom (scenario 3) results in the largest cohorts, whereas scenarios 1 and 2 have about the same effect on population size which will sharply decline because those assume low fertility. As compared to the reference scenario 0 (constant rates) scenarios 1 and 2 will result in lower cohort sizes whereas scenario 3 will result in higher ones. Compared to the sizes of age groups in 1986 all age groups considered (i.e. up to 45-49) will decrease by the year 2030.

But since this study is not so much interested in total cohort sizes but in the changing distribution of women over family statuses, the following graphs will illustrate results of the alternative projections for selected statuses. Most of the graphs will give the changes over time in absolute or relative numbers of women of selected age groups in a given status; other figures give the age distributions in a status in 1985 as compared to the results of the three scenarios in 2030. Some 3-D graphs finally try to cover both aspects.

Table 7. Age-specific distributions over the 12 family statuses in Austria in 2030 as resulting from the four different scenarios.

	0-4	5-9	10-14	15-19	20-24	25-29	30-34	35-39	40-44	45-49
Scenario 0										
S0	124000	134000	146000	139000	79000	41300	25700	23800	23600	22800
S1+	0	0	0	5220	12900	11400	10300	10600	10400	9470
M0	0	0	0	5430	20100	19800	19600	20700	21300	21400
M1	0	0	0	3180	25000	35500	38300	38900	38200	37900
M2	0	0	0	899	16000	39500	52400	59300	59500	57600
M3+	0	0	0	64	1950	10800	24800	34300	36200	35400
W0	0	0	0	0	4	126	226	322	1050	1680
W1	0	0	0	0	312	401	600	813	1420	2500
W2+	0	0	0	0	26	273	696	1700	3190	5370
D0	0	0	0	44	1190	1370	2440	2640	2540	2660
D1	0	0	0	20	1050	3120	2990	5200	7080	7440
D2+	0	0	0	1	406	1310	3540	6160	8710	9870
Total	124000	134000	146000	154000	158000	165000	182000	205000	213000	214000
Scenario 1										
S0	84300	96100	109000	110000	76100	49800	37600	38200	39100	36600
S1+	0	0	0	2690	7500	7640	7960	8890	9080	8300
M0	0	0	0	3450	14000	15900	17000	17800	16600	16000
M1	0	0	0	1920	15900	25400	30100	31400	30900	31000
M2	0	0	0	523	10400	29900	45500	55200	57200	57000
M3+	0	0	0	30	660	3780	9750	14500	16500	17700
W0	0	0	0	0	3	100	190	283	870	1330
W1	0	0	0	0	197	276	444	640	1170	2090
W2+	0	0	0	0	16	165	481	1270	2490	4430
D0	0	0	0	58	1920	3140	6560	8720	11500	12200
D1	0	0	0	24	1330	4540	4710	8900	12000	12500
D2+	0	0	0	2	457	1530	4600	8520	13000	14900
Total	84300	96100	109000	119000	128000	142000	165000	194000	210000	214000
Scenario 2										
S0	65700	77500	89700	91900	65800	45200	35300	36900	38700	36600
S1	0	0	0	2430	8440	10300	11800	13900	14800	13900
M0	0	0	0	3410	16600	22200	24800	26700	25300	23700
M1	0	0	0	1110	11400	22600	30300	33500	34100	34300
M2	0	0	0	225	4900	15000	23600	29500	31800	33600
M3+0	0	0	28	665	4070	10900	16500	19600	22000	
W0	0	0	0	0	4	136	269	416	1330	2000
W1	0	0	0	0	125	209	383	603	1210	2240
W2+	0	0	0	0	8	101	293	811	1710	3240
D0	0	0	0	58	2190	4090	9240	12700	17300	17900
D1	0	0	0	17	1050	4420	4920	10000	13700	14100
D2+	0	0	0	1	237	929	3230	5790	8660	10400
Total	65700	77500	89700	99100	111000	129000	155000	187000	208000	214000
Scenario 3										
S0	154000	163000	173000	162000	87100	41600	24100	21500	20800	20000
S1	0	0	0	3620	7350	5550	4320	3860	3660	3420
M0	0	0	0	7350	25500	22700	21300	21500	20800	21000
M1	0	0	0	4090	27300	32900	31700	30700	29400	29300
M2	0	0	0	1610	25500	57000	70500	76900	75800	72500
M3+	0	0	0	56	2840	15600	34000	45400	46100	43500
W0	0	0	0	0	5	148	256	350	1050	1660
W1	0	0	0	0	373	429	581	729	1160	2010
W2+	0	0	0	0	45	403	975	2270	4070	6680
D0	0	0	0	25	712	957	1710	2050	2530	2810
D1	0	0	0	15	712	1930	1740	2840	3680	3950
D2+	0	0	0	1	325	1070	2750	4690	6340	7230
Total	154000	163000	173000	179000	178000	180000	194000	213000	215000	214

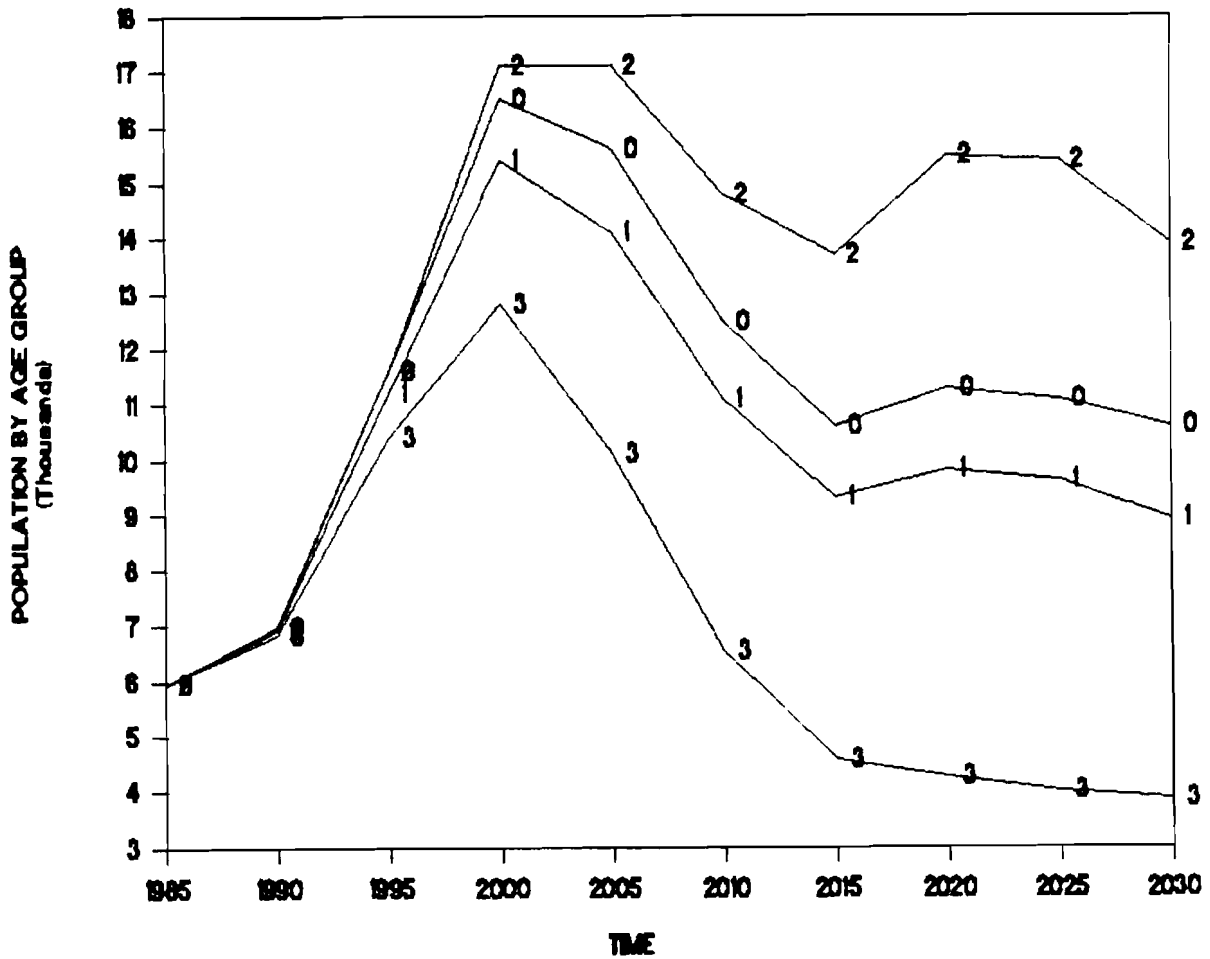

Figure 1. Absolute numbers of unmarried women aged 35-39 with children 1985-2030 for scenarios 0 to 3.

Figures 1 and 2 present the results for the category of unmarried women with one or more children, a group that is of considerable interest for social policy. In Figure 1 the age group 35-39—an age at which the probabilities of marriage become rather low—we see that under all scenarios the number of single mothers is expected to peak around 2000 and decline thereafter at a different speed according to the scenario specifications. This is mostly a function of the changes in cohort size.

Comparing across different age groups (Figure 2) we see that the pattern in 1985 grossly deviates from all the scenario results in 2030. In 1985 the number of single mothers clearly peaks in the age group 20-24 which again is mostly the consequence of the age structure of the population. From the comparison of this to the result of scenario 0 (constant rates) we may conclude that even under unchanged rates of illegitimacy, the

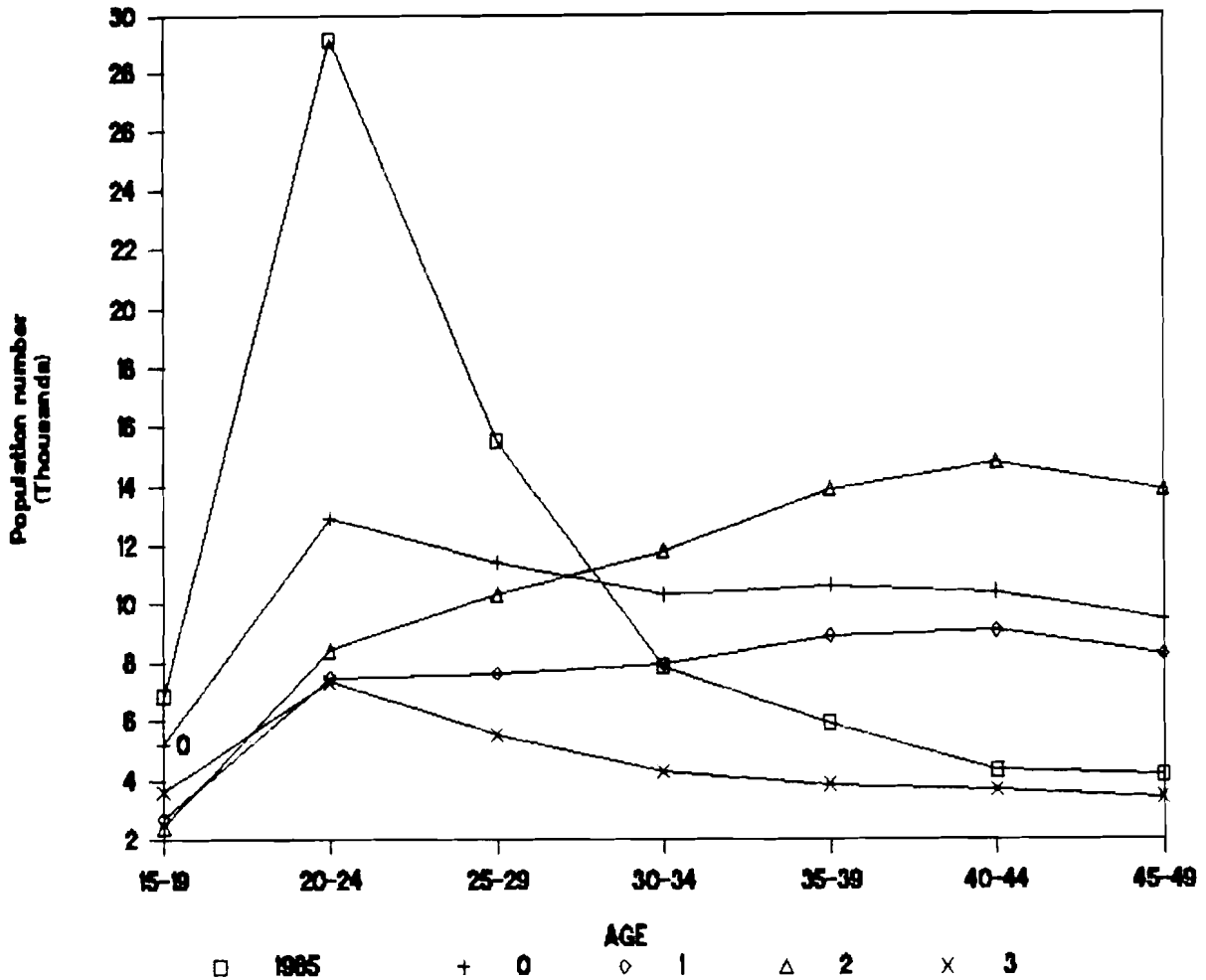

Figure 2. Absolute numbers of unmarried women by five-year age groups in 1985 and 2030 under scenarios 0 to 3.

number of single mothers under age 30 will greatly diminish in the future. Only extreme boom in illegitimate fertility could change this pattern.

In contrast to the above, the number of married women with two children depends greatly on the differential assumptions made in the scenarios. Figures 3 a-c give 3-D images of the change of absolute numbers of women in this category over age and time. We see that under the current pattern of age-specific fertility marriage and divorce rates (scenario 0), the number of married women with two children will clearly decline up to 2030. From the graph we can also see that the decline was steepest for the cohort aged 25-29 in 2000. The diagonal cohort line for this specific cohort is clearly visible in the graph. After that the number of married women with two children even recovers somewhat. Figure 4 which gives the proportions of all women in the given age group that are

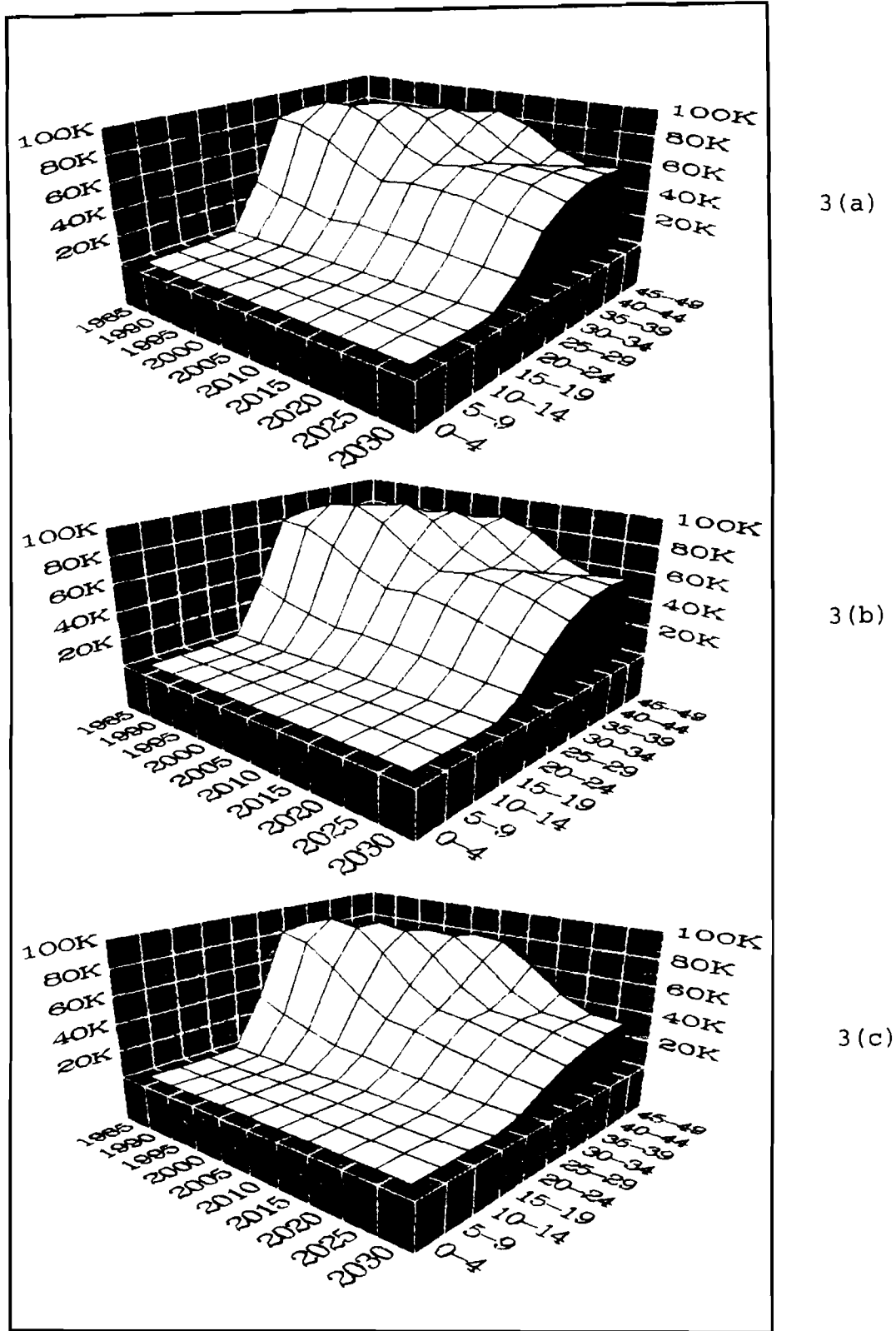

Figure 3. Changes in the absolute numbers of married women with two children for all age groups (right axis) and the years 1985-2030 (left axis) under scenarios 0 (3a), 1 (3b), and 2 (3c).

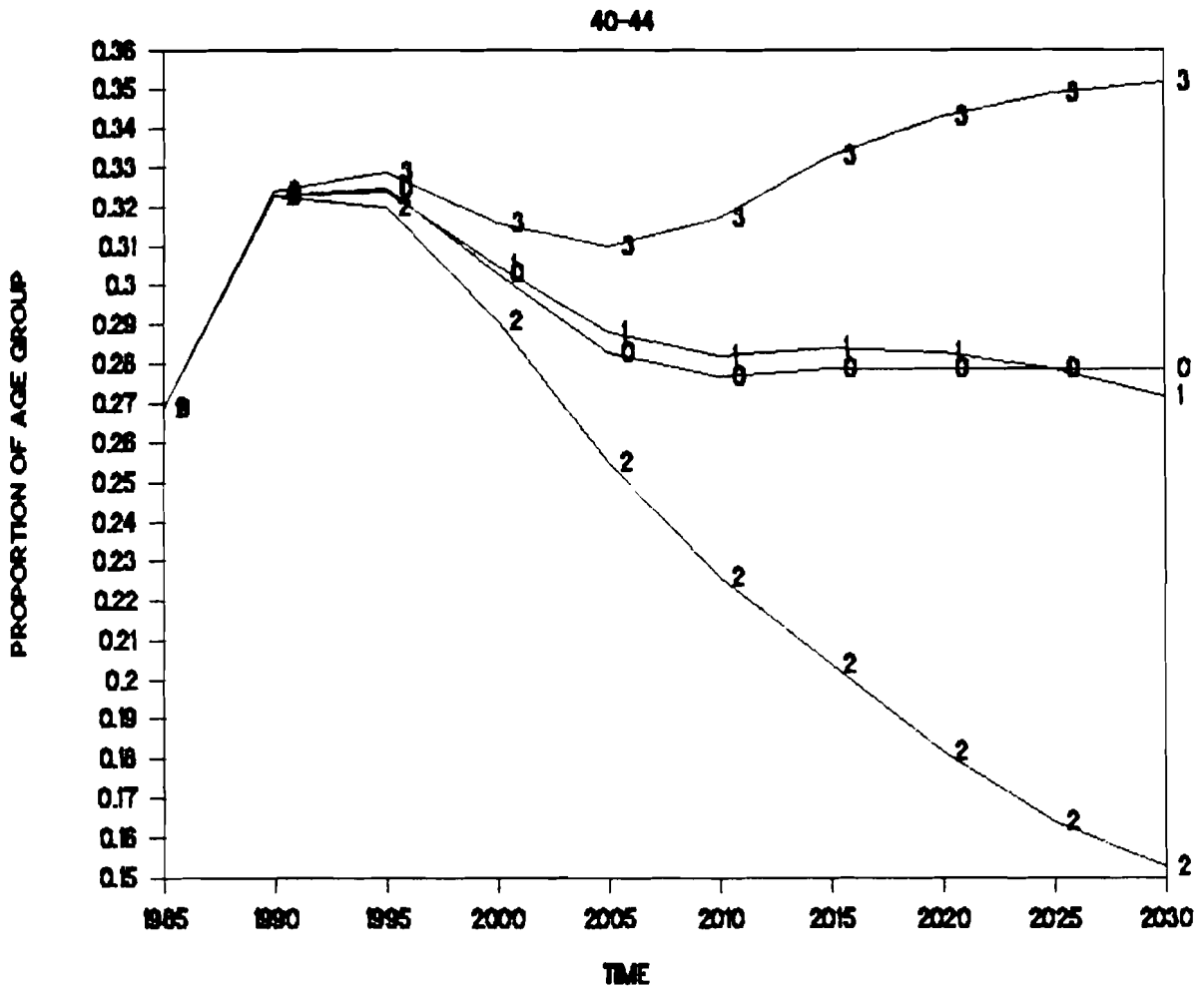

Figure 4. Proportion of all women aged 40-44 that are married with two children for scenarios 0 to 3, 1985-2030.

in the status married with two children indicates that this pattern is not only due to changing cohort sizes. In the figure we can see that for scenario 0 the proportion of women in the category at age 40-45 first increases, then peaks around 1995 and enters a steep decline thereafter until 2010 when it stabilizes.

Figure 3 also makes the difference between the homogeneous (scenario 2) and the heterogeneous case (scenario 3) very clear. Although the total numbers of children born are not very different in the two scenarios, the homogeneous case results in a high number of married women with two children whereas the heterogeneous case results in a very low number. This is true for all age groups but to a greater extent for the older ones because the younger age groups in the heterogeneous case may have the two-child situation also as a transient state. For the age group 45-49 this difference is most pronounced and we see from Figure 4 that in the homogeneous case the proportion of women in the state married

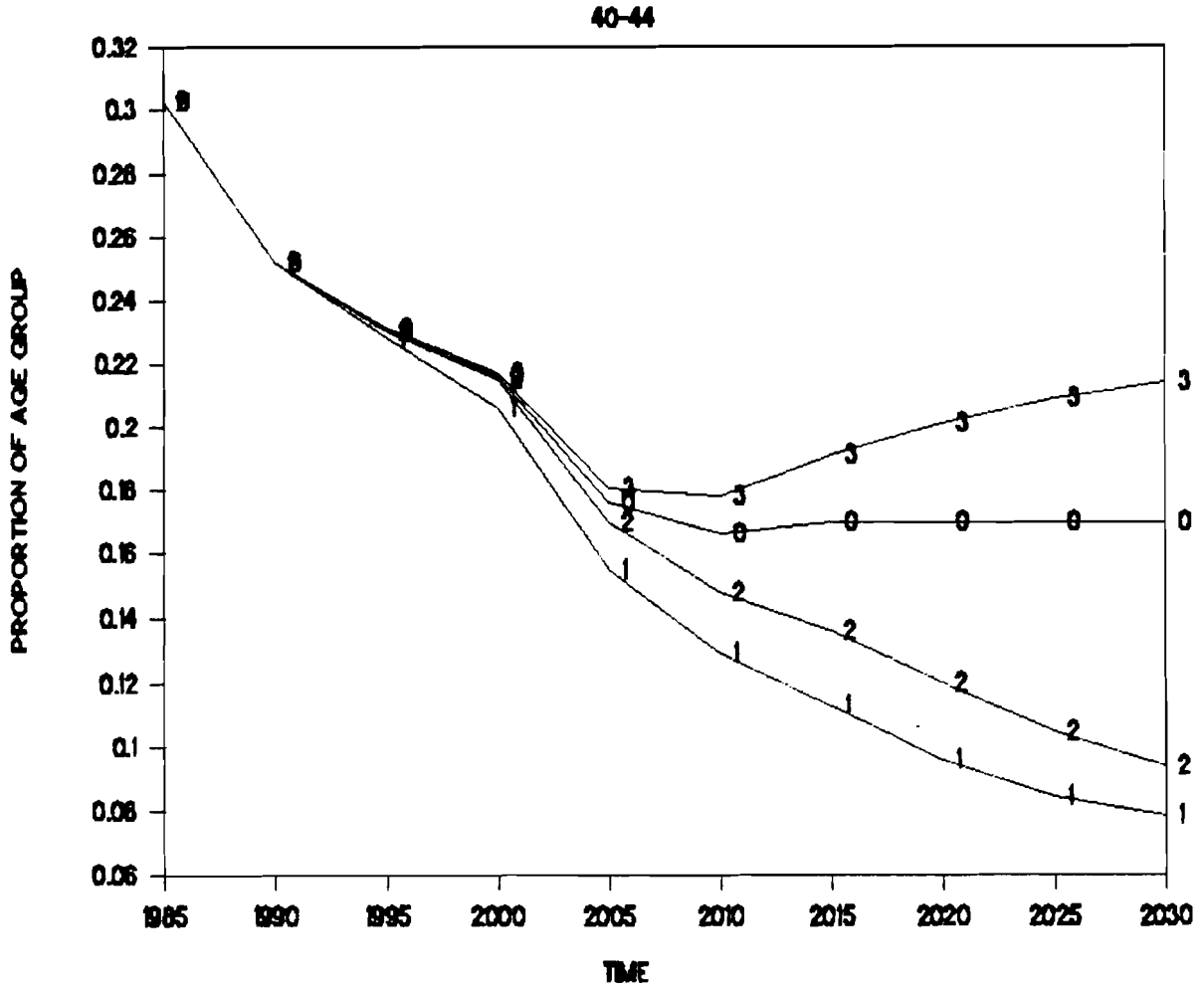

Figure 5. Proportion of all women aged 40-44 that are married with three or more children for scenarios 0 to 3, 1985-2030.

with two children in 2030 is almost twice as high (28%) than in the heterogeneous case (15%).

Figure 5 finally gives the proportions of married women with three or more children in the age group 40-45. We see that this proportion declines significantly for all scenarios to almost half its 1985 value by the year 2005. Thereafter it changes according to the different scenario specifications. The fast decline to be expected over the next 20 years is still a consequence of the past fertility decline during the 1970s because the women that are aged 40-45 in 1985 still participated in the high fertility of the outgoing baby boom.

Another group of considerable interest from a social point of view is the number of divorced women with two or more children. Figure 7 indicates that this group is strongest at ages above 40. In this figure all scenarios show a rather similar pattern with differences only in the extent of increase with age. For the age group 40-45 (see Figure 6)

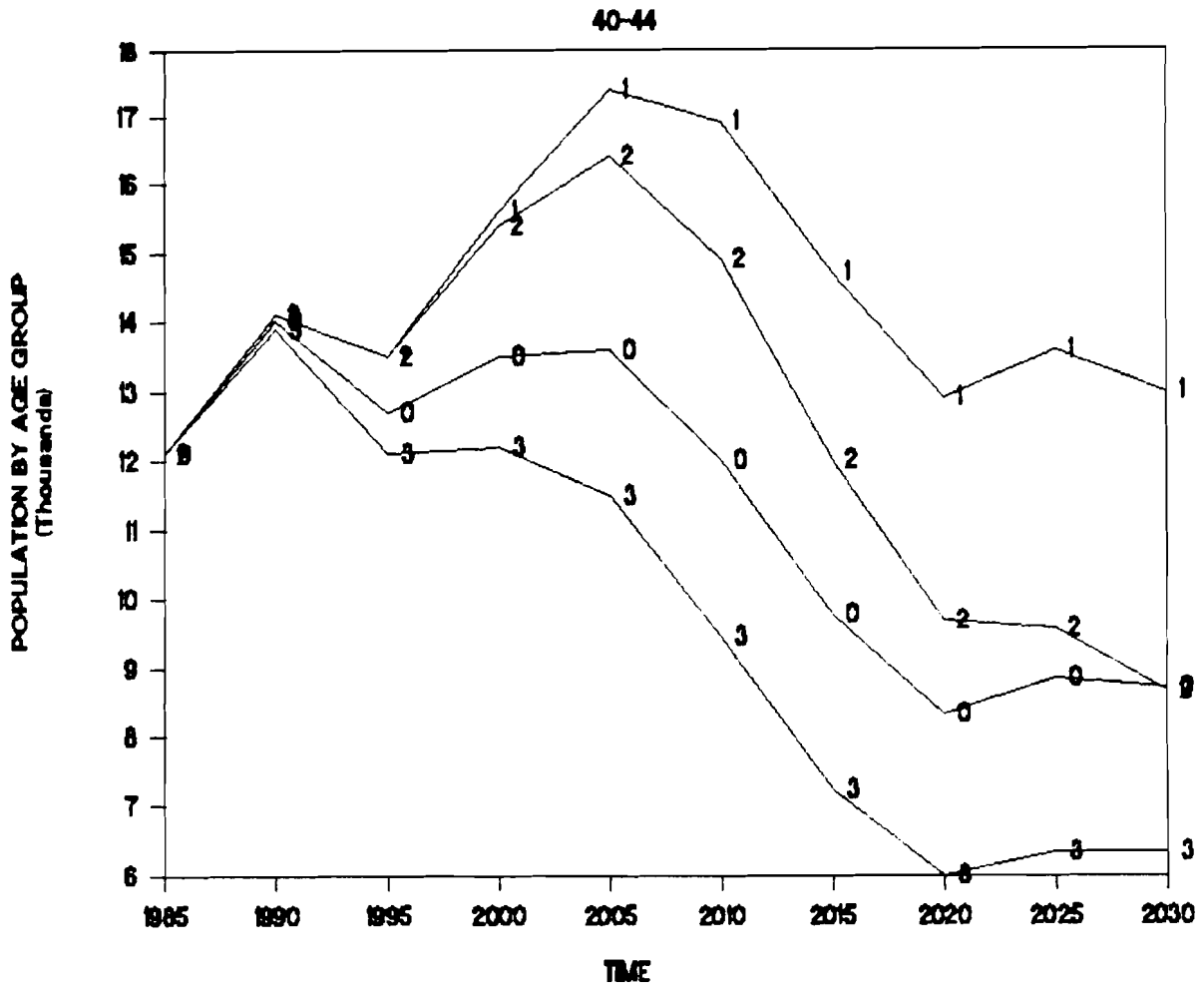

Figure 6. Absolute numbers of women aged 40-44 in the state divorced with two or more children for the four different scenarios, 1985-2030.

we find a great variety of possible future trends in the number of divorced women with two children. The greatest difference is between scenario 3 which assumed a new marriage and baby boom that is accompanied with lower divorce and higher remarriage rates and scenario 1 which assumes a homogeneous fertility decline.

CONCLUSION

This paper had two parts that illustrate two different ways of using multi-state models in family demography: analysis and projection. The analysis of current patterns of family dynamics helps to understand the nature of recent behavior and its implication for the future structure of the population. The projection part goes one step further in not only pointing at the consequences of current behavior but in defining scenarios on possible future trends in family dynamics. But as we saw from the study the impact of

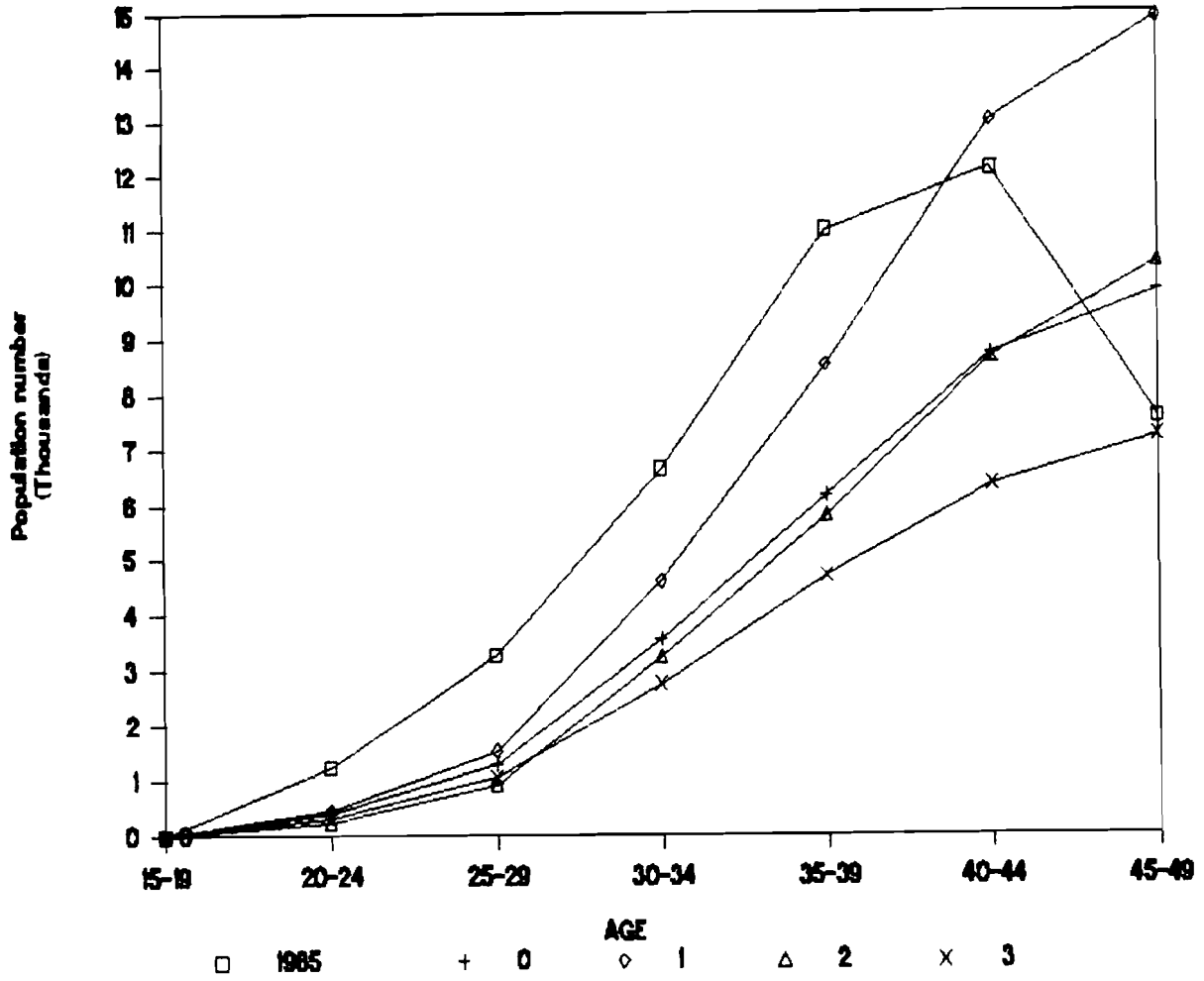

Figure 7. Absolute numbers of women in the state divorced with two or more children by age groups for 1985 and 2030 under scenarios 0 to 3.

present behavior alone is great enough to change the distribution of family statuses in the future significantly. Alternative assumptions on future trends tend to even reinforce those changes—except for the not very likely case of a new baby boom.

REFERENCES

- Aufhauser, Elisabeth and Wolfgang Lutz (1987) *Demographische Analyse des familienbezogenen Lebenszyklus österreichischer Frauen*. Vienna: Institut für Demographie.
- Elder, Jr., Glen H. (1977) Family History and the Life Course. *Journal of Family History* 2(4):279-304.
- Espenshade, Thomas J. (1983) Marriage, Divorce, and Remarriage from Retrospective Data: A Multiregional Approach. *Environment and Planning A* 15:1633-1652.
- Espenshade, Thomas J. and Rachel Eisenberg Braun (1982) Life Course Analysis and Multistate Demography: An Application to Marriage, Divorce, and Remarriage. *Journal of Marriage and the Family* 44:1025-36.
- Glick, Paul C. (1947) The Family Cycle. *American Sociological Review* 12:164-174.
- Glick, Paul C. (1977) Updating the Life Cycle of the Family. *Journal of Marriage and the Family* 39(1):5-13.
- Höhn, Charlotte (1982) Der Familienzyklus – Zur Notwendigkeit einer Konzepterweiterung (The Family Life Cycle: On the Necessity for an Extension of the Concept). *Schriftenreihe des Bundesinstituts für Bevölkerungsforschung*, Band 12. Boppard am Rhein: Boldt-Verlag.
- Keyfitz, N. (1980) Multidimensionality in Population Analysis. Chapter 7. Pages 191-218 in *Sociology Methodology*, edited by Karl Schuessler. San Francisco: Jossey-Bass.
- Krishnamoorthy, S. (1979) Classical Approach to Increment-Decrement Life Tables: An Application to the Study of the Marital Status of United States Females, 1970. *Mathematical Biosciences* 44:139-154.
- Kuijsten, A. (1986) *Advances in Family Demography*. NIDI/CBGS Publication Nr. 14. The Hague/Brussels.
- Land, Kenneth and Andrei Rogers (Eds.) (1982) *Multidimensional Mathematical Demography*. London.
- Nock, Steven L. (1979) The Family Life Cycle: Empirical or Conceptual Tool? *Journal of Marriage and the Family* 41(1):15-26.
- Norton, Arthur J. (1983) Family Life Cycle: 1980. *Journal of Marriage and the Family* 45(2):267-275.
- Rogers, Andrei (1975) *Introduction to Multi-regional Mathematical Demography*. New York: John Wiley.
- Scherbov, Sergei and Vladimir Grechucha (1988) "DIALOG" – A System for Modeling Multidimensional Demographic Processes. WP-88-36. Laxenburg, Austria: International Institute for Applied Systems Analysis.
- Schoen, Robert (1975) Constructing Increment-Decrement Life Tables. *Demography* 12:313-324.
- Schoen, Robert and V.E. Nelson (1974) Marriage, Divorce, and Mortality: A Life Table Analysis. *Demography* 11:267-290.
- Schoen, Robert and L.U. Urton (1979) *Marital Status Life Tables for Sweden: Years 1911-1979 and Cohorts Born 1885-89 to 1940-44*, Volume 10. Stockholm: National Central Bureau of Statistics.
- Suchindran, C.M., N.K. Namboodiri, and K. West (1977) Analysis of Fertility by Increment-Decrement Life Tables. *Proceedings of the American Statistical Association, Social Statistics Section* 1:431-436.
- Willekens, F., I. Shah, J.M. Shah, and P. Ramachandran (1982) Multi-state Analysis of Marital Status Life Tables: Theory and Application. *Population Studies* 36(1):129-144.

**Recent Working Papers Produced in
IIASA's Population Program**

Copies may be obtained at a cost of US \$ 5.00 each from IIASA's
Publications Department.

- WP-87-51, *The Concentration of Reproduction: A Global Perspective* by W. Lutz. June 1987.
- WP-87-58, *A Simple Model for the Statistical Analysis of Large Arrays of Mortality Data: Rectangular vs. Diagonal Structure* by J. Wilmoth and G. Caselli. June 1987.
- WP-87-59, *Sibling Dependences in Branching Populations* by P. Broberg. June 1987.
- WP-87-87, *The Living Arrangements and Familial Contacts of the Elderly in Japan* by K. Hiroshima. September 1987.
- WP-87-92, *The Demographic Discontinuity of the 1940s* by N. Keyfitz. September 1987.
- WP-87-104, *A Random-Effects Logit Model for Panel Data* by D. Wolf. October 1987.
- WP-87-116, *Some Demographic Aspects of Aging in the German Democratic Republic* by T. Büttner, W. Lutz, and W. Speigner. November 1987.
- WP-88-10, *On the Concentration of Childbearing in China, 1955-1981* by W. Lutz. February 1988.
- WP-88-13, *Beyond "The Average American Family": U.S. Cohort Parity Distributions and Fertility Concentration* by M. King and W. Lutz. March 1988.
- WP-88-23, *Understanding Medical and Demographic Trends with MEDDAS* by M. Rusnak and S. Scherbov. April 1988.
- WP-88-32, *Kinship Patterns and Household Composition of the Elderly: Hungarian Women, 1984* by D. Wolf. April 1988.
- WP-88-36, *"DIAL" - A System for Modeling Multidimensional Demographic Processes* by S. Scherbov and V. Grechucha. May 1988.
- WP-88-44, *Kin Availability and the Living Arrangements of Older Unmarried Women: Canada, 1985* by D. Wolf, T. Burch, and B. Matthews. June 1988.
- WP-88-46, *Population Futures for Europe: An Analysis of Alternative Scenarios*, by D. Wolf, B. Wils, W. Lutz, and S. Scherbov. June 1988.
- WP-88-90, *Comparative analysis of Completed Parity Distributions: A Global WFS-Perspective*, by W. Lutz. October 1988.
- WP-88-104, *Future Regional Population Patterns in the Soviet Union: Scenarios to the Year 2050*, by S. Scherbov and W. Lutz. November 1988.
- WP-88-120, *AIDS and HIV Surveillance in Europe*, by M. Artzrouni and G. Heilig. December 1988.
- WP-88-124, *DDMSLT: A Computer Program for Estimating the Duration-Dependent Multistate Life Table Model*, by C. Calhoun. December 1988.