

IIASA

**PROCEEDINGS OF
THE WORKSHOP ON
ENERGY DEMAND**

May 22 - 23, 1975
William D. Nordhaus, Editor

CP-76-1

PROCEEDINGS OF THE WORKSHOP ON ENERGY DEMAND

**May 22 - 23, 1975
William D. Nordhaus, Editor**

The views expressed are those of the contributors and not necessarily those of the Institute.

The Institute assumes full responsibility for minor editorial changes made in grammar, syntax, or wording, and trusts that these modifications have not abused the sense of the writers' ideas.

**International Institute for Applied Systems Analysis
2361 Laxenburg, Austria**

Preface

The Workshop on Energy Demand was held by the International Institute for Applied Systems Analysis (IIASA) at Schloss Laxenburg, Austria, May 22-23, 1975, as part of the Energy Systems Project. The Energy Project was started in 1973 under the leadership of Professor Wolf Häfele. Professor William D. Nordhaus of IIASA and Yale University (USA) was the overall chairman of the Workshop. The Workshop was devoted to the understanding and modelling of energy demand, both from an engineering and from a behavioral point of view.

Fifty-five people from fifteen countries East and West attended the Workshop. The participants are directly involved in energy demand modelling--in government energy planning offices, in research divisions of the energy industry (mostly coal and electricity), in university or non-profit research institutes. In a number of instances the participants came from all three areas of activities within the same country.

The twenty-nine papers submitted to the Workshop were discussed under five headings: I. Methodology; II. Individual Sectors; III. Individual Economies: 3.1 Eastern Europe and the USSR; 3.2 Western Europe; 3.3 North America and Others; IV. International Studies; and V. Linkages to the Rest of the Economy.

The Workshop proceedings begin with welcoming addresses by Professors Häfele and Nordhaus, and they are followed by the papers presented at the Workshop and summaries of the discussions. The Workshop concludes with Professor Nordhaus' overview of the issues and problems discussed by the Workshop.

This volume of the proceedings was prepared by Professor Nordhaus and Mrs. Claire P. Doblin.

TABLE OF CONTENTS

| | Page |
|---|-------|
| Preface..... | iii |
| Agenda..... | ix |
| List of Participants..... | xiii |
| List of Documents..... | xvii |
| Welcoming Address by Professor W. Häfele..... | xix |
| Welcoming Address by Professor W.D. Nordhaus..... | xxiii |

PAPERS PRESENTED AND DISCUSSED

| | |
|---|----|
| I. METHODOLOGY..... | 1 |
| An Econometric Approach to Forecasting the Market Potential of Electric Automobiles R.T. Crow and B. Ratchford..... | 3 |
| Discussion..... | 39 |
| Decreasing Block Pricing and the Residential Demand for Electricity L.D. Taylor..... | 43 |
| Discussion..... | 65 |
| Dynamic Energy Analysis as a Method for Predicting Energy Requirement M. Slesser..... | 68 |
| Discussion..... | 86 |
| Problems of Energy Demand Analysis P.S. Tsvetanov and W.D. Nordhaus..... | 89 |

| | |
|--|-----|
| II. INDIVIDUAL SECTORS | 103 |
| Electricity and Energy Savings in Industry | |
| J. Bouchet..... | 105 |
| Discussion..... | 115 |
| Prognoses of the Consumption of Energy, Especially | |
| Electricity: Methods and Experiences | |
| I. Lencz..... | 118 |
| Discussion..... | 138 |
| Effects of Increasing the Use of Electricity on | |
| Environmental Quality in the US: A Model of Power | |
| Generation and the Policy Issues Raised by Its | |
| Application | |
| T.D. Mount and L.D. Chapman..... | 140 |
| Discussion..... | 178 |
| An Application of the Concepts of Free and Captive | |
| Demand to the Estimating and Simulating of Energy | |
| Demand in Canada | |
| J.D. Khazzoom..... | 181 |
| Discussion..... | 233 |
| III. INDIVIDUAL ECONOMIES..... | 237 |
| 3.1 Eastern Europe and the USSR..... | 238 |
| Methods of Calculating Power Consumption in the USSR | |
| A.G. Vigdorichik and A.A. Makarov..... | 239 |
| Some Problems of Energy Demand in Poland | |
| J. Filipowicz and A. Klos..... | 255 |
| Planning the Energy Demand for the German | |
| Democratic Republic | |
| W. Hätscher..... | 260 |
| Discussion..... | 266 |
| 3.2 Western Europe..... | 277 |
| The Influence of Prices on the Consumption of Energy | |
| P. Morin..... | 278 |
| Energy Demand and Optimization of the Energy Choices | |
| D. Finon..... | 285 |

| | |
|--|-----|
| Paths of Energy Consumption for the Twenty-First Century J.R. Frisch..... | 318 |
| The Demand for Energy in Private Households in Austria G. Tintner and G. Wörgötter..... | 330 |
| Long-Term Tendency of Energy Demand and Supply in the Federal Republic of Germany F. Hoffmann..... | 335 |
| Discussion..... | 342 |
| 3.3 North America and Others..... | 344 |
| Residential, Commercial and Industrial Demand for Energy in Canada: Projections to 1985 with Three Alternative Models M. Fuss, R. Hyndman, and L. Waverman..... | 345 |
| Energy Demand Projection for Canada: An Integrated Approach F.W. Gorbet..... | 406 |
| The Demand for Energy Imports and Energy Independence D. Newlon..... | 445 |
| Discussion..... | 457 |
| India's Fuel Needs and Options K.S. Parikh..... | 459 |
| Discussion..... | 505 |
| IV. INTERNATIONAL STUDIES..... | 509 |
| The Demand for Energy: An International Perspective W.D. Nordhaus..... | 511 |
| Discussion..... | 588 |
| Energy Prospects in the Organization for Economic Cooperation and Development Area to 1985 R. Hamilton..... | 590 |
| International Comparisons of Energy Consumption Related to Gross National Product E. Medina..... | 646 |
| Discussion..... | 663 |
| Toward a Better Understanding of Energy Consumption J.-P. Charpentier..... | 665 |

| | |
|---|-----|
| V. LINKAGES TO THE REST OF THE ECONOMY..... | 709 |
| An Energy Forecasting Model for Sweden L. Bergman, A. Björklund, and K.-G. Mäler..... | 711 |
| Discussion..... | 722 |
| Introduction to the Methods Used in the World Modelling Project with Special Regard to the Energy Demand R. Bauerschmidt..... | 723 |
| Discussion..... | 737 |
| The Real Limits to Growth W.A. Ross..... | 740 |
| Discussion..... | 764 |
| Consumer Demand for Energy D.W. Jorgensen..... | 765 |
| Primary Energy Substitution Models: On the Interaction Between Energy and Society C. Marchetti..... | 803 |
| Discussion..... | 845 |
| VI. REVIEW AND DISCUSSIONS OVERVIEW..... | 847 |
| General Discussion and Overview..... | 849 |
| Summary and Overview of the Workshop W.D. Nordhaus..... | 853 |

AGENDA

Thursday, May 22

8:30 - 9:00 Registration (Schloss Laxenburg)

9:00 - 12:45 SESSION 1 (Chairman: W. Nordhaus)

9:00 - 9:15 Welcoming Addressess (W. Häfele and W.D. Nordhaus)

9:15 - 10:45 I. Methodology

R.T. Crow and B. Ratchford (USA), "An Econometric Approach to Forecasting the Market Potential of Electric Automobiles"

L.D. Taylor (Canada), "Decreasing Block Pricing and the Residential Demand for Electricity"

M. Slesser (UK), "Dynamic Energy Analysis as a Method for Predicting Energy Requirement"

P.S. Tsvetanov and W.D. Nordhaus (IIASA), "Problems of Energy Demand Analysis"

Discussion

11:15 - 12:45 II. Individual Sectors

J. Bouchet (France), "Electricity and Energy Savings in Industry"

I. Lencz (CSSR), "Prognoses of the Consumption of Energy, Especially Electricity: Methods and Experiences"

T.D. Mount and L.D. Chapman (USA), "Effects of Increasing the Use of Electricity on Environmental Quality in the US: A Model of Power Generation and the Policy Issues Raised by Its Application"

J.D. Khazzoom (Canada), "An Application of the
- Concepts of Free and Captive Demand to the
Estimating and Simulating of Energy Demand in
Canada"

Discussion

14:15 - 17:00 SESSION 2 (Honorary Chairman: Academician Styrikovic)

14:15 - 15:30 III. Individual Economies

3.1 Eastern Europe and the USSR

A.G. Vigdorichik and A.A. Makarov (USSR),
"Methods of Calculating Power Consumption in the
USSR" (Paper presented by Dr. Belostotski)

J. Filipowica and A. Kłos (Poland), "Some
Problems of Energy Demand in Poland" (Paper
presented by A. Kłos)

W. Hätscher (GDR), "Planning the Energy Demand
for the German Democratic Republic"

Discussion

3.2 Western Europe

P. Morin (France), "The Influence of Prices on
the Consumption of Energy"

D. Finon (France), "Energy Demand and Optimi-
zation of the Energy Choices"

15:45 - 17:00 Session 2 continued

J.R. Frisch (France), "Paths of Energy Con-
sumption for the Twenty-First Century"

G. Tintner and G. Wörgötter (Austria), "The
Demand for Energy in Private Households in
Austria"

F. Hoffmann (FRG), "Long-Term Tendency of Energy
Demand and Supply in the Federal Republic of
Germany"

Discussion

Friday, May 23

9:00 - 12:45 SESSION 3 (Chairman: W. Häfele)

9:00 - 10:15 3.3 North America and Others

M. Fuss, R. Hyndman, and L. Waverman (Canada),
"Residential, Commercial and Industrial Demand
for Energy in Canada: Projections to 1985
with Three Alternative Models"

F.W. Gorbet (Canada), "Energy Demand Projection
for Canada: An Integrated Approach"

D. Newlon (USA), "The Demand for Energy Imports
and Energy Independence"

Discussion

K.S. Parikh (India), "India's Fuel Needs and
Options"

Discussion

10:15 - 10:45 General Discussion of Studies of Individual
Economies

11:15 - 12:45 IV. International Studies

W.D. Nordhaus (IIASA), "The Demand for Energy:
An International Perspective"

R. Hamilton (OECD), "Energy Prospects in the
Organization for Economic Cooperation and
Development Area to 1985"

E. Medina (France), "International Comparisons
of Energy Consumption Related to Gross National
Product"

J.-P. Charpentier (IIASA), "Toward a Better
Understanding of Energy Consumption"

Discussion

14:15 - 17:00 SESSION 4 (Honorary Chairman: F. Rabar)

14:15 - 15:30 V. Linkages to the Rest of the Economy

L. Bergman, A. Björklund, and K.-G. Mäler
(Sweden), "An Energy Forecasting Model for
Sweden" (Paper presented by Mr. Mäler)

R. Bauerschmidt (FRG), "Introduction to Methods Used in the World Modelling Project with Special Regard to the Energy Demand"

W.A. Ross (Canada), "The Real Limits to Growth"

D.W. Jorgenson (USA), "Consumer Demand for Energy"

C. Marchetti (IIASA), "Primary Energy Substitution Models: On the Interaction Between Energy and Society"

Discussion

15:45 - 17:00 General Discussion and Overview

Summary and Overview of the Workshop

LIST OF PARTICIPANTS

Austria

Dr. H. Aubauer, Universität Wien
Dr. Deutsch, Institut für Ökonometrie, Wien
Dr. Schmoranz, Akademie der Wissenschaften
Prof. G. Tintner, Institut für Ökonometrie, Wien
Miss G. Wörgötter, Institut für Ökonometrie, Wien

Canada

Dr. R. Erdmann, Ministry of Energy, Mines and Resources
Mr. H. Flynn, Ministry of State for Science and Technology
Prof. J.D. Khazzoom, McGill University
Dr. W.A. Ross, University of Calgary
Dr. T.S. Tushak, Department of Energy, Mines and Resources
Prof. L. Waverman, University of Toronto

Czechoslovakia

Mr. I. Lencz, Power Research Institute

Federal Republic of Germany

Dipl. Ing. R. Bauerschmidt, Universität Hanover
Dr. F. Hoffmann, Ruhrkohle, Essen
Dr. H.-D. Schilling, Bergbau-Forschung GmbH, Essen

France

Dr. J. Bouchet, Electricité de France
Dr. B. Chateau, Institut Economique et Juridique de l'Energie,
Grenoble
Dr. J.R. Frisch, Electricité de France
Dr. B. Lapillonne, Institut Economique et Juridique de l'Energie,
Grenoble
Dr. E. Medina, Centre d'Etudes Regionales de l'Energie (CEREN)
Dr. P. Morin, Direction de la Prevision

India

Prof. K.S. Parikh, Indian Statistical Institute

Italy

Dr. H. Neu, Euratom, Ispra
Dr. R. Galli, Montedison

Japan

Dr. K. Hirota, Institute of Energy Economics
Dr. M. Takei, Institute of Energy Economics
Dr. H. Tominaga, University of Tokyo

Poland

Dr. J. Filipowicz, Ministry of Mining and Power
Prof. A. Kłos, Ministry of Mining and Power

Sweden

Prof. L. Bergman, Stockholm School of Economics
Prof. A. Björklund, Stockholm School of Economics
Dr. H. Flam, Stockholm School of Economics
Mr. M. Lönnroth, Delegation on Energy Policy
Prof. K.-G. Mäler, Stockholm School of Economics

USSR

Dr. Albegov, Academy of Sciences
Dr. Belostotski, Institute for High Temperatures
Acad. M. Styrikovich, Academy of Sciences

United Kingdom

Dr. F.W. Huther, Department of Energy
Dr. M. Slessor, University of Strathclyde, Glasgow

United States

Dr. R.T. Crow, EPRI, Palo Alto
Dr. T.D. Mount, Cornell University
Dr. D. Newlon, National Science Foundation
Dr. J. Schanz, Resources for the Future
Dr. J. Sweeney, Federal Energy Administration
Prof. L.D. Taylor, University of Arizona

OECD

Prof. R. Hamilton, University of Calgary

IAEA

Dr. G. Woite, Division of Nuclear Power and Reactors

IIASA

Prof. W. Häfele, IIASA Deputy Director, Energy Project Leader;
Karlsruhe Nuclear Research Center
Prof. W.D. Nordhaus, Chairman, Workshop on Energy Demand; Yale
University, New Haven, Connecticut

Dr. J.-P. Charpentier, Commissariat à l'Énergie Atomique, Paris

Mrs. C. Doblin, formerly United Nations, New York
Dr. W. Foell, Institute for Environmental Studies and College of
Engineering, University of Wisconsin
Dr. C. Marchetti, Euratom, Ispra, Italy
Dr. F. Rabar, INFELOR Systems Engineering Institute and Uni-
versity of Economics, Budapest
Dr. P.S. Tsvetanov, National Centre for Cybernetics, Sofia

LIST OF DOCUMENTS

- Bauerschmidt, R.
"Introduction to Methods Used in the World Modelling Project
with Special Regard to the Energy Demand"
- Bergman, L., A. Björklund, and K.-G. Måler
"An Energy Forecasting Model for Sweden"
- Bouchet, J.
"Electricity and Energy Savings in Industry"
- Charpentier, J.-P.
"Toward a Better Understanding of Energy Consumption"
- Crow, R.T. and B. Ratchford
"An Econometric Approach to Forecasting the Market
Potential of Electric Automobiles"
- Filipowicz, J. and A. Kłos
"Some Problems of Energy Demand in Poland"
- Finon, D.
"Energy Demand and Optimization of the Energy Choices"
- Frisch, J.R.
"Paths of Energy Consumption for the Twenty-First Century"
- Fuss, M., R. Hyndman, and L. Waverman
"Residential, Commercial and Industrial Demand for Energy
in Canada: Projections to 1985 with Three Alternative
Models"
- Gorbet, F.W.
"Energy Demand Projection for Canada: An Integrated
Approach"
- Hätscher, W.
"Planning the Energy Demand for the German Democratic
Republic"
- Hamilton, R.
"Energy Prospects in the Organization for Economic
Cooperation and Development Area to 1985"
- Hoffmann, F.
"Long-Term Tendency of Energy Demand and Supply in the
Federal Republic of Germany"

- Jorgenson, D.W.
"Consumer Demand for Energy"
- Khazzoom J.D.
"An Application of the Concepts of Free and Captive Demand to the Estimating and Simulating of Energy Demand in Canada"
- Lencz, I.
"Prognoses of the Consumption of Energy, Especially Electricity: Methods and Experiences"
- Marchetti, C.
"Primary Energy Substitution Models: On the Interaction Between Energy and Society"
- Medina, E.
"International Comparisons of Energy Consumption Related to Gross National Product"
- Morin, P.
"The Influence of Prices on the Consumption of Energy"
- Mount, T.D. and L.D. Chapman
"Effects of Increasing the Use of Electricity on Environmental Quality in the US: A Model of Power Generation and the Policy Issues Raised by Its Application"
- Newlon, D.
"The Demand for Energy Imports and Energy Independence"
- Nordhaus, W.D.
"The Demand for Energy: An International Perspective"
- Parikh, K.S.
"India's Fuel Needs and Options"
- Ross, W.A.
"The Real Limits to Growth"
- Slesser, M.
"Dynamic Energy Analysis as a Method for Predicting Energy Requirement"
- Taylor, L.D.
"Decreasing Block Pricing and the Residential Demand for Electricity"
- Tintner, G. and G. Wörgötter
"The Demand for Energy in Private Households in Austria"
- Tsvetanov, P. and W.D. Nordhaus
"Problems of Energy Demand Analysis"
- Vigdorichik, A.G. and A.A. Makarov
"Methods of Calculating Power Consumption in the USSR"

Welcoming Address By Professor W. Häfele

It is a great pleasure for me to welcome you. Some of you participated in our Workshop on Energy Resources and the methods for allocating these resources, but most of you have come specifically for the Workshop on Energy Demand and are at the institute for the first time. Therefore, I feel it appropriate to say a few words about IIASA to you.

I am addressing you in my capacity as Deputy Director of IIASA and I greet you also in the name of the Institute Director, Professor Raiffa. The idea for IIASA was conceived in 1966/1967 when it became increasingly evident that the imminent problems of large scale industrialization could be bigger than any problems civilization had so far experienced. At that time the United States wished to establish wider contacts with the Soviet Union, and a proposal was made to create an international study center to work on the problems of modern society created by the application of science and technology and the growth of industry. After years of negotiations, IIASA was founded at an Inaugural Conference held in London under the chairmanship of Lord Zuckerman in the fall of 1972.

The present membership of IIASA is made up of scientific National Member Organizations of fourteen countries with the USA and the USSR together assuming 55% of the Institute's financial responsibilities. The Institute's membership includes: Bulgaria, Canada, Czechoslovakia, France, the FRG, the GDR, Italy, Japan, Poland, and the UK, and two who joined later: Austria and Hungary. The idea is to gradually increase the Institute's membership rather than to form a closed club.

As to the nature of IIASA research, the scientists are essentially concerned with both the substantive physical dimensions of certain universal problems of civilization and the methodology of solving these problems through systems analysis.

There are currently eleven projects being pursued at IIASA, including the Water Project, the Energy Project, the Urban Project, the Ecology Project, and the Bio-Medical Project, the Large Industrial Organizations Project, the Integrated Industrial Systems Project, the State-of-the-Art Survey Project, the Computer Sciences Project, the General Activities Project, and the Methodology Project. Because of our emphasis on methods the Methodology Project is, so to speak, orthogonal to all the other activities.

Within the Energy Project--and here I speak as the Leader of the Energy Project--we first have to identify the kind of questions in the field of energy that we can pursue. We realize that there are a great number of energy studies being carried out in various nations, for example, Project Independence in the United States, and Project Sunshine in Japan to name only two. It is not the intention either of the Institute or of the Energy Project to duplicate these studies, and the result is that we are concentrating particularly on medium- and long-range aspects of problems attaining an increasing global importance. From this we have come to realize that there is a certain evolution in the energy problems to come. Within the next ten to fifteen years there definitely will be a supply shortage of fossil fuel, partly for physical reasons and partly for political reasons.

In the very long run, however, there will be more than one option for the infinite supply of primary energy. One therefore may say this future situation will be essentially the opposite of the present one. This brings us, then, to concentrate above all on the transition period. We are trying to understand what it means to go from the present oil-oriented situation to an all-coal society, an all-solar society, an all-nuclear society and maybe even an all-geothermal society, with the intention of identifying these options so that, in the final analysis, we may be in a position to assist decision makers in identifying optimal policy mixes.

The driving force for all these considerations is, of course, a better understanding of energy demand. In the 1960's trend extrapolation prevailed and only recently have we attempted to understand the interactions of detailed energy demand, on the one hand, and economic growth on the other hand. Demand forecasting can be done by various means and approaches: the econometric approach is one, the engineering approach is another. The question of energy demand is highlighted by the consideration of energy conservation which must be more or less fully understood, particularly for the near-term phase. We expect that this Workshop will lead to a greater clarification of these issues.

Please keep in mind that energy demand does not embrace the whole range of the energy problem, and that energy constitutes only one aspect of the Institute's activities. We are oriented toward methods and decisions, and we endeavor to identify the policy issues according to their priority.

This is Professor Nordhaus' Workshop. Professor Nordhaus is a well known economist from Yale University who is with us for a year. He and a few others in the Energy group have made it possible to hold this Workshop on Energy Demand.

Welcoming Address By Professor W.D. Nordhaus

It is a great pleasure to welcome you to IIASA for what is our second Workshop on Energy Systems, this one being on Energy Demand. We are delighted to have available leading experts from many countries, and we are especially delighted to have the chance to bring together the East and the West.

There are many conceptual problems I hope we can address in the next two days, and the studies prepared for the Workshop relate to most of the important questions. But I would remind our visitors, especially the holdovers from the Workshop on Energy Resources, that energy demand modelling is not based on rock-like foundations like energy supply and energy technology; rather energy demand is based on preferences and these have a kind of evanescent quality about them. I am convinced that energy demand work is really more an art than a science today.

I. METHODOLOGY

An Econometric Approach to Forecasting the
Market Potential of Electric Automobiles

Robert Thomas Crow and Brian Ratchford

I. Introduction

Among the effects of the rapid increase in petroleum prices and the Arab oil embargo of 1973-1974 has been a rash of recommendations on energy conservation and substitution of relatively abundant forms of energy for petroleum and natural gas. Many of these recommendations have come on the supply side--the development of solar energy, wind energy, oil shale, etc. However, it is suggestions on the demand side that will be our concern here.

Without question, many of the recommended innovations on the utilization of energy will prove to be ill conceived from the point of view of either technological feasibility or market acceptance. Unfortunately, virtually all of the discussion on innovations in utilizing energy has concentrated on feasibility and has ignored acceptability. This includes not only questions of price, but also questions concerning the quality of the product, its ease of use, etc. It is clear that in some instances the prices of innovations will prove to be economically unwarranted. That is, it will be deemed by users to be rational to pay a higher cost to use a product which--compared to a more energy-efficient alternative--is either less expensive in its initial purchase price, more reliable, or which delivers a stream of services of higher quality.

It must be recognized, however, that while it is relatively easy for skeptics to assert that the advocates of far-reaching

and radical, new technologies have lost contact with reality, it is equally easy to point to historic instances in which technology has outstripped the visions of all conventionally sane people. The fact that there is now a great inducement to technological change in energy-efficient usage technologies implies that those engaged in forecasting and planning in energy must attempt to take a close, systematic look at the implications of possible technological innovations.

We may regard new innovations as being of two types: 1) increased efficiency of existing technology, such as increased gas mileage in conventionally-powered automobiles; 2) significantly different technical principles, such as the electric automobile as a substitute for internal combustion automobiles. The implication here, of course, is that different technical principles may imply switching among sources of energy, which will in turn have serious implications for the size and composition of various segments of the energy industry. Our concern in this paper is with an innovation of the latter type--electric passenger automobiles.

In the case of the electric automobile, the switch away from gasoline is obvious. The implications for the electric utility industry are twofold: 1) implications concerning the total number of kilowatt hours sold, and 2) the shape of the load curve--that is, the periodicity of demand and the capacity utilization that it implies. Both the demand for kilowatt hours and the shape of the load curve have important implications for investment and research and development planning in the utility industry. For example, research and investment in base-load versus peak-load technologies are affected. This involves choices between base load systems, such as steam plants driven by fossil, nuclear or solar energy, and systems whose relative advantages are in meeting peak loads, such as gas turbines, pump storage, batteries or flywheels.

Thus, the objective of the present study is to forecast the market potential for electrical automobiles. In particular, we concentrate in this paper on forecasting shares of the total automobile market. It is clear that this is only a first step in assessing the impact of electrical automobiles on electric utility research and development priorities and investment planning. An equally important step would be to assess the likelihood that producers would meet the forecasted market potential--that is, the mysterious process of induced technical innovation, its timing, its success, and so on. In other words, in this study we only deal with the demand side of the market for electrical vehicles. The supply side, however, also promises to be extremely complex and uncertain. In addition, once the number and type of vehicles that would be on the market are determined, it is necessary to translate that information, via additional information on their usage, into kilowatt hour and load curve demands for the utilities. Thus, we have begun only one step of several in assessing the impact of electric automobiles on the utility industry itself.

The electric automobile problem that we deal with in this paper is a specific example of a general problem of forecasting the demand for a new technology in the household sector. Although our emphasis in this paper is couched in terms of the theory of household demand, we believe that similar analyses may also be appropriate for the demand for factors of production, but we have not yet investigated this area.

In dealing with the general problem of forecasting the demand for new goods, several problems arise which have received little attention in economic thinking. One is the very problem of describing a good itself. Of course, in many applications such a description is not of operational relevance.

However, when the problem concerns technological innovation, it is likely to become critical. Dennis Ironmonger [14] and Kelvin Lancaster [16] address this problem by specifying what has since become known as the "consumption technology" of a product.¹ This notion was also implicit in the work of Quandt and Baumol [18] and Baumol [2] when they specifically address the problem of forecasting the demand for new modes of intercity transportation and the impact of new modes of travel on the existing modes. In other words, Quandt and Baumol specified a demand system. We will take the same approach here.

A second problem is that, assuming one has developed a realistic consumption technology, it is then necessary to construct a demand model that not only adheres to that description, but which also follows sound analytical principles, among them being a test of reasonableness conditions on the forecasting characteristics of the model under conditions in which a new good is introduced. Also, it is desirable that such a model be consistent with optimizing behavior as specified by microeconomic principles.

Economists have, in general, ignored the problem of new goods except as a problem in the construction of price indices. Thus, there is little in the way of available literature upon which we can draw. However, as mentioned above, Quandt and Baumol--and others working with them--have addressed the problem of the introduction of a new good in an investigation of the demand for new modes of transportation in the Northeast

¹The simplest hypothesis for specifying a consumption technology is a linear hypothesis. This was the working assumption of both Lancaster and Ironmonger. However, it is not at all clear that consumption technologies, in fact, are linear.

Corridor region of the United States.² This has been the principle fountainhead of our own work and, in particular, the model that we use will be seen to be virtually identical to the specification used by Monsod. It should be pointed out, however, that until fairly recently the properties of these models were not well understood. Of them, only the Monsod model appears to have little or no trouble in meeting reasonableness conditions (see Crow, Young and Cooley [9]).

The work of Lancaster and Ironmonger cited above is of importance as a basic theoretical framework in which the demands for characteristics are the focus of attention and, thus, provides a starting place for a theoretical rather than ad hoc treatment for the demand for new goods. Also, in this connection, mention should be made of the work of Cowling and Rayner [6], Cowling and Cubbin [7] who have attempted to construct models of the demand for farm tractors and automobiles, but who have used a very different methodological approach, in that they used quality-adjusted price indices as arguments in their demand functions, rather than the characteristics of the technologies themselves. In other respects, as well, our specifications are quite different.

In the remainder of the paper, we will first present our demand model and its parentage. We then turn to a discussion of data and estimated results. Following this, we turn to simulations on the market potential of electric cars and their impacts on the market shares of other cars. Finally, we point out areas that we have identified as important for further research on assessing market potentials.

²See Crow, Young and Cooley [9] for a presentation of several of these approaches.

II. The Model

Our working assumption is that consumers react to goods as bundles of characteristics rather than to goods in their own right, i.e., there is an objective "consumption technology." There is, however, little reason to believe that the consumption technology must be linear, as specified by Lancaster and Ironmonger. In a recent paper, Crow (1975) suggested that X_{ij} , a quantity of differentiated good j (say electric autos) in good group i (say autos in general) could be defined as a number of repetitions (n_{ij}) of a particular bundle of characteristics, i.e., of the consumption technology of a unit of the good ij . Further, the consumption technology can be generally described as $Z_i f^{ij}$ (Z_{i1}, \dots, Z_{ir_i}), where Z_i is a "primary, immanent and unique" characteristic (PIUC) that defines whether or not a good ij is in fact a member of a good-group i (say, "owner-operated passenger transportation services") and $Z_{i1} \dots Z_{ir_i}$ are the secondary characteristics that vary among members of the good group (say, maximum rate of acceleration, head-room, etc.). Thus,

$$X_{ij} \stackrel{\text{defn}}{=} n_{ij} Z_i f^{ij}(Z_{ij1}, \dots, Z_{ijr_i}). \quad (1)$$

Assuming that the utility function is strongly separable in good groups,

$$U = F(U^1 + \dots + U^i + \dots + U^q), \quad (2)$$

where

$$U^i = U^i n_{i1} Z_i f^{i1}(Z_{i1}, \dots, Z_{ik}, \dots, Z_{ir_i}) \dots, \quad (3)$$

$$n_{is} Z_i f^{is}(Z_{i1}, \dots, Z_{ik}, \dots, Z_{ir_i})$$

where \underline{U}^i is the utility of good-group \underline{i} , which contains \underline{s} differentiated goods.³

The consumer optimization problem is straightforward.

Let,

$$V = U + \lambda \{ Y - \sum_i \sum_j p_{ij} n_{ij} z_i f^{ij}(z_{i1}, \dots, z_{ik}, \dots, z_{ir_i}) \} \quad (4)$$

optimizing over goods, for any given differentiated good $\underline{i} \underline{j}$

$$\frac{\partial V}{\partial n_{ij}} = \frac{\partial F}{\partial n_{ij}} - \lambda p_{ij} z_i f^{ij}(z_{ij1}, \dots, z_{ijk}, \dots, z_{ijr_i}) = 0 \quad (5)$$

and

$$\frac{\partial V}{\partial \lambda} = Y - \sum_i \sum_j p_{ij} n_{ij} z_i f^{ij}(z_{ij1}, \dots, z_{ijk}, \dots, z_{ijr_i}) = 0 \quad (6)$$

Assuming that expenditure for the good-group \underline{i} is given (which follows from strong separability), a complete system of demand equations for differentiated goods within the good-group may be defined. In this paper, we use the "relative shares" demand system of Monsod (1967).

This system can be shown to be consistent with Houthakker's [13] "direct addilog" utility function. For notational convenience, we drop $Z_i = 1$ and all \underline{i} subscripts (since we are dealing with only a single good-group) and assume the con-

³The assumption implied here is that consumers engage in multi-stage optimization. One stage might be a good-group, "passenger transportation services." A second might be a sub-group, "owner-operated passenger transportation services"--distinguished from other transportation sub-groups by owner-operatedness. A third stage might then be types of autos, etc.

sumption technology to be of form,

$$M_j = z_{j1} z_{j2} \dots z_{jr} \quad .$$

Weighting the characteristics by the satisfaction they confer,

$$S_j = z_{j1}^{\gamma_1} z_{j2}^{\gamma_2} \dots z_{jr}^{\gamma_r} \quad .$$

The direct addilog utility function may thus be written,

$$U = \alpha_1 (n_1 S_1)^{\beta_1} + \dots + \alpha_m (n_m S_m)^{\beta_m} \quad . \quad (7)$$

Following Houthakker [13], we take the first order conditions for repetitions (quantity) of any j, k pair of characteristics bundles and solve to yield a demand function of form:

$$\frac{\frac{y}{p_j}}{\frac{y}{p_k}} = \frac{\alpha_j \beta_j n_j^{\beta_j-1} s_j^{\beta_j}}{\alpha_k \beta_k n_k^{\beta_k-1} s_k^{\beta_k}} \quad . \quad (8)$$

If it is assumed that all information differentiating one member of the good-group from another is captured in the consumption technology, the utility weights (α 's and β 's) should be the same, i.e., representative of the good-group as a whole. Thus, the assumptions $\alpha_j = \alpha_k, \beta_j = \beta_k$ and $\gamma_{jr} = \gamma_{kr}$ simplify empirical application. Equation (8) may be rearranged and transformed as,

$$\begin{aligned} \log n_j - \log n_k &= \frac{1}{1-\beta} (\log p_j - \log p_k) \\ &+ \frac{\beta}{1-\beta} (\log s_j - \log s_k) \quad . \quad (9) \end{aligned}$$

This leads to Monsod's model,

$$\begin{aligned} \log n_j - \log n_k &= \alpha_j + \delta_0 (\log p_j - \log p_k) \\ &+ \delta_1 (\log Z_{j1} - \log Z_{k1}) + \delta_2 (\log Z_{j2} \\ &- \log Z_{k2}) + \dots + \delta_r (\log Z_{jr} - \log Z_{kr}), \quad (10) \end{aligned}$$

where the intercept, α_j , if statistically significant, is interpreted as a dummy variable representing the systematic influence of excluded variables differentiating j from k .

It should be pointed out that Monsod did not derive her "relative shares" model from these principles. Rather, her specification was based on the hypothesis that relative market shares depend on relative prices and relative values of characteristics, or

$$\frac{n_j/\Sigma n}{n_k/\Sigma n} = \frac{n_j}{n_k} = e^{\alpha_j} \left(\frac{p_j}{p_k}\right)^{\delta_0} \left(\frac{z_{j1}}{z_{k1}}\right)^{\delta_1}, \dots, \left(\frac{z_{jr}}{z_{kr}}\right)^{\delta_r}. \quad (11)$$

If $n_i/\Sigma n$ and $n_j/\Sigma n$ are interpreted as probabilities of purchases of n_i and n_j , then the structure of (10) is also similar to Thiel's [19] multinomial extension of the linear logit model. Furthermore, Thiel shows that the choice of indices j and k , etc. are arbitrary if "circularity" relations exist such that the δ 's are independent of j and k subscripts. Since this is the case with the Monsod model, we are warranted in expressing all j k ratios in terms of a given, arbitrary differentiated good b , called the "base" good.

Obviously, we have totally ignored problems of aggregation, thus relegating theory to the role of a paradigm suggesting reasonable restrictions on aggregate demand specifications. The importance of theory, however, should not be underestimated--particularly for problems concerning the introduction of new goods. Crow, Young and Cooley [9] found that plausibility conditions for the impact of the introduction of new goods on the demand for individual pre-existing differentiated goods, and on the demand for the entire good-group held only under particular parameter restrictions for some models (such as Monsod's) and not at all for others developed on apparently reasonable ad hoc grounds.⁴

One other problem connected with aggregation should be mentioned--namely, that the utility function as specified is continuously differentiable, whereas households purchase automobiles as discrete bundles. What we have specified here is behavior as though auto decisions took place in a rental market which reflected day-to-day variations in travel purposes. For example, a male family head may rent a compact for work trips, a station-wagon for a family vacation, a luxury car for an evening on the town with his wife, and a sports car for a day at the beach with his mistress. Thus, we have represented a demand for services that is assumed to approximate the distributions of weights of the utility function with respect to characteristics as they vary day-by-day over the life of the automobile. In other words, while individuals actually engage in putty-clay decision making in purchasing an asset that pro-

⁴ It should be mentioned that most of the restrictions to be satisfied are related to the demand for the good-group rather than the relative demands for differentiated groups. One exception is that market shares must always add to unity, which can be shown to hold for all relative demand specifications.

vides a stream of services, the demand function is more representative of the stream of services itself. We take this as a reasonable approximation to the demand for various differentiated autos.

III. Model Estimates and Data

In the first part of this section, we outline our approach to estimating functional relationships between the demand for automobile models and their characteristics. We then present alternative estimates of these relationships. To permit an evaluation of the practicality of our approach, we point out problems as well as suggest future refinements.

At least implicit in our analysis is an underlying model of consumer decision making which postulates that consumers go through a sequential decision process, the first stage of which is the decision to buy a new car. Given this decision, consumers are viewed as basing the choice between alternative cars on the relative attractiveness of the cars' attributes, according to the model outlined in the preceding section. In estimating the demand function, the objective characteristics used as independent variables should, to the extent possible, be directly related to consumer satisfaction. For example, weight is inappropriate because it is neither a desirable nor undesirable automobile characteristic in itself; however, leg room, ride, handling and acceleration are because they are directly related to consumer satisfaction.⁵

An additional consideration in estimating a function to be applied in forecasting the demand for electric autos is

⁵For evidence that including weight as a variable renders hedonic price index calculations for automobiles suspect see Triplett (1969).

that characteristics must apply to electric as well as current gasoline cars. This leads to some difficulties which cannot be completely overcome in this analysis. An example is that the ready availability of gasoline stations makes the range of current gasoline cars practically infinite, while lack of a quick and convenient method of recharging or exchanging batteries may severely limit the range of electric cars. Furthermore, it is unlikely that electric autos will be able to go much farther than 100 miles on a battery charge, while internal combustion autos typically travel well over 200 miles on a tank of gasoline.

In addition, while all current gasoline cars have the ability to cruise at highway speeds (fifty-five mph), this may not be the case for all electric cars. In both cases, since we have no way of directly estimating the effect of limited range or cruising speed on demand, our solutions for the potential market will assume that electric car technology improves to the point where electric cars are at least as good as the worst of the sample gasoline autos with respect to cruising speed and do not suffer from difficulties of charging or exchanging batteries or limitations on range between recharging or exchanging.

In defining the characteristics demand function, the quantity of any car j relative to that of any car b arbitrarily chosen as a base is assumed to depend on two types of characteristics:⁶ 1) physical attributes (including price) which vary across models; 2) characteristics which are specific to the manufacturer of model j , i.e., they are

⁶For a full discussion of the use of base modes in abstract mode models in transportation, see Crow, Young and Cooley [9].

more or less the same for each of the manufacturer's models, but vary across manufacturers. Examples of these latter characteristics are quality of dealer service, attractiveness of styling, reputation, etc. The demand function for car j relative to car b at time t might therefore be written, similar to (10) as:

$$\begin{aligned} \log (n_{jt}/n_{bt}) = & a + d_o \log(P_{jt}/P_{bt}) + d_1 \log \\ & (Z_{jit}/Z_{bit}) + \dots + d_r \log \\ & (Z_{jrt}/Z_{brt}) + c_1 M_1 + \dots + c_k M_{k-1} \end{aligned} \quad (12)$$

where

n_{jt} and n_{bt} are the quantities sold of automobiles j and b in year t ; P_{jt} and P_{bt} are prices in t , of j and b respectively; Z_{jit}, \dots, Z_{bit} are quantities of attributes $1, \dots, r$ in t for models j and b respectively; $M_1, \dots, M_j, \dots, M_k$ are dummy variables representing manufacturers $1, \dots, k$.⁷

The intercept has a rather special interpretation: it estimates the magnitude of preferences for all manufacturers k ($k \neq b$) relative to preferences for the base automobile; the base is therefore treated somewhat unsymmetrically in the model as, in effect, a separate manufacturer or as a model with a distinct identification within the manufacturer's offerings.

⁷If the "base" model is the only one produced by a given manufacturer, as is the case of Volkswagen in one of our samples, there will be $k - 1$ dummy variables.

Data to estimate the parameters of (12) were obtained for a total of 420 observations, 352 domestic and sixty-eight foreign, over the period 1960-73, with approximately thirty models in any given year. These 420 observations accounted for over 90% of domestic registrations during the period. Virtually the only models omitted (due to lack of data on characteristics) were the luxury Cadillac and Continental as well as certain specialty and imported autos whose sales were typically small.

For each car in the sample, the dependent variable was defined as domestic registrations for the corresponding calendar year as obtained from Automotive News Almanac. Aside from the manufacturer dummies, the following objective characteristics were employed as independent variables:

- 1) list price of middle-of-the-line four door sedan version of each model obtained from Automotive News Almanac;
- 2) front leg room, a proxy for front seat comfort, obtained from manufacturer's specifications published in Consumer Reports;
- 3) rear leg room, a proxy for rear seat comfort, obtained from Consumer Reports;
- 4) acceleration, number of seconds to go from zero to sixty mph, obtained from test results published in Consumer Reports;
- 5) passing speed, number of seconds to go from forty-five to sixty-five mph, an alternative measure of performance, obtained from test results in Consumer Reports;
- 6) average fuel consumption, in miles per gallon, for normal driving obtained from the Consumer Reports. This would be translated to "energy costs" in solutions to permit a direct comparison with electric automobiles;

- 7) an automatic transmission dummy variable, equalling 1 if automatic transmission is standard equipment, 0 otherwise.

Aside from price, the above attributes represent our attempt to obtain data on objective dimensions of comfort, performance and fuel economy. Other dimensions of comfort, performance and economy simply cannot be captured from existing data, but might be quite important to the choice of an automobile. Three of these dimensions are ride, handling and maintenance economy. As a somewhat crude attempt to quantify these dimensions, the Consumer Reports ratings of the following variables were quantified on a five point scale (assumed to have internal scale properties):⁸

- 8) ride, scaled excellent = 5, very good = 4, good = 3, fair = 2, poor = 1, fair-poor = 1.5 etc.;
- 9) handling, scaled as above;
- 10) frequency of repair, scaled much better than average = 5, better than average = 4, average = 3, worse than average = 2, much worse than average = 1.

The above represent the major automobile characteristics which we were able to quantify, a task which is fraught with many difficulties. For example, we could not come up with good quantitative estimates of braking performance for years prior to 1966 from Consumer Reports. In general, we observe

⁸Lancaster [17], Ch. 10, is a precedent for treating Consumer Reports ratings of individual attributes as objective data, although Lancaster inputes only ordinal scale properties to the ratings. In this study of automobile depreciation, Griliches and Ohta [12] also employ Consumer Reports ratings as internal scale data, though their scales differ slightly from ours.

that the Consumer Reports testing procedures and presentations of results seem much more thorough for recent years. Attempts to collect other test data from sources such as Car and Driver, Motor Trend, Popular Mechanics were abandoned when it became apparent that these tests were somewhat less exacting than Consumer Reports. There are, however, two variables which might be good proxies for luxury or comfort--length and width--for which we did not collect data, despite ready availability. This deficiency will be remedied in the near future. These data were not collected originally because it was thought that our attempt to collect data on characteristics more directly related to satisfaction would be sufficient. However, we eventually discovered that we could not get full sets of data on shoulder room and trunk capacity, two variables directly related to comfort and luxury. Another difficulty is that our measure of price is not completely satisfactory either conceptually or empirically. On empirical grounds we have the problem, shared in attempts to construct hedonic price indexes for automobiles (e.g., Griliches [11]; Dhrymes [10]) that transaction and list prices might differ radically. Because we are trying to study choice behavior for new cars, the device of using prices of one-year-old models (Chow [3]) is not a satisfactory alternative, although these prices might more closely reflect transaction prices after one year. To the extent that discounts off list price are greater on models that sell more, e.g., Chevrolet versus Buick, our price elasticity estimates will be biased toward zero.⁹

A second, more conceptual, difficulty is that the relevant price is not the purchase price of a new car, but the price

⁹Griliches and Ohta [12] present some indirect evidence that this might be the case (pp. 49-50).

of a flow of services from the car over a particular time period. But there will be a one-to-one relation between purchase price and price of service flow per unit time across all models only if depreciation rates are equal. To the extent that Volkswagen or Chevrolet models, for example, depreciate more slowly than other models, use of the purchase price overstates the actual price of using these cars relative to the price of using other models.¹⁰ Thus, purchase price is really a rough proxy for the relevant price of the service flow obtained from a given model.

Estimated Results

A priori, we hypothesize that front and rear leg room, ride, handling and repair frequency ratios, automatic transmission standard and gas mileage will be positively related to relative quantity, and that price, and the acceleration and passing speed variables will be negatively related (i.e., the longer it takes to accelerate to sixty mph and the longer it takes to reach passing speed, the more undesirable the car, all things being equal). Using all of the above variables, plus manufacturer dummy variables, representing each manufacturer except Chevrolet, Equation (12) was estimated for the combined 1960-1973 time-series and cross-section on which was comprised of 406 models--fourteen observations being eliminated by the "base" model. The "base" model was full-size Chevrolet; choosing this model as base in effect is equivalent to adding a separate dummy variable for this model in addition to the dummy for other Chevrolets. Since this model has far outsold other Chevrolet models over the 1960-

¹⁰Griliches and Ohta [12] present some evidence that Chevrolet models depreciate at a somewhat slower rate, but there does not appear to be a marked difference between manufacturers.

1973 period, and indeed has far outsold all models, this asymmetric treatment appears justified on empirical grounds; our results suggest that the full-size Chevrolet does have some special "drawing power."

Results for ordinary least squares regressions on the entire sample, both with and without manufacturer dummies, are presented in Table 1. Regressions 1 and 3 include all performance attributes, while Regressions 2 and 4 are our best results after non-significant variables and variables having a wrong sign a priori have been eliminated.

The first thing suggested by the results in Table 1 is that autonomous preferences for manufacturers explain considerably more of the variation in relative shares than performance attributes (at least those included in this study). Apparently manufacturer specific attributes such as quality of service, reputation, styling, advertising, image, etc., are important to car buyers. Even including the manufacturer dummies, however, we are able to capture only 50% of the variation in the relative shares. Possibly this is owing to: 1) The fact that the manufacturer dummies are unable to capture the full amount of loyalty to various models rather than manufacturers; 2) the possibility that the relevant functions are unstable either through time or over various car size classes. The first problem might be remedied by including lagged model shares in independent variables, with the lag possibly carrying over for several time periods to reflect the time between trade-ins. Some tests will be undertaken in the future to investigate the second problem.

The intercept in Regressions 1 and 2 indicates the relative preference for full-sized Chevrolets over other Chevrolets, holding performance attributes constant; e.g., holding attributes constant, $\log n$ for the full size Chevrolets less $\log n$ for other Chevrolets = .71232, which is quite substantial. The

Table 1. Regressions of $\log(n_{jt}/n_{bt})^*$ on attributes and manufacturer dummies, entire sample (T-ratios in parentheses).

| VARIABLE | 1 | 2 | 3 | 4 |
|---|------------------------|------------------------|------------------------|------------------------|
| Log (Price _{jt} /Price _{bt}) | -1.59135 (-5.57153) | -1.48255 (-6.37429) | -1.93575 (-5.46099) | -1.09113 (-3.57367) |
| Log (Ft leg rm _{jt} /Ft leg rm _{bt}) | 1.44168 (2.01250) | .99371 (1.47672) | 1.88118 (2.01268) | 1.01984 (1.11693) |
| Log (Rear leg rm _{jt} /Rear leg rm _{bt}) | .93867 (2.34161) | .91369 (2.34572) | .38395 (.76344) | 1.08452 (2.21140) |
| Log (Accel _{jt} /Accel _{bt}) | .12246 (.37086) | | .57793 (1.33941) | |
| Log (Pass _{jt} /Pass _{bt}) | -2.29993 (-1.22521) | -.27475 (-2.07688) | -.16998 (-.54252) | -.12466 (-.74457) |
| Log (Ride _{jt} /Ride _{bt}) | -.10485 (-1.39175) | | -.05111 (-.53493) | |
| Log (Hand _{jt} /Hand _{bt}) | .29709 (2.58643) | .32608 (2.89123) | .18941 (1.33374) | .26207 (1.78574) |
| Log (Repr Freq _{jt} /Repr Freq _{bt}) | -.04341 (-.58666) | | -.00724 (-.07694) | |
| Log (Gas Mi _{jt} /Gas Mi _{bt}) | -.34507 (-1.16659) | | -1.70803 (-5.76013) | |
| Auto Trans Std = 1 | .10313 (1.86788) | .10115 (1.85003) | .08826 (1.21957) | .06225 (.83673) |
| Ford = 1 ⁺ | .16997 (2.84414) | .16205 (2.75599) | | |
| Chrysler = 1 | -.26431 (-4.75013) | -.28608 (-5.25786) | | |
| AMC = 1 | -.56108 (-8.98396) | -.56471 (-9.13973) | | |
| Other Ford = 1 [§] | -.35009 (-5.41916) | -.35979 (-5.60989) | | |
| Other GM = 1 [#] | -.12661 (-2.25297) | -.13359 (-2.40012) | | |
| Volkswagen = 1 | .17261 (1.71681) | .14012 (1.50373) | | |
| Other Import = 1 | -.59149 (-7.77848) | -.64364 (-10.46807) | | |
| Intercept | -.71232 | -.70962 | -.88856 | |
| N | 406 | 406 | 406 | 406 |
| R ² | .503 | .497 | .1232 | .0449 |
| Std. Error | .26565 | .26584 | .34955 | .36299 |

*The term n_{jt}/n_{bt} represents number of units of model j registered in year t relative to number of units of model b registered in t. In this analysis, the "base" model was the full-sized Chevrolet. Common logarithms are used throughout.

⁺Refers to cars carrying the "Ford" brand.

[§]Refers to Lincoln and Mercury.

[#]Refers to GM brands other than Chevrolet; models of Chevrolet other than the full-size model are included in the intercept.

full-size Chevrolet, Ford, and Volkswagen exceed other Chevrolets in "brand preference" (the coefficients of these Ford and VW dummies are .16997 and .17261 in Regression 1; .16025, and .14012 in Regression 2). Regressions 1 and 2 also indicate a strong aversion to Chrysler, AMC and "other" imports. The obvious implication is that an electric (or any other car) would have a much greater chance of succeeding on the market if it were made by Ford, Chevrolet, or Volkswagen than if it were made by Chrysler, AMC, some non-VW importer, or some relatively unknown manufacturer. Especially since many of the firms presently working on development of electric cars are not currently auto manufacturers, this is an important finding.

In Regression 1, the coefficients of acceleration, ride repair frequency and gas mileage all have the wrong sign. The statistical insignificance and negative sign on gas mileage were particularly noteworthy because fuel costs constitute a major part of the cost of operating an automobile, and it seems unrealistic to suppose that, all things equal, better gas mileage would not be a desirable attribute.¹¹ Unfortunately, the negative sign on this variable persisted throughout the statistical tests with virtually every possible combination of independent variables. Our tentative explanation is that this variable is probably correlated negatively with variables representing luxury performance which are left out of our analysis. Thus, in Regression 1, low gas mileage may

¹¹The negative sign on repair frequency is not quite so distressing because this variable is, at best, a crude measure of maintenance costs and because maintenance costs appear to be a relatively small part of the cost of spending on an automobile. See, for example, US, Department of Transport. Cost of Operating an Automobile [20].

be acting as a proxy variable for luxury. Possibly adding attributes such as length and width to the analysis would yield results which would be acceptable a priori and yield some level of statistical significance.

Regression 2, which was obtained after repeated experiments with different variables, represents our most plausible equation to be used in forecasting. All attribute coefficients have the expected sign, and all t ratios exceed one. The implied elasticity of relative quantity with respect to relative price is, as in Regression 1, around 1.5, and is highly significant. The equation also suggests that other attributes which affect the choice of automobile models are front and rear leg room (proxies for comfortable accommodations), passing speed (which was highly correlated with the omitted acceleration variable), handling, and whether and automatic transmission is standard equipment. The coefficients of all these change very little from Regression 1, and the value of R^2 is only slightly lower.

Regressions 3 and 4 are the counterparts of 1 and 2, except that the manufacturer dummies are dropped. The coefficients of determination drop markedly (both regressions are still statistically significant at the .01 level), but the coefficients of the various attributes remain fairly similar; apparently the manufacturer effects are substantially independent of the levels of the various attributes. The acceleration, ride, repair frequency, and gas mileage variables still have the wrong sign in Regression 3, and the most notable difference between Regressions 2 and 4 is that the coefficient of price is closer to zero in the latter equation.

While the results in Table 1 were obtained for all automobile models, the electric cars currently under development apparently will be relatively small vehicles designed mainly for commuting and intra-city use. In actual use they will

undoubtedly resemble and compete most closely with models of the type currently designated as "subcompacts." Therefore, an important question is whether the determinants of demand for subcompacts differ from those for other automobiles. Because subcompacts perform different functions as second autos, this might be the case. Therefore it is appropriate to test for differences in demand relationships for subcompacts compared to other autos. To test, we applied the standard procedure of breaking our sample into two subsamples, sixty-six subcompacts and 340 others, and running separate regressions on each. For Regressions 1 and 2 respectively, "Chow" tests of the null hypothesis that the coefficient vectors are equal between the two subsamples gave, respectively, $F = 3.23$ for fourteen and 374 degrees of freedom and $F = 3.93$ for ten and 382 degrees of freedom.¹² Both results are significant at the .01 level suggesting that there is a difference in determinants of demand between subcompact and other cars. However, since this test is quite powerful for samples as large as ours, and since the standard error of the pooled regressions in Table 1 are not appreciably larger than those in the individual regressions, we feel that the real differences between samples may be relatively small and the results in Table 1 still merit consideration.¹³

¹²The "Chow" test is $F = [(A - B)/d.f._A - B] / [B/d.f._B]$, where A = sum of squared residuals for the pooled regression, B = sum of squared residuals for each individual regression summed across both regressions, $d.f._A$ = residual degrees of freedom for the pooled regression, $d.f._B$ = the sum of residual degrees of freedom for the individual regressions. See, for example, Johnston [15], subcompact sample.

¹³For example, Griliches and Ohta [12] argue on grounds of parsimony in favor of a methodology which employs constrained (pooled) regressions if their standard errors are not appreciably larger than those of unconstrained regressions even though formal F -tests might reject simplifying hypotheses embodied in the constrained regressions.

Because of the suspected difference, however, the relative shares model was also estimated on the subsample of compacts. Since the full-size Chevrolet is not in this class, it is no longer appropriate to use it as base; therefore, the Volkswagen "Beetle" (the only VW in our sample) was used as base in this analysis. Elimination of the fourteen VW observations from the original sixty-six left fifty-two observations on subcompact registrations and attributes relative to VW.

The results of the analysis, which are presented in Table 2, differ from those in Table 1. There is somewhat less variation in the manufacturer coefficients, although AMC (included in the intercept) again appears to be at a relative disadvantage. Not surprisingly, the large negative intercept indicates that Volkswagen, appears to be the "most preferred" brand. Also, the coefficient of price is consistently larger (more negative) than in Table 1; this may be owing in part to the fact that small cars are discounted less, and that the estimates on Table 2 simply provide better estimates of the price elasticity of demand for all cars with respect to transaction prices. Another possibility is that buyers of subcompacts are a distinct market segment which is markedly more sensitive to price than the auto buying population as a whole.

There are also differences in the coefficients that appear to be important. Now front leg room, acceleration (as in Table 1), ride, handling, and gas mileage have the wrong signs and are insignificant.¹⁴ As in Table 1, the negative sign on gas mileage failed to disappear through repeated experiments even though fuel economy is presumably an important attribute of subcompacts. In this case, this

¹⁴There is no automatic transmission variable since none of the cars in this subsample had an automatic transmission.

Table 2. Regressions of $\log(n_{jt}/n_{bt})^*$ on attributes and manufacturer dummies; subcompacts only (T-ratios in parentheses).

| VARIABLE | 1 | 2 | 3 | 4 |
|---|------------------------|------------------------|------------------------|------------------------|
| Log (Price _{jt} / Price _{bt}) | -3.44702 (-2.52366) | -2.80909 (-2.76754) | -3.44793 (-3.36809) | -3.97632 (-3.73079) |
| Log (Ft leg m _{jt} / Ft leg m _{bt}) | -1.99894 (-.40602) | | | -3.09390 (-.64635) |
| Log (Rear leg m _{jt} / Rear leg m _{bt}) | .52941 (.37458) | | | 2.26800 (1.74278) |
| Log (Accel _{jt} / Accel _{bt}) | .23584 (.10665) | | | 3.02542 (1.47166) |
| Log (Pass _{jt} / Pass _{bt}) | -1.06836 (-.75031) | -1.04964 (-2.20059) | -.99974 (-1.93362) | -2.50821 (-1.89293) |
| Log (Ride _{jt} / Ride _{bt}) | -.10858 (-.39332) | | | -.38164 (-1.39081) |
| Log (Hand _{jt} / Hand _{bt}) | -.27498 (-.53138) | | | -.07730 (-.14648) |
| Log (Repr freq _{jt} / Repr freq _{bt}) | .29066 (.95552) | .25724 (.96640) | .29247 (.94241) | .31275 (.96493) |
| Log (Gas mi _{jt} / Gas mi _{bt}) | -.97391 (-.96461) | | | -1.49832 (-1.95287) |
| Fort = 1 | .62433 (2.22029) | .69903 (3.14126) | | |
| Other Ford = 1 | .48178 (1.14737) | .57971 (1.67498) | | |
| AMC = 1 | .25347 (1.12342) | .16096 (1.00729) | | |
| Chevrolet = 1 | .74582 (3.04895) | .74354 (3.65876) | | |
| Intercept | -1.06945 | -1.04291 | -.77980 | -.83479 |
| N | 52 | 52 | 52 | 52 |
| R ² | .525 | .505 | .213 | .395 |
| Std. Error | .30865 | .29279 | .35349 | .33140 |

*The term n_{jt}/n_{bt} represents number of units of model j registered in year t relative to number of units of model b registered in t, where the "base" model b was the Volkswagen "Beetle." Common logarithms are used throughout.

perverse result is very difficult to explain.

In the process of developing a regression for forecasting purposes, the rear leg room variable was dropped because it had the wrong sign, and handling, ride and acceleration were also insignificant. The best regression in Table 2, presented as Regression 2, suggests that elasticity with respect to relative price is about 2.8, and that passing speed and possible repair frequency are other attributes which influence choice. The latter was included in our final equation even though its t ratio was slightly below our usual rule-of-thumb cutoff point of one.

As in Table 1, Regressions 3 and 4 in Table 2 are the counterparts of Regressions 1 and 2 in Table 1. Again, the coefficients are reasonably similar to those in Regressions 1 and 2, but, unlike Table 1, the coefficients of determination do not drop as drastically when the manufacturer variables are eliminated. This suggests that brand preferences may not be as dominant an influence on demand in the subcompact market as they appear to be in the rest of the automobile market.

In general, the results presented in this section suggest that price, performance and particularly the manufacturer's identity are important determinants of the relative shares of new cars. The results could probably be improved in several respects, and we will work on these in the future. First, we have not tested for changes in the demand functions over time; in the future we plan to apply a modification of the Cooley-Prescott [5] adaptive forecasting procedure in an attempt to track changes and to develop an optimal weighting of current versus past observation. Second, as mentioned earlier, we have not yet considered time lags in the determination of model shares. Finally, we will investigate the influence of variables omitted thus far, such as overall body length and width.

IV. Solutions for the Market Potential of Electric Automobiles

The equation estimates shown in Tables 1 and 2 will not be used to solve for the market potential of electric automobiles under sets of assumptions that reflect realistic expectations on the price and standards of performance of such vehicles. In order to convert the ratio of some vehicle J to the base vehicle into shares of the total market, let the numerators and denominators of equations be considered as n_j and n_b respectively. Thus, from our estimated equations we have the following:

$$\frac{n_1}{n_b} + \dots + \frac{n_j}{n_b} + \dots + \frac{n_m}{n_b} = \frac{\sum_{j=1}^m n_j, j \in m}{n_b} . \quad (13)$$

Dividing both sides of (13) by $\sum_{j=1}^m n_j/n_b$, yields the basic market share identity,

$$\frac{\frac{n_1}{n_b}}{\sum_{j=1}^m \frac{n_j}{n_b}} + \dots + \frac{\frac{n_j}{n_b}}{\sum_{j=1}^m \frac{n_j}{n_b}} + \dots + \frac{\frac{n_m}{n_b}}{\sum_{j=1}^m \frac{n_j}{n_b}} = 1 . \quad (14)$$

That is, the market shares must sum to unity with the terms on the left hand side equaling the market shares of the individual models.

Since it is clear that Regression 2 in Table 1 and Regression 2 in Table 2 are superior to any of the alternatives, they alone will be used for solution purposes. It will be recalled that Table 1 is a representation of market shares for all cars while Table 2 represents market shares for sub-compacts only. In both cases, for purposes of calculating market shares, the other cars in the solution are 1973 models. Thus, in effect, what we are doing is estimating the market share for electrical automobiles had such automobiles been easily available in 1973.

We develop solutions for four hypothetical electric cars embodying two different sets of physical attributes, plus two assumptions about the identity of the manufacturer. One set of characteristics we may regard as the "near-term" set, representing an electric auto that could be brought onto the market currently or in the near future. The second set of characteristics we may regard as the medium-term set, embodying performance of an electric automobile which is more advanced but in some senses still inferior to current subcompacts. Over the long term it might be possible that electrical automobiles will be developed to an extent that they will be competitive in every respect with existing internal combustion automobiles for normal road and driving conditions. We have not simulated this latter case since it would do no more than repeat the market shares of existing automobiles. Thus, we only test the near-term and medium-term sets of physical attributes.

With respect to manufacturers, for each of the sets of physical assumptions, we make alternate assumptions: 1) the manufacturer is new to the industry, i.e., the manufacturing effect is assumed to be neutral and thus the dummy variable for automobile make is set at zero; and 2) the electric auto is made by a large domestic manufacturer, assumed to be Chevrolet. Results, of course, would be somewhat similar had the domestic manufacturer been assumed to be Ford. The physical characteristics of the near-term electric automobile are as follows:

- a) it carries a relatively low list price--approximately \$2,700;
- b) it has average front leg room for a subcompact;
- c) it has no rear seat; hence, we arbitrarily set the

- rear leg room equal to one inch;¹⁵
- d) the car will take forty seconds to go from zero to sixty mph. This is very slow--approximately double that of the worst of the current subcompacts. However, it seems to be a realistic, perhaps even optimistic, assumption from what we have learned about electric autos that can be or are on the market presently;
 - e) it will take approximately thirty-two seconds to go from forty-five mph to sixty-five mph as a representation of passing speeds. This, too, is a somewhat optimistic assessment;
 - f) the handling rating has been set equal to 3, that is, we expect handling to be average; and
 - g) we assess repair frequency to be equal to 5, that is, superior repair frequency performance since electric cars have very few moving parts and would presumably need repair much less frequently.

The assumed physical characteristics of the medium-term electric car are based on the optimistic end of what developers are aiming to produce--given current battery, electronic, and other relevant technology. They are as follows:

- 1) price would be expected to be around \$4,000;
- 2) front leg room is assumed to be approximately the same as average current subcompacts, that is, forty inches;

¹⁵This is a highly arbitrary treatment. It was necessary because none of the compacts in our sample lacked rear seats. Had we been able to do it, it would have been better to have represented the presence or absence of a rear seat by a dummy variable. Arbitrarily setting the rear seat value so low may have an unwarranted depressing effect on the market share.

- 3) rear leg room is assumed to be equal to that of the average subcompact or twenty-three inches;
- 4) acceleration of zero to sixty mph is expected to be about thirty seconds;
- 5) it is expected that it would take approximately twenty-four seconds to go from forty-five mph to sixty-five mph.¹⁶
- 6) handling rating is again expected to be average, or a ranking of 3; and
- 7) repair frequency is assumed to be superior, and thus has a ranking of 5.

Given these assumptions, Table 3 indicates the solutions for the market share of electric automobiles and total number of sales that might have been expected in 1973 had the electric automobiles been freely available on the market. In the case of the near-term electric automobile, the solutions indicate that if this vehicle were brought to the market by a new manufacturer, it would sell a rather minuscule .03% of the total 1973 market or 2,400 units. On the other hand, were it marketed by Chevrolet, it would apparently have had sales

Table 3. Solutions for the 1973 potential market share and total sales of electric automobiles, based on regression 2, Table 1.

| Automobile | Maker | Market Share | Total Unit Sales in 1973 Sample (thousands) | Potential Electric Auto Sales in 1973 (thousands) |
|---------------------------|-------|--------------|---|---|
| Near-Term Electric Auto | New | .0003 | 9,600 | 2.4 |
| | Chev. | .0012 | 9,600 | 11.7 |
| Medium-Term Electric Auto | New | .0029 | 9,600 | 28.1 |
| | Chev. | .0128 | 9,600 | 122.8 |

¹⁶These latter two assumptions place the performance of the medium-term electric automobile at approximately the same level as a 1960 Volkswagen.

of approximately .1% or roughly 11,700 units. Even though the medium-term electric automobile would appear to be considerably more expensive, the market shares are much higher--approximately .3% or 28,000 units in the case of the new manufacturer or 1.3% or 122,800 units in the case of Chevrolet.

Table 4 shows solutions of a two-step procedure in which we first calculate the 1973 share of the electric car relative to all subcompacts and then the share that the subcompacts had of the 1973 market, approximately 25%. The results in this case are strikingly different. The near-term car with a new manufacturer has approximately 1% of the subcompact market, or 0.2% of the total market, which translates to approximately 24,000 units. If the near-term electric car is marketed by Chevrolet, it would have had approximately 5% of the subcompact market, or 1.3% of the total market, translating to approximately 125,000 units. These results are higher by a

Table 4. Solutions for the 1973 potential market share and total sales of electric automobiles, based on regression 2, Table 1.

| Automobile | Maker | Share of Sub-Compact Market | Subcompact of Total Market | Total Unit Sales in 1973 Sample (thousands) | Potential Electric Auto Sales in 1973 (thousands) |
|---------------------------|-------|-----------------------------|----------------------------|---|---|
| Near-Term Electric Auto | New | .0099 | .248 | 9,600 | 23.6 |
| | Chev. | .0527 | .248 | 9,600 | 125.4 |
| Medium-Term Electric Auto | New | .0045 | .248 | 9,600 | 10.7 |
| | Chev. | .0243 | .248 | 9,600 | 57.9 |

factor of ten than those of Table 3 where the sample was all automobiles rather than subcompacts alone.

Results for the medium-term car are scarcely less surprising. The share of the subcompact market for the medium-term car is less than .5%, or 0.1% of the total market, which would be approximately 11,000 units. If it is marketed by Chevrolet, it is approximately 2% of the subcompact market, 0.6% of the total market, or approximately 58,000 units. These figures contrast sharply to those of Table 3, being less than half of what Table 3 implied.

One reason for these discrepancies in the results is that when the subcompacts are broken out as a separate sample, the near-term car compares much better because rear leg room is not a significant variable in the market for subcompacts. Furthermore, the market for subcompacts is much more sensitive to price than the market for automobiles as a whole--the relative price elasticity is roughly double that for the market as a whole. This imposes a heavy penalty on the medium-term electric automobile which is considerably more expensive than the near-term automobile or the average price of current subcompacts.

As a point of reference on the sales figures, average sales per model in 1973 was 223,000 units. Of course, there is a great deal of variation about this figure, and we do not have a clear idea of what the critical number is at which point a model becomes profitable to put on the market. Of critical importance here, as reflected in the regression, is the importance of being marketed by a known manufacturer. As discussed above, there are many reasons why this may be true, such as the size of the dealer network for servicing, advertising expenditures, the persistence of habits, and the existence of other unincorporated variables which bear a strong relationship to brand name identification.

V. Summary, Caveats, and Directions for Further Research

We have attempted in this paper to develop and apply an approach to forecasting the demand for new goods. While we have made some progress, it is obvious that a great deal should be done before using this approach in a serious application. There are three areas in which we plan to begin work immediately.

One is investigation of dynamic specifications of the market shares mode. We think it is reasonable to postulate that habit formation is an important determinant of automobile buying behavior and we will begin to develop dynamic specifications to be tested. Since we have used pooled cross-section and time series data, we will pay particular attention to econometric problems associated with dynamic specifications with this type of sample. It would appear to be appropriate to use estimators such as the Balestra-Nerlove [1] error components approach for this purpose.

A second task is to investigate cross-section results over time for possible changes in the parameters to see if they vary significantly and systematically. If they do, we will attempt to account for such changes. Also, for forecasting applications, it can reasonably be assumed that the most recent observations are the most relevant for the future and, therefore, we plan to explore the Cooley-Prescott adaptive forecasting estimator to take this into account. Third, we have indicated that we believe that automobile length and width may be important omitted variables relating to comfort and luxury. We plan to investigate what, if any, effect these may have on our results.

Other directions of research that would appear to be profitably pursued would be to investigate the implications of alternative utility functions and consumption technologies. In the

case of both the addilog utility function and the multiplicative consumption technology, our choice was based on essentially arbitrary grounds. Translog, constant elasticity of substitution or other utility functions might equally well have been selected. Also, it would appear that the entire range of issues surrounding the selection of a consumption technology is a realm for fruitful investigation. There would appear to be no particular reason why either a linear or a multiplicative consumption technology should be assumed. Rather, it seems to us, that a proper specification of a consumption technology will differ from good to good, perhaps resulting in rather complicated formulations of multiplicative and additive terms depending on the way various characteristics yield satisfaction to consumers.

Our biggest problem with data, other than the general question of intangible characteristics, would seem to be that we have not been able to develop data on the variation within models. For full-size Chevrolets, for example, there are several engine sizes with associated differences in performance characteristics, choices of two-door, four door, or stationwagon models, not to mention choices on the quality of interior and exterior appointments and trim. This leads to the entire question of style and aesthetics, which we have not been able to address at all. From casual observation, we would have to believe that aesthetic appeal varies a great deal from year to year and between models and manufacturers. We have no particular insights on how to handle the style and aesthetics question other than perhaps to investigate year- and model-specific dummy variables and simply see what happens. This is obviously not an intellectually satisfactory approach to this problem. However, if it removes some of the noise from our sample and helps to make heretofore nonsignificant variables significant, the benefits in precision may outweigh the costs of conceptual weakness. We are particularly disturbed by what

we regard as a lack of credibility of our results concerning the insignificance of gasoline mileage as an element of consumer choice. We would think, if for no other reason, that the amount of advertising expenditure that has been devoted to this characteristic would make it statistically significant.

While it is clear that there is a great deal more to be done in looking at the problems of electric automobiles within this analytical framework, we feel that we have accomplished several significant tasks: 1) an explicit derivation of a demand function for a particular new good; 2) estimating of the parameters of this function; and 3) solutions for what appear to be reasonable technological possibilities for electric automobiles.

In particular, our findings indicate that purchase price is likely to be a significant determinant. This, of course, is hardly surprising. Of greater interest is the finding of a strong influence of "brand name identification." We have identified several areas that might account for this phenomenon such as the size of a dealer network, styling, quality of service, advertising expenditures, and others. However, these factors are currently locked into dummy variables and remain only items of speculation. Nevertheless, while we do not know what accounts for the importance of the manufacturers dummy variables, it is clear that they are important and must be reckoned with in considering the viability of any future electric automobile.

It is also apparent, but not particularly surprising, that the elapsed time of accelerating from forty-five mph to sixty-five mph is an important variable. Nowhere in the world, to our knowledge, are motorists insensitive to speed

and acceleration. We found, also, in the estimates presented in Table 1 that front and rear leg room are of some importance. However, this result was not confirmed in the subcompact sample whose results are presented in Table 2.

In short, we cannot pretend that our findings regarding the future of electric automobiles are definitive, but we do hope that they lead to increased research in not only the area of the market potential of new automobiles, but on new goods in general--an area that, with a few notable exceptions such as Lancaster [16], Ironmonger [14], Quandt and Baumol [18] and Baumol [2] has been relatively neglected.

References

- [1] Balestra, P., and Nerlove, M. "Pooling Cross-Section and Time Series Data in the Estimation of a Dynamic Model: The Demand for Natural Gas." Econometrica, 34 (1966), 585-612.
- [2] Baumol, W.J. "Calculation of Optimal Product and Retailer Characteristics: The Abstract Mode Approach," Journal of Political Economy, 75 (1967), 674-685.
- [3] Chow, G. Demand for Automobiles in the United States. Amsterdam, North Holland, 1957.
- [4] Collas-Monsod, S. "Further Development of the Cross-Sectional Rail Passenger Demand Model." In Mathematica, Studies in Travel Demand, Vol. 3, Springfield, Virginia, Clearinghouse for Federal Scientific and Technical Information, 1967, pp. 66-95.
- [5] Cooley, T., and Prescott, E. "Systematic (Non-Random) Variation Models Varying Parameter Regressions: A Theory and Some Application." Annals of Economic and Social Measurement (1973), 463-473.
- [6] Cowling, K., and Rayner, A.J. "Price, Quality and Market Share." Journal of Political Economy, 78 (1970), 1291-1309.

- [7] Cowling, T., and Cubbin, I. "Price Quality and Advertising Competition: An Econometric Investigation of the U.K. Car Market." Economic Journal, 38 (1971), 378-394.
- [8] Crow, R.T., "On the Demand for New Goods." Unpublished (March 1975).
- [9] Crow, R.T., Young, K.H., and Cooley, T. "Alternative Demand Functions for 'Abstract' Transportation Modes." Transportation Research, 7 (1973), 335-354.
- [10] Dhrymes, P. "On the Measurement of Price and Quality Changes in Some Consumer Capital Goods." American Economic Review, 57 (1967), 511-518.
- [11] Griliches, Y. "Hedonic Price Indexes for Automobiles: An Econometric Analysis of Policy Change," The Price Statistics of the Federal Government. New York, National Bureau of Economic Research, pp. 137-196.
- [12] Griliches, Z., and Ohta, M. "Automobile Prices Revisited: Extensions of the Hedonic Hypothesis." Discussion Paper No. 235, Cambridge, Massachusetts, Harvard Institute of Economic Research, 1973.
- [13] Houthakker, H. "Additive Preferences." Econometrica, 28 (1960), 244-257.
- [14] Ironmonger, D.K. New Commodities and Consumer Behavior. London, Cambridge University Press, 1972.
- [15] Johnston, J. Econometric Methods. Second edition. New York, McGraw-Hill, 1972.
- [16] Lancaster, K. "A New Approach to Consumer Theory." Journal of Political Economy, 74 (1966), 132-157.
- [17] Lancaster, K. Consumer Demand: A New Approach. New York, Columbia, 1971.
- [18] Quandt, R.E., and Baumol, W.J. "The Abstract Mode Model: Theory and Measurement." Journal of Regional Science, 6 (1966), 13-26.
- [19] Theil, H. "A Multinomial Extension of the Linear Logit Model." International Economic Review, 10 (1969), 251-259.
- [20] United States Department of Transportation. Cost of Operating an Automobile. Washington, D.C., U.S. Government Printing Office, 1972.

Discussion

Nordhaus

This is a very interesting paper applying the techniques of dynamic analysis to this problem of forecasting acceptance of new technologies. The great paradox in the study is that people pay attention to the purchase price of the automobile but not to the cost of running it.

Crow mentioned this being a problem for future research. I would just suggest one possible technical problem. There is clearly an identification problem in that automobiles that have small shares of the car market also have a high price simply because of the fact that there are economies of scale up to say 300,000 automobiles per model per year. We have almost the same problem that Taylor was talking about in the confounding of supply and demand in the empirical estimates. I think that the inconsistency between the price and cost coefficients is a tip-off that maybe the price term is biased. Also, I would say that the problems of learning and adaptation are not at all treated in Crow's paper. On the other hand, the use of lagged dependent variables is probably badly biased in this case. I might draw a comparison between Crow's work and Marchetti's work. Marchetti has used almost the identical model, not for electric automobiles but for shares in consumption of total energy. It is the same dependent variable and a completely different right hand side variable.

Parikh

I am puzzled by the fact that the price of automobiles is a significant variable but that gasoline consumption is not. I just want to ask whether you have looked at the possibility of different interest and credit rates for different income groups. This is an important factor in analyzing the advantages or disadvantages of one automobile against another since different interest

rates presume different present values and this may be mucking up some of the results that you have gotten. I also presume that you have already found that there is no multicollinearity between price and automobile gas mileage.

Crow

The data we have are highly aggregated. My expectation would be, however, that "price" and "operating costs" would be to a large degree independent of one another. As you pointed out there is no apparent collinearity. I am not sure that the income stratification problem would help, and operationally we do not have the data. But it is an interesting point, and I would like to give it further thought.

Parikh

How do you propose to take styling into account? It may be a dominant force in model choice.

Crow

The fact that General Motors' styling might have more appeal than the American Motors' has to fall within the manufacturer's dummy variables. There is no way of really taking such things into account that I can think of now.

Hutber

I think that two aspects are missing in Crow's presentation and I do not know whether they are in the paper. One which we found very important is the credit terms on which the cars are offered to the public. The other aspect peculiar to the electric car demand is the fact that as far as I can see from my work on energy, an electric car requires the creation of a new infrastructure and this is a very important factor and one which we cannot ignore if we are looking at electric cars as an alternative to an ordinary gasoline car.

Crow

The infrastructure is part of the supply problem. I am just dealing with the demand function.

Hutber

Is it not true that the US did an experiment with this matter and designed a motorcar with these high utility parameters, using an analysis of the type you do and then when they came to sell it they could not sell it?

Crow

Not to my knowledge.

Waverman

Most of the studies of automobile demand have included horsepower and weight and I have found them to be the most significant variables since they completely determine gas mileage. Why were those two variables excluded and yet you include other factors like the price of the gasoline? If you include horsepower and weight you might find a significant gas mileage coefficient with the right sign. The manufacturing dummy is picking up a lot of things, including these variables as well as service.

Crow

I think I answered the supply side question; we recognize that it is an important question but it is not the question of the study. The credit terms are an interesting question. My impression is that the credit markets are fairly competitive in the US for different kinds of automobiles. I will look into this, but it is something we had not really thought about. To the extent that credit and interest rates reflect instruments of macroeconomic policy, this would affect the absolute size but not the relative shares of automobiles.

On the question of horsepower and weight, horsepower is not important in itself. It is not something that people directly use; rather they are interested in what the horsepower will get them: the rate of acceleration, which is a significant variable in all of the regression experiments that we used. By the same token, weight in itself is not something that people value directly. Weight might have something to do with the ride and with handling and we did have ride quality ratings and handling quality ratings as reported by Consumer Reports.

Decreasing Block Pricing and the
Residential Demand for Electricity¹

Lester D. Taylor

I. Introduction

In the spring of 1974, I was approached by the Electric Power Research Institute to prepare a detailed state-of-the-art review of the econometric literature on the demand for electricity. In the course of my review, it became clear that, despite the fact that it has been well-known since the paper of Houthakker [11] that the presence of decreasing block pricing in the sale of electricity has important implications for the modeling of electricity demand. Not one existing econometric study, except for Houthakker's pioneering effort, has really adequately taken decreasing block pricing into account.

The present paper, which draws considerably from my survey paper, is addressed to the problems, both theoretical and econometric, that decreasing block pricing creates for the analysis of electricity demand. However, while the focus here is on the demand for electricity, the analysis is applicable to any commodity that is purchased subject to decreasing marginal price. Our format will be, first, to discuss the implications of decreasing block pricing for the equilibrium of the consumer and the problems created in deriving the demand functions. This occupies Section II. Section III of the paper then turns

¹I am grateful to Gail Blattenberger and John T. Wenders for many helpful discussions on the topics covered in this paper and to Nancy McKinney for secretarial assistance.

to practical solutions to the question of how to represent decreasing block pricing in the demand function. Finally, Section IV illustrates the solutions proposed in the context of a model being employed by Gail Blattenberger and myself in a study of the residential demand for electricity that has been commissioned by the Electric Power Research Institute.

II. Decreasing Block Pricing and Consumer Equilibrium

The traditional point of departure in applied demand analysis is to assume that the quantity consumed of the good (or service) in question is a function of the level of income, the price of the good, and the prices of the other goods that are consumed. On the assumption that there are n goods in the market basket, we can represent this in symbols as

$$q = f(x, p_1, p_2, \dots, p_n) \quad , \quad (1)$$

where q denotes the quantity consumed of the good in question, x refers to income, and p_1, p_2, \dots, p_n represent the prices of the n goods. Income and prices are usually taken to be market determined, and it is typically assumed, at least at the outset, that q and x refer to an individual consumer or a household.

Such a procedure is motivated by the classical theory of consumer behavior, which sees the consumer as maximizing a utility function defined over the n goods subject to his level of income. If the demand function in equation (1) has been derived through such a procedure, then, in current parlance, the demand function is said to be "theoretically plausible." However, while recent years have seen a rapidly increasing use of demand functions that are

theoretically plausible,² there does not exist a single econometric study of the demand for electricity for which this is the case. There are several reasons for this, not the least of which is the fact that the demand for electricity has usually been approached in isolation or else in conjunction with the demand for its close substitutes. This being the case, investigators have had little incentive to worry about whether their estimated demand functions satisfy the Slutsky symmetry conditions in the context of a complete system of demand functions.

However, there is another, more fundamental, reason why it is difficult to specify a demand function for electricity that exhibits theoretical plausibility. The problem lies in the fact that the consumer of electricity does not face a single price, but rather a price schedule from which electricity is purchased in blocks at a decreasing marginal price. It has been well-known since the paper of Houthakker [11] that the presence of a price schedule has important econometric implications, but the literature has focused rather narrowly on the question of the type of price--marginal or average--that should be included in the demand function. That the price schedule has implications for the equilibrium of the consumer--and therefore for the demand function itself--has not been systematically investigated.³

²See Parks [16], Houthakker and Taylor [12], Philips [17], Taylor and Weiserbs [18], Brown and Heien [3], and Christensen, Jorgenson, and Lau [6].

³The theoretical implications of quantity discounts and block tariffs were clearly understood and stated in papers by Buchanan [5] and Gabor [8]. However, the contributions of these writers (see also Buchanan [4], Gabor [9], and Oi [15]) have gone unnoticed in the econometric literature.

In order to strip the problem to its barest essentials, suppose that there are just two goods, the first of which is electricity. Denote the goods by q_1 and q_2 , and assume that q_2 can be purchased in unlimited quantities at price p_2 , but that electricity (q_1) is purchased according to a two-part tariff with decreasing block rates as follows:

Ist k_1 kwh's or less is z
 k_1 to k_2 kwh's is π_1/kwh
 more than k_2 kwh's π_2/kwh

where $\pi_2 < \pi_1$. Per usual, we shall assume that the consumer possesses a utility function $\phi(q_1, q_2)$ that is maximized subject to his level of income x .

In the usual situation it is assumed that each good has a single price, in which case the budget constraint is linear. However, with a price schedule for q_1 , the budget constraint becomes nonlinear. Its general appearance is as given in Figure 1, while algebraically it is given by⁴

$$g(\pi_1, q_1, k_1, k_2) + h(\pi_2, q_1, k_2) + p_2 q_2 = x - z \quad , \quad (2)$$

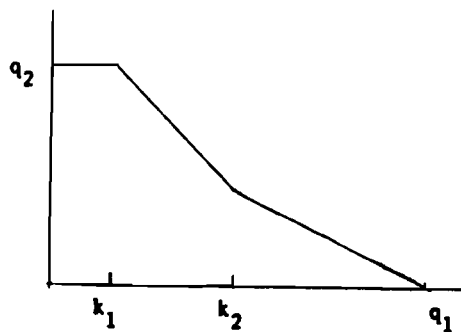

Figure 1.

⁴It is assumed that the first part of the tariff (z) must be paid even if no electricity is used.

where

$$g(\pi_1, q_1, k_1, k_2) = \begin{cases} 0 & \text{if } q_1 \leq k_1 \\ \pi_1(q_1 - k_1) & \text{if } k_1 < q_1 \leq k_2 \\ \pi_1(k_2 - k_1) & \text{if } q_1 > k_2 \end{cases} \quad (3)$$

$$h(\pi_2, q_1, k_2) = \begin{cases} 0 & \text{if } q_1 \leq k_2 \\ \pi_2(q_1 - k_2) & \text{if } q_1 > k_2 \end{cases} \quad (4)$$

The horizontal segment of the budget constraint in Figure 1 corresponds to the fixed charge of z for consumption of the first k_1 kwh's. The linear segment between k_1 and k_2 has a slope equal to $-\pi_1/p_2$, and corresponds to the π_1 part of the electricity price schedule. Finally, the segment from k_2 on, with a slope equal to $-\pi_2/p_2$, corresponds to the π_2 part of the schedule.

The nonlinear, nonconvex budget constraint in (2) has a number of consequences for the equilibrium of the consumer, his demand functions, and Engel curves, and we shall now discuss these with the aid of Figures 2-7.

Figure 2 shows equilibrium for two different indifference maps. The indifference map with solid curves gives an equilibrium on the facet of the budget constraint having a slope equal to $-\pi_1/p_2$, while the one with dashed curves gives an equilibrium on the facet with a slope equal to $-\pi_2/p_2$. Figure 3 describes an increase in π_1 , but not π_2 , while Figure 4 displays an increase in π_2 as well. In Figures 3 and 4, equilibrium following a price increase remains on the same facet of the budget constraint, but it is clear from Figure 5 that this need not always be the case. For the indifference curves in this figure show equilibrium switching from the facet with slope $-\pi_2/p_2$ to

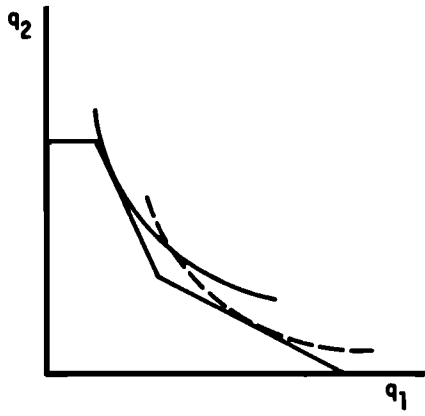

Figure 2.

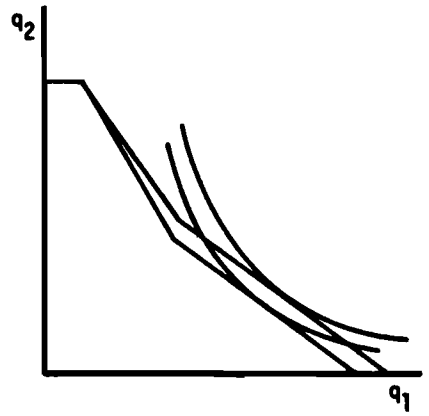

Figure 3.

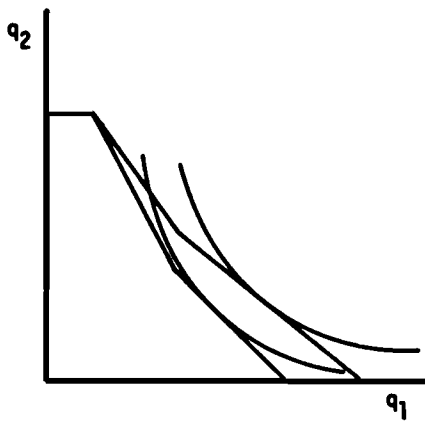

Figure 4.

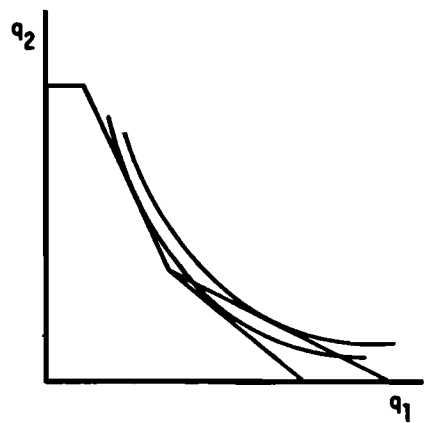

Figure 5.

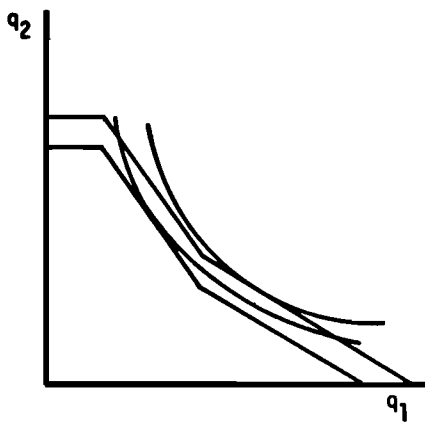

Figure 6.

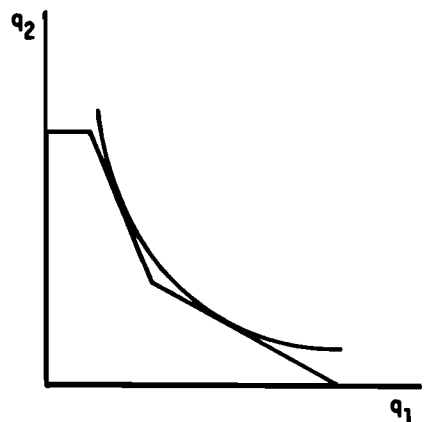

Figure 7.

the facet with a slope equal to $-\pi_1/p_2$ --that is, in this case, the price increase leads the consumer to drop back to a higher marginal rate class. Switching into a different marginal rate class can also come about by a change in income, as is evident in Figure 6. Finally, Figure 7 gives a case in which the budget constraint is tangent to the same indifference curve at two different points, thereby resulting in multiple equilibria.

Figures 2-7 thus support the following conclusions:

- 1) Because of the piece-wise linearity of the budget constraint in (2), the equilibrium of the consumer cannot be derived, as is conventionally the case, using the differential calculus. Mathematical programming must be used instead. Among other things, this means that the demand functions and Engel curves cannot, in general, be obtained as closed-form expressions from solution of the first-order conditions for utility maximization.⁵ Demand functions and Engel curves still exist, but they cannot be derived analytically.
- 2) From Figure 5, it is evident that the demand functions are discontinuous, with jumps at the points where equilibrium switches from one facet of the budget constraint to another.
- 3) From Figure 6, the same is seen to be true of the Engel curves.
- 4) From Figure 7, it is seen that for "normal" indifference curves, there will be particular configurations of prices for which the demand functions are not single-valued. This is, of course, a consequence of the non-convexity of the

⁵Moreover, this is true for all goods, not just for electricity.

budget constraint. In particular, the demand functions will be multi-valued whenever there is a configuration of prices that yield multiple tangencies of the budget constraint to the same indifference curve.

Needless to say, the econometric implications of these results are rather disturbing, for inter alia they mean that, at the level of the individual consumer, specification and estimation of a conventional demand function for electricity cannot be justified *de riguer*. However, once we consider electricity consumption for a group of households, rather than just a single household, the situation brightens. For it has recently been shown by Gail Blattenberger, my collaborator on the EPRI demand study, that as one aggregates across households, the relationship between mean consumption and price becomes a continuous function as the number of households in the group becomes large, the only requirement being that tastes or income vary across households.

Although at this point we do not know what constitutes a sufficient number of households for this asymptotic result to apply, it is almost certainly smaller than the number of residential customers in a state, which is the basic unit of observation in our analysis. In any event, it will be assumed in the discussion that follows that the number of customers being aggregated over is sufficiently large that the demand functions are both continuous and continuously differentiable.

III. The Econometrics of Decreasing Block Pricing

In this section, we turn our attention to the practical question of how decreasing block pricing should be taken into account in specifying the demand function. The conventional view since Houthakker's 1951 paper [11] is that a marginal

price, not an average price, should be used in the demand equation, the reasoning being that the consumer, in achieving equilibrium, equates benefits with cost at the margin.⁶ Also, there is the problem that when average price is defined ex post as the ratio of total expenditure to quantity consumed, as is the usual practice, a negative dependence between quantity and price is established that reflects nothing more than arithmetic. However, while the use of a marginal price⁷ for "the" price variable has some appeal, it only conveys part of the information required. For a single marginal price is relevant to a consumer's decision only when he is consuming in the block to which it attaches; it governs behavior while the consumer is in that block, but it does not, in and of itself, determine why he consumes in that block as opposed to some other block.⁸

⁶The following quotes are illustrative: "A purchaser of electricity, like any monopsonist, should base his decisions on marginal price, and this is the relevant price variable to include in the equations." (Halvorsen [10], (p. 4)); "In economic theory, consumer decisions are based on marginal prices..." (Mount, Chapman, and Tyrrell [14], (p. 6)); "The correct price variable to appear...for these commodities is, therefore not the average unit price but the price of a marginal unit of consumption, provided that consumers are well-informed." (Anderson [1], p. 6).

⁷We put to the side, for the moment, the question of "which" marginal price.

⁸Use of a single marginal price also has the problem that the same marginal price can be associated with different price schedules. See Buchanan [4].

In order to put the problem in perspective, let us return to the consumer of the beginning of this section and assume that equilibrium occurs in the π_2 block. Consider the following three cases:

- a) an increase in the customer charge z , π_1 and π_2 remaining unchanged;
- b) an increase in π_1 , z and π_2 remaining unchanged; and
- c) an increase in π_2 , z and π_1 remaining unchanged.

These three cases are depicted in Figures 8, 3, and 9, respectively.

In Figure 8, the increase in z is seen to shift the budget line downward, and leads to a reduction in the amount of electricity consumed. In Figures 3 and 9, it is seen that q_1 is decreased for Cases 2) and 3) also. However, it is to be noted, and this is the point of the exercise, that the reductions in q_1 in Cases 1) and 2) arise strictly from an income effect. That is, an increase in the customer charge and an increase in an intramarginal price are equivalent in the sense that they give rise to income effects, but not to substitution effects.⁹ However, a change in π_2 , the marginal price, yields, in traditional fashion, both an income effect and a substitution effect.

We shall see in a moment that this simple exercise essentially solves the problem of which price to include in the demand function, but before detailing this, we shall deal with the problems created by the use of ex post prices, calculated by dividing quantity consumed into total expenditure. As has been recognized by Halvorsen [10] and

⁹The only qualification to this statement arises in the situation where the increase in π_1 is sufficiently large that equilibrium switches from the π_2 block to the π_1 block. For this case, one might argue that there is a substitution as well as an income effect.

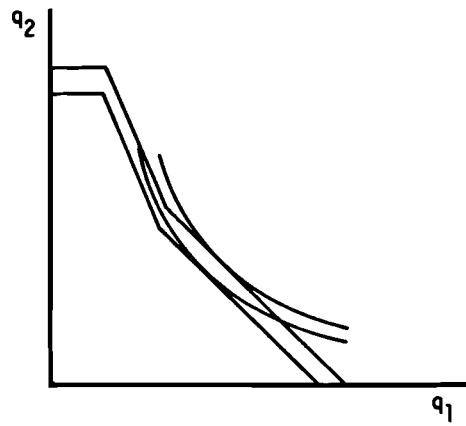

Figure 8.

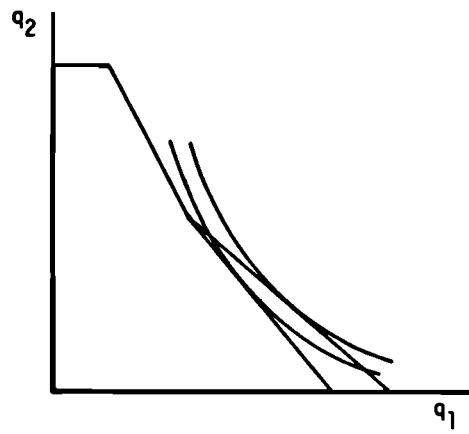

Figure 9.

others, this lends to problems of simultaneity and identification. The existence of a price schedule with decreasing block tariffs means, in effect, that the consumer faces a downward sloping supply schedule, defined with respect to average price. Equilibrium occurs at the price and quantity where demand and "supply" are equal. The details are presented in Figure 10.¹⁰

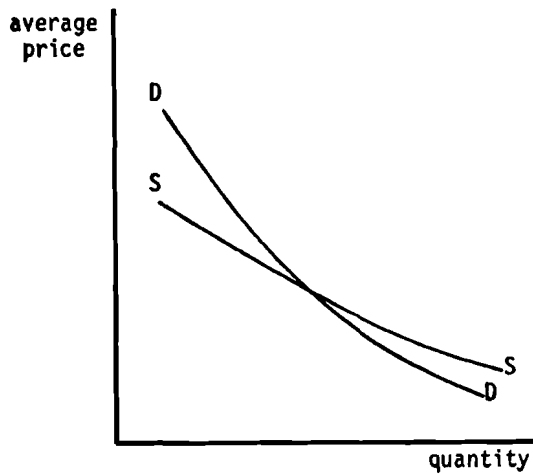

Figure 10.

If ex post average price is used as the price variable, it is clear that we have a textbook instance of simultaneity, and predetermined information is required if the two curves are to be identified. Including income in the demand function will identify the "supply" function, but the procedure to follow in identifying the demand function is

¹⁰For simplicity, I have treated the average price function as though it were continuous and smooth.

less obvious. Since supply price is presumably related to costs, one way would be to include one or more cost variables in the average price function. This is one of the procedures advocated by Halvorsen, but it has some drawbacks. Among other things, it is not clear how costs are to be measured, and a further complication is added by the fact that utilities' profits are regulated. Consequently, a preferable alternative is to relate average price to the actual rate schedule. Since, in the short run anyway, the rate schedule is independent of demand, problems of simultaneity and identification are thereby eliminated.¹¹ We shall return to this point in Section IV.

As noted earlier, the exercises illustrated in Figure 3, 8, and 9 point to the proper way of representing decreasing block pricing in the demand function. This is to include two quantities from the rate schedule, namely, the price attaching to the last block consumed in and the expenditure on electricity up to, but not including, the final block.¹² We shall refer to these two quantities as marginal price and intramarginal expenditure, respectively, and shall denote them by π_1 and π_2 . The coefficient for π_2

¹¹ Halvorsen also pursues this second alternative, but his procedure is to use block "rates" calculated from Typical Electric Bills, an annual publication of The Federal Power Commission and on which most econometric studies of electricity demand now rely for price data. However, the data published in Typical Electric Bills do not yield actual rate structures, but only approximations to them. Rates are given as the average amount paid for various kwh's of electricity consumed, but the points given--specifically, for 100, 250, 500, 750 and 1,000 kwh's/month--do not necessarily conform to blocks in the rate structures. Moreover, when the state is the observational unit, as is now conventionally the case, the problem is compounded by the fact that rate schedules usually vary from utility to utility. What is required, therefore, is a price set that is based on actual rate schedules.

¹² Since the observational unit is assumed to be an aggregate, the last block should be with reference to the "typical" customer. More about this in Section V below.

will measure the income effect arising from intramarginal price changes, while the coefficient for π_1 will measure the price effect as we conventionally use the term.

As a variation on the procedure just outlined, π_2 can be defined as the amount spent on electricity above that which would be required if the total kwh consumed were to be purchased at the marginal price π_1 . This variation is illustrated in Figure 11. π_2 , in this case, corresponds to the distance ab on the q_2 axis.

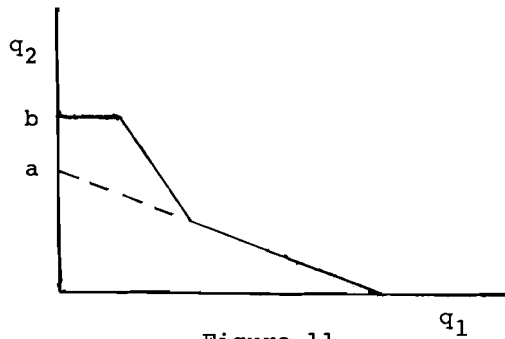

Figure 11.

Taking account of decreasing block pricing in the manners just described can be given rigorous justification in terms of the theory of two-part tariffs.¹³ However, there exists an alternative procedure that does not derive from the theory of two-part tariffs, but which follows instead from the discussion associated with Figure 10. This is to make the quantity of electricity consumed a function of the average price of electricity, but where the average price is taken from the rate schedule and not calculated ex post as has conventionally been the case. As noted earlier, calculating average price from the actual rate schedule avoids problems with simultaneity and identification.

¹³See Buchanan [4, 5] and Gabor [8, 9].

IV. A Model of Electricity Demand

We shall illustrate the procedures just described for dealing with decreasing block pricing in the context of the model of electricity demand that we are using in our EPRI study. Let me begin this section, therefore, with a description of this model.

Electricity does not yield utility in and of itself, but rather is desired as an input into other processes (or activities) that do yield utility. The processes all utilize a capital stock of some durability (lamps, stoves, water heaters, etc.), and electricity provides the energy input. The demand for electricity is thus a derived demand, derived from the demand for the output of the processes in question. However, since durable goods are involved, we must from the outset distinguish between a short-run demand for electricity and a long-run demand. In the short run, residential electricity consumption is constrained by the existing stock of electrical appliances, hence the short-run demand for electricity can be viewed as the choice of a utilization rate of the existing stock of appliances. In the long run, in contrast, the stock of appliances is variable, hence the long-run demand for electricity is tantamount to the demand for an equilibrium stock of appliances.

Following Fisher and Kaysen [7], assume that the stock of electricity-consuming capital goods is measured in terms of the number of watts of electricity that the stock can potentially draw. Denote this quantity by s , and assume that the amount of electricity consumed in the short run, to be designated by q and measured in kwh's, is given by

$$q = u(x, \pi, z) s \quad , \quad (5)$$

where $u(\cdot)$ is the utilization rate of s and is assumed to depend upon the level of income (x), the "price" of electricity (π), and any other factors (economic, social, or demographic) that might be relevant. For now, these will simply be denoted by z . In this framework, specifying the short-run demand function for electricity is thus reduced to specifying the form of the function u .¹⁴

Specifically, we postulate the function u to be given by

$$u = \alpha_0 + \alpha_1 x + \alpha_2 \pi_1 + \alpha_3 \pi_3 + \alpha_4 z \quad , \quad (6)$$

where π_1 denotes the marginal price of electricity and π_2 represents the intramarginal expenditure on electricity, both as defined in Section III above. With equal ease, and possibly more realism, u can also be specified as

$$u = \alpha_0 + \alpha_1 \ln x + \alpha_2 \ln \pi_1 + \alpha_3 \ln \pi_3 + \alpha_4 \ln z \quad . \quad (7)$$

The short-run demand function for electricity therefore becomes

$$q = (\alpha_0 + \alpha_1 x + \alpha_2 \pi_1 + \alpha_3 \pi_2 + \alpha_4 z) s \quad , \quad (8)$$

or alternatively

$$q = (\alpha_0 + \alpha_1 \ln x + \alpha_2 \ln \pi_1 + \alpha_3 \ln \pi_2 + \alpha_4 \ln z) s \quad . \quad (9)$$

Yet another specification of u is

$$u = \alpha_0 x^{\alpha_1} \pi_1^{\alpha_2} \pi_2^{\alpha_3} z^{\alpha_4} \quad . \quad (10)$$

In this case, q will be given by

$$q = \alpha_0 x^{\alpha_1} \pi_1^{\alpha_2} \pi_2^{\alpha_3} z^{\alpha_4} s \quad , \quad (11)$$

or in logarithms,

$$\begin{aligned} \ln q = \alpha_0^* + \alpha_1 \ln x + \alpha_2 \ln \pi_1 + \alpha_3 \ln \pi_2 + \alpha_4 \ln z \\ + \ln s \quad , \end{aligned} \quad (12)$$

¹⁴Balestra [2] utilizes a similar approach in modeling the demand for natural gas.

where

$$\alpha_0^* = 1n\alpha_0 .$$

Turning now to the demand for electricity in the long run, we begin by assuming that the desired stock of electricity-consuming appliances (s) is given by

$$s = \beta_0 + \beta_1 x + \beta_2 \pi_1 + \beta_3 \pi_2 + \beta_4 (r + \delta)p + \beta_5 z , \quad (13)$$

when x , π_1 , and π_2 are already defined, r and δ denote the market rate of interest and rate of depreciation of the capital stock, respectively, and p denotes the price per watt of additions to the capital stock. Finally, z is once again a vector of other relevant predictors. In words, what the model states is that the desired stock of electricity-consuming capital goods is a function of the level of income, the price of electricity, the user-cost of the capital stock, as represented by the term $(r + \delta)p$, and any other factors that might be thought to be important.¹⁵

Next, let

$$Y = Y_n + Y_r \quad (14)$$

denote gross investment in new electricity-consuming capital goods (measured in watts), where y_n denotes net new investment and y_r replacement investment. Assuming, as in (13), that depreciation is exponential,¹⁶ the latter will be given by

¹⁵Alternatively, the right-hand side of (13) can be specified in logarithms.

¹⁶Since the capital stock is measured in watts, a "one-horse shay" assumption for depreciation would probably be more appropriate. However, for present purposes, exponential depreciation is mathematically more convenient.

$$y_r = \delta s \quad , \quad (15)$$

while for y_n it is assumed that

$$y_n = \phi(\hat{s} - s) \quad , \quad (16)$$

where $0 < \phi \leq 1$. Combining (13), (15), and (16), we then have for gross new investment,

$$\begin{aligned} y &= \phi\beta_0 + \phi\beta_1x + \phi\beta_2\pi_1 + \phi\beta_3\pi_2 + \phi\beta_4(r + \delta)p \\ &\quad + \phi\beta_5z - \delta s \quad . \end{aligned} \quad (17)$$

Finally, the model is completed by noting that the rate of change in the capital stock is given by

$$\begin{aligned} \dot{s} &= y - \delta x \\ &= y_n \quad . \end{aligned} \quad (18)$$

The foregoing illustrates the "two-part tariff" approach for dealing with decreasing block pricing in the demand function. So let us now turn to the "average price" approach. To begin with, we assume that the average price of electricity, to be denoted by $\pi(q)$, can be approximated by

$$\pi(q) = \kappa q^\lambda \quad , \quad (19)$$

where κ is positive and λ negative. Next, we assume that the function in expression (5) is given by (cf. (10))

$$\begin{aligned} u &= \alpha_0 \pi(q)^{\alpha_1} x^{\alpha_2} z^{\alpha_3} \\ &= \alpha_0 \kappa^\lambda q^{\lambda \alpha_1} x^{\alpha_2} z^{\alpha_3} \quad . \end{aligned} \quad (20)$$

The demand function is then given by

$$q = \alpha_0 \kappa q^{\lambda \alpha_1} x^{\alpha_2} z^{\alpha_3} s \quad . \quad (21)$$

Taking logarithms, we have

$$\ln q = \ln \alpha_0 \kappa + \lambda \alpha_1 \ln q + \alpha_2 \ln x + \alpha_3 \ln z + \ln s \quad , (22)$$

or

$$\begin{aligned} \ln q = \frac{\alpha_0^\pi}{1 - \lambda \alpha_1} + \frac{\alpha_2}{1 - \lambda \alpha_1} \ln x + \frac{\alpha_3}{1 - \lambda \alpha_1} \ln z \\ + \frac{1}{1 - \lambda \alpha_1} \ln s \quad , \quad (23) \end{aligned}$$

where $\alpha_0^\pi = \ln \alpha_0 \kappa$.

The parameters κ and λ in (19) will be estimated by fitting the equation

$$\ln^\pi(q) = \ln \kappa + \lambda \ln q \quad , \quad (24)$$

obtained by taking logarithms of (19) to the actual rate schedule. With κ and λ obtained from the rate schedule, the other parameters in (23) are thereby identified, consistent with our earlier statement that calculating average price from the rate schedule avoids problems with identification.

V. Concluding Comments

I shall close with a few comments regarding the data requirements of the model just described. The demands for price data are especially severe, since we require knowledge of individual rate schedules. And while these are collected and published for US electrical utilities by the Federal Power Commission, a substantial effort is required to extract and tabulate the requisite information.

As part of our EPRI study, we have undertaken construction of the price data set required, and I am happy to report that the task is completed. In particular, residential rate schedules for each utility in the US for 1950 through 1973 are now in storage in the Data Resources, Inc. data retrieval system, and from these we have constructed time series, both annual and quarterly, for π_1 and π_2 as defined in Section III.

Since rate schedules vary across utilities (and sometimes across communities served by the same utility), it has been necessary, in constructing values of π_1 and π_2 that refer to a state as a whole, to aggregate over rate schedules. Our procedure in doing this has been as follows. First, for each rate schedule, we isolate on the rate schedule the marginal price and intramarginal expenditure that corresponds to the mean kwh consumption of the customers subject to the schedule. This gives a π_1 and π_2 for each schedule. We then calculate π_1 and π_2 for the state as a whole as a weighted average, using customers as weights, of the π_1 and π_2 for each schedule.¹⁷

¹⁷Our procedure for aggregating across rate schedules with the average price approach is different than that just described. With this approach, we first, construct a rate schedule for the state as a whole and then fit equation (24) to this schedule. The state schedule is obtained as a weighted average of individual rate schedules in the state using the number of customers attaching to each schedule as weights.

References

- [1] Anderson, K.P. "Residential Demand for Electricity: Econometric Estimates for California and the United States." The Rand Corporation, R-905-NSF, January 1972.
- [2] Balestra, P. The Demand for Natural Gas in the United States. North Holland Publishing Company, 1967.
- [3] Brown, M., and Heien, D. "The S-Branch Utility Tree: A Generalization of the Linear Expenditure System," Econometrica, 40 (July 1972), 737-748.
- [4] Buchanan, J.M. "Peak Loads and Efficient Pricing: Comment." Quarterly Journal of Economics (August 1966), 463-471.
- [5] Buchanan, J.M. "The Theory of Monopolistic Quantity Discounts." Review of Economic Studies, 20 (1952-1953), 199-208.
- [6] Christensen, L.R., Jorgenson, D.W., and Lau, L.J. "Transcendental Logarithmic Utility Functions." Discussion Paper No. 285, Harvard Institute of Economic Research, March 1973. Forthcoming in the American Economic Review.
- [7] Fisher, F.M., and Kaysen, C. A Study in Econometrics: The Demand for Electricity in the United States. North Holland Publishing Company, 1962.
- [8] Gabor, A. "A Note on Block Tariffs." Review of Economic Studies, 23 (1955-1956), 32-41.
- [9] Gabor, A. "Further Comment (On Peak Loads and Efficient Pricing)." Quarterly Journal of Economics, 80 (August 1966), 472-480.
- [10] Halvorsen, R. "Demand for Electric Power in the United States." Discussion Paper No. 73-13, Institute for Economic Research, University of Washington, Seattle, 1973.
- [11] Houthakker, H.S. "Some Calculations on Electricity Consumption in Great Britain." Journal of the Royal Statistical Society (A), 114, Part III (1951), 351-371.

- [12] Houthakker, H.S., and Taylor, L.D. Consumer Demand in the United States. Second Edition. Harvard University Press, 1970.
- [13] Houthakker, H.S., Verleger, P.K., and Sheehan, D.P. "Dynamic Demand Analyses for Gasoline and Residential Electricity." Lexington, Massachusetts, Data Resources, Inc., 1973.
- [14] Mount, T.D., Chapman, L.D., and Tyrrell, T.J. "Electricity Demand in the United States: An Econometric Analysis." Oak Ridge, Tennessee, Oak Ridge National Laboratory, ORNL-NSF-49, June 1973.
- [15] Oi, W.Y. "A Disneyland Dilemma: Two-Part Tariffs for a Mickey Mouse Monopoly." Quarterly Journal of Economics, 85 (February 1971), 77-96.
- [16] Parks, R.W. "Systems of Demand Functions: An Empirical Comparison of Alternative Functional Forms." Econometrica, 37 (October 1969), 629-650.
- [17] Phlips, L. "A Dynamic Version of the Linear Expenditure Model." Review of Economics and Statistics, 54 (November 1972), 45-58.
- [18] Taylor, L.D., and Weiserbs, D. "On the Estimation of Dynamic Demand Functions." Review of Economics and Statistics (November 1972), 459-465.
- [19] Taylor, L.D., and Weiserbs, D. "The Demand for Electricity: A Survey." The Bell Journal of Economics and Management Science, 6, 1 (Spring 1975).

Discussion

Nordhaus

Taylor discussed the very important and difficult problem of decreasing block pricing and the residential demand for electricity. This is a very deep paper attacking a very fundamental problem which has plagued the econometrics of electricity supply and demand since Benjamin Franklin. The fundamental difficulty occurs when you have nonlinear prices, or steps in your pricing rule. Here you do not have only one good, but rather there are different goods, and that is the way that they have to be treated formally. I am not absolutely convinced that Taylor has solved the problem of the nonconvexities. Let me just briefly mention for those who are more engineering oriented that what you have instead of a convex problem is a nonconvex problem or an integer programming problem; there are no general solution techniques for solving integer programming problems, so I am not surprised that the integer programming problem involved in decreasing block tariffs poses very great difficulties both for individual consumers and for econometricians.

Hutber

Just three short observations. One is that Taylor must not forget that consumption of electricity has been very heavily tied to the appliances purchased so you must have the appliances in your model--the number of appliances, the type of appliances, and how much they are used. Once you get an appliance you always tend to use it even if the electricity is expensive.

When it comes to rates I am not terribly familiar with the American rates, but I am puzzled by this intermediate block. I guess it can really only be explained by a sort of old fashioned idea of premium and nonpremium electricity. We used to have a lighting rate in the UK years ago which said

that you had a high premium on your electricity for lighting and this is a sort of carry-over from that. But if that is the reason, the analysis in terms of premium and nonpremium electricity is a different problem altogether. We have studied it for gas and we have separate rates which isolate people who are on premium types of fuel use and fuel for heating. That is the way we dealt with it.

Finally, I am worried because I do not see the logic of decreasing block tariffs apart from the emotive ones that you should try and conserve your electricity and increase rates for social reasons; but I cannot understand the underlying cost economies of it because when you add load to the system it has been our experience in the UK generally speaking that the load comes in at the low load factor of the system as a whole and therefore there is no discrimination. Quantity does not entitle you to reduce cost on the scale factor.

Waverman

On the block price problem and the possibility of discontinuity, I cannot see how aggregation is a solution unless you assume that all consumers are completely dissimilar, yet for most of our other problems in economics we sometimes have to assume that they are completely identical to get the solution. But if all consumers of all households are identical, then that aggregation problem surely cannot solve the block price problem.

Taylor

Let me answer the three questions from Hutter. The first one concerns the appliance stock. That matter is discussed explicitly in the paper. Let me just mention that the model of household demand for electricity distinguishes very explicitly between short-run demand and long-run demand. The short-run demand is essentially the choice of the utilization rate of a given stock of household appliances, with that stock being constant. In the long run the stock is variable and the long-

run demand for electricity is essentially the demand for the stock of household appliances itself. We have some work going on and we hope to be able to disaggregate the household stock down to eight or ten major household appliances and we expect to have the demand equation in the long run for each of them. The model will have all of the standard variables--income, the opportunity cost of holding the stock, price of competing goods, etc.

Now the second and third questions: I have a great deal of difficulty distinguishing between them. Let me put them together and first let me say that I do not want to in any way defend the pricing policies of the US utility industry. For the problem that I am concerned with, these policies are largely irrelevant because it is a fact for the empirical demand analyst that the decreasing block structure exists, that there is not a two-part rate but that there are in face multipart rates and that in our empirical econometric analysis we have to be able to deal with these facts. Let me just say in parenthesis, though not in defense, that the US utility industry is very reluctantly coming to the conclusion that something called marginal cost pricing in electricity does exist. In the past they have essentially priced so as to cover their capital cost. In addition, they were employing the discriminating monopolist solution to extracting some consumer surplus from under the demand function in order to cover the capital cost from there, and in the end blocks they are essentially covering the marginal energy costs of the electricity.

Then on Waverman's question on aggregation: This is really not covered in my paper for this Workshop. It appears in another paper and the principal author is Gail W. Blattenberger.¹

¹See Gail W. Blattenberger and Lester D. Taylor, "A Theorem on Aggregation of Demand Functions When Budget Sets are Non-Convex."

Dynamic Energy Analysis as a Method for
Predicting Energy Requirement

Malcolm Slesser

Introduction

There are two well developed methods of estimating energy demand. One balances demand and supply through price, using the elegant methods of economic analysis. The weakness of this method lies in its inability to deal with large step changes in demand, supply or price; in its inability to deal with system lags; with the fact that energy cannot be substituted for by anything but energy and that therefore an economic balance does not necessarily mean an energy balance. The second method takes historical data to relate parameters such as GNP to energy use, and by estimating the growth of one estimates the growth of the other. Alternately, one may, like Weinberg [4], search for upper limits and postulate a figure twice the US per capita energy use, and proceed to assume that the world could never exceed such a figure, globally multiplied.

A third method is now possible, though means of implementation are far from complete. This is the method of energy analysis, in which the energy requirements of the factors of production are established from real life data, in which the interacting parameters are distinguished and separately accounted for.

We all appreciate, when we think about it, that in a broad way one may trade energy against such factors as time, system centralisation, intensity, haste, space and so on. So far, very little analytical work has been published on these relationships. We know, for example, the energy that was

required to produce a Detroit automobile in 1971 [1], but we do not yet know how that energy requirement varied with the rate of production. We do know how much energy is required to make steel from iron ore, what the factor of waste does to this process, what technological possibilities exist, and what are the thermodynamic upper limits to the economy of energy. In fact, piecemeal we know a great deal, but we have yet to assemble enough of the whole to make a proper estimate of the energy requirements for our society as it develops.

What I propose to do here is simply to demonstrate the way in which energy analysis can be used to assess energy requirement--as opposed to demand. Because of my involvement in the analysis of energy and space through the food production sector, the model I am going to present will estimate the energy requirement for food production in the enlarged (nine country) EEC territory. I do not even vouch that the parameters I have inserted are absolutely correct, but I can say they are not absolutely incorrect. My purpose is to present a method, not to make a prediction upon data which are still rudimentary. If I convince you of the method, then we have armies of competent people able to assemble the necessary data and causal relationships.

Model

First, we need a model of the economy. Such a model for the food sector is depicted in Figure 1. Note that I have aggregated all the land, all the people, averaged their per capita GNP, and thus their eating habits. If you argue that this is carrying aggregation too far, you may as well argue that the common agricultural policy (CAP) of the EEC is itself too aggregate. In any event it is a simple matter to break the model into national sectors, and then aggregate the results. Table 1 lists the statements in the computer program used.

We start with the supposition of a fixed amount of agricultural land, GA, which is slowly being eaten into by the

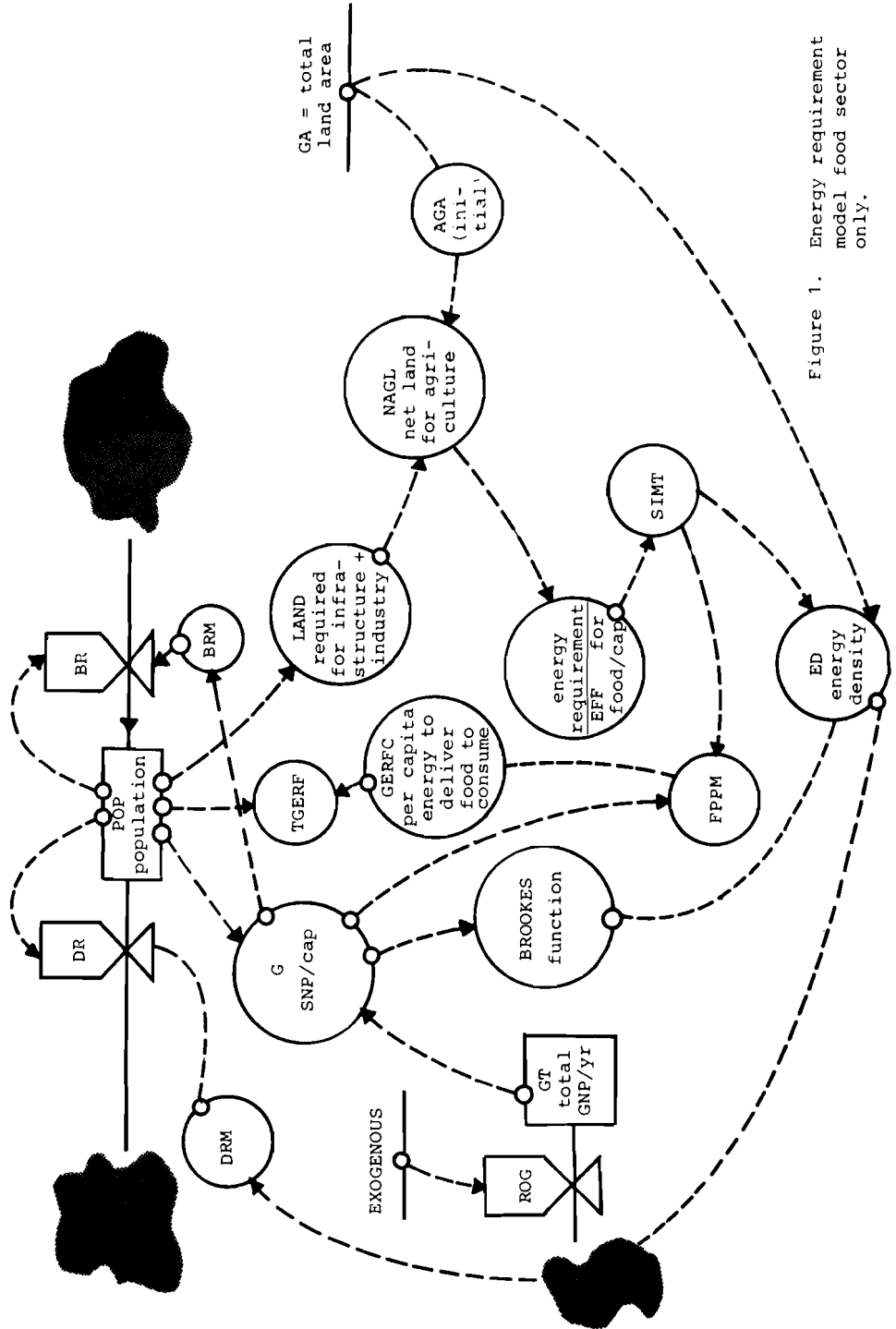

Figure 1. Energy requirement model food sector only.

Table 1. Gross energy requirement illustrative model.

```

* GROSS ENERGY REQUIREMENT ILLUSTRATIVE MODEL
NOTE FOOD SECTOR ECONOMIC GROWTH TERM EXOGENOUS
NOTE DATA IS FOR ENLARGED (NINE) EEC
C POP0=254.957E6 POPULATION AT INITIAL TIME
C AGL=99.07E6 AGRICULTURAL LAND AREA, HECTARES INITIAL TIME
C GT0=843.638E9 GNP INITIAL TIME IN US DOLLARS
C GA=152.876E6 TOTAL AREA OF EEC TERRITORY, HECTARES
C AT3=25 1/PLANNED ECONOMIC GROWTH RATE
N TIME=1972 INITIAL TIME
N GT=GT0
N POP=POP0
L POP.K=POP.J+(DT)(BR.JK-DR.JK) POPULATION
R BR.KL=POP.K/AT1.K BIRTH RATE
A AT1.K=TABHL(BRM,G.K,0,1800,100) BIRTH RATE FACTOR
T BRM=20/20/24/29/32/36/38/42/45/50/53/56/59/61/63/65/66/67/69
R DR.KL=POP.K/AT2.K DEATH RATE
A AT2.K=TABHL(DRM,ED.K,.01,.65,.04) DEATH RATE FACTOR ON ED
T DRM=30/33/43/51/60/67/75/81/86/90/90/90/90/90/90/90
NOTE LAND AVAILABLE FOR FOOD PRODUCTION
C LU=.04 LAND CONSUMED PER EXTRA INHABITANT
L LAND.K=(POP.K-POP0)*LU LAND REQUIRED FOR DOMESTIC AND INDUSTRIAL USE
A NAGL.K=AGL-LAND.K NET LAND AVAILABLE FOR AGRICULTURE
A AA.K=NAGL.K/POP.K AGRICULTURAL AREA AVAILABLE PER CAPITA
NOTE EXOGENOUS ECONOMIC GROWTH RATE
L GT.K=GT.J+(DT)(ROG.JK) GROSS NATIONAL PRODUCT, US DOLLARS
R ROG.KL=GT.K/AT3 RATE OF GNP GROWTH
A G.K=GT.K/POP.K PER CAPITA GNP
NOTE ENERGY PREDICTION THROUGH GNP
A EC.K=(.00017)*G.K*(LOGN(G.K)) BROOKES FUNCTION
A TEC.K=EC.K*POP.K TCE CONSUMPTION BASED ON GNP PREDICTION
NOTE ENERGY DENSITY
NOTE ENERGY FOR FOOD TO FARM GATE
A EF.K=TABLE(EFF,AA.K,.05,.6,.05) MINIMUM ENERGY PER CAP FOOD TO FARMGATE
T EFF=1/.19/.09/.067/.055/.043/.037/.033/.031/.03/.0295/.029
NOTE ENERGY FOR FOOD TO CONSUMER
A ED.K=TEC.K/GA ENERGY DENSITY, TCE/HECTARE
A SIM.K=TABHL(SIMT,ED.K,1,13,2) SYSTEM INTENSIFICATION MULTIPLIER
T SIMT=.85/1.2/1.5/1.8/2.2/2.4/2.7
A FPPM.K=TABHL(FPPMT,G.K,1000,7000,1000) FOOD PROCESSING MULTIPLIER
T FPPMT=1/1.2/1.45/1.7/2/2.2/2.4
A GERFC.K=EF.K*SIM.K*FPPM.K ENERGY REQUIREMENT FOOD TO CONSUMER
A TGERF.K=GERFC.K*POP.K TOTAL ENERGY REQUIREMENT FOR FOOD IN ))" EEC
A FEF.K=TGERF.K/TEC.K FRACTION TOTAL ENERGY DEVOTED TO FOOD
NOTE SPECIFICATION
SPEC LENGTH=1999/DT=.2/PRTPER=1/PLTPER=1
PLOT TGERF=T(25,70)/EF=F(0,.05)/AA=A(.2,.5)/POP=P(2E8,3E8)/G=G(2E3,10E3)
PRINT EF,SIM,FPPM,GERFC,TGERF,FEF,AA,G,POP
RUN

```

twin factors of population growth, POP, with its need for a domestic infrastructure, and industrial growth. Using typical UK data, I have assumed that 0.04 hectares of land is sequestered for those purposes in the interests of every additional member of the EEC population, and that all this land comes from agricultural land--that is, land that is arable or high quality pasture. Let us now assume that the EEC wishes to be self-sufficient in food, other than in tropical products. The energy requirements for food production has been estimated by the methods of energy analysis [3], and found to depend upon two factors: the quality of the diet and the amount of land available per capita (see Figure 2). The diet, according to Mr. J.-P. Charpentier of the International Institute for Applied Systems Analysis (IIASA) is a function of the income level. Beyond a certain level, increases in energy use result not from eating more meat but from eating more processed or packaged food. The model therefore shows a multiplier term to account for this (FPPM). The multiplier term is somewhat arbitrary, since it is based on limited data (see Table 2).

Table 2. Energy to provide food to consumers.

| Country | Year of date | Energy to farm gate | Additional energy to reach consumer | GNP/cap US \$ | Population density |
|-----------|--------------|---------------------|-------------------------------------|---------------|------------------------|
| | | GJ/cap | GJ/cap | | People/km ² |
| USA | 1963 | 10 | 18 | 3,150 | 20 |
| UK | 1972 | 10 ¹⁾ | 6 | 2,500 | 226 |
| Australia | 1965/9 | 4 | 6 | 2,500 | 2 |
| Israel | 1969/70 | 12 | ? | 1,650 | 149 |
| FRG | 1960 | 2 | 6 | 1,300 | 248 |

Source: M. Slesser, XXV Conference Latin American Series, Guatamala, 1974.

¹⁾ This allows for the fact that 40% of the food is imported.

Source: Slesser [3], p. 1193.

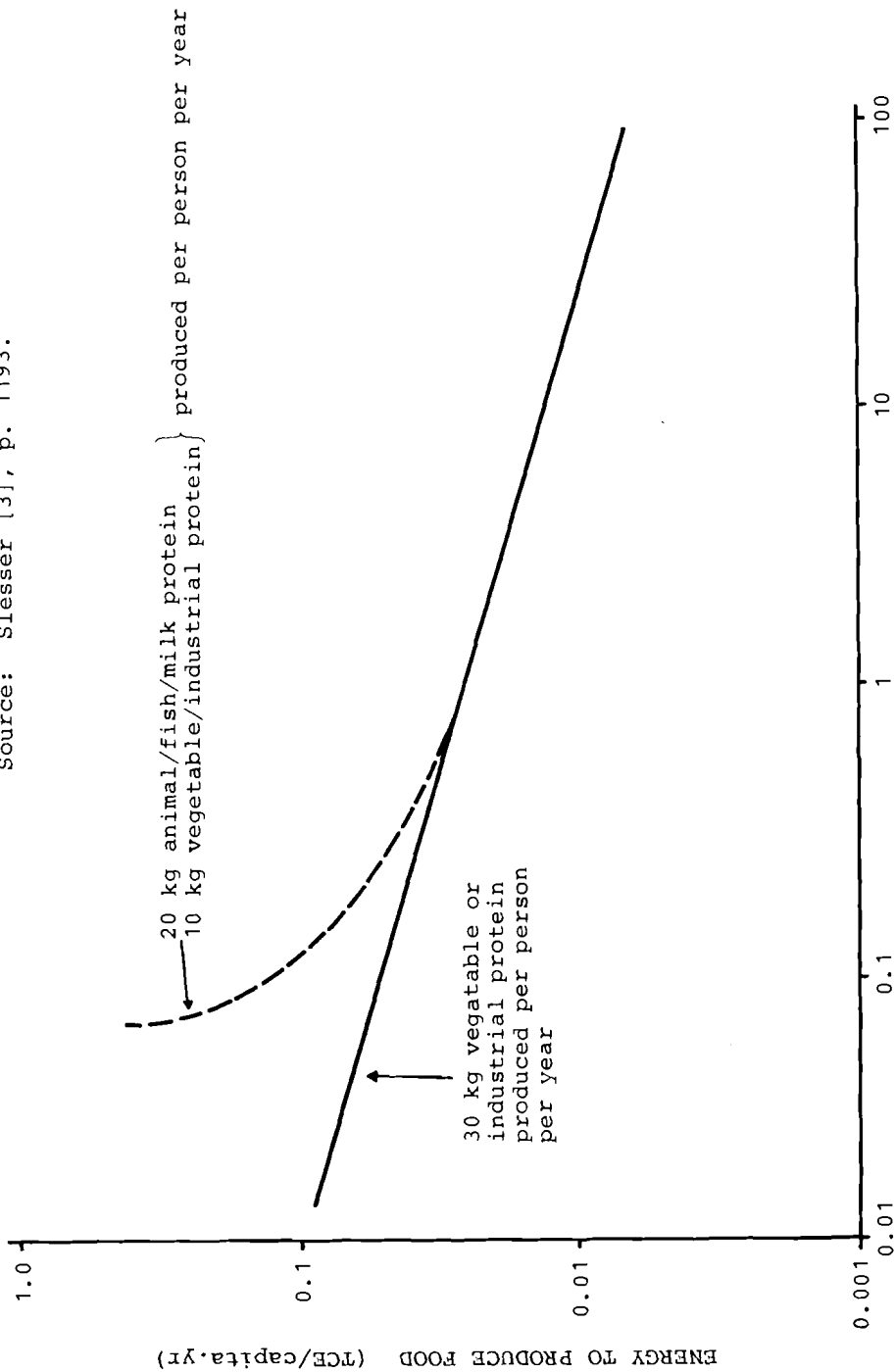

Figure 2. Agricultural land per person (ha/capita): energy intensity for self-sufficiency in food.

Since the model is dynamic, it must have a driving function. There are two. There is the internal driving function of population growth, whose birth and death rates are related, and the external driving function of GNP growth, GNP/capita, and energy density. Both these parameters are depicted in Figures 3 and 4.

Energy Analysis

Energy analysis, formerly called energy accounting or energy budgeting, was given rigorous formulation at the August 1973 workshop run by the International Federation of Institutes for Advanced Study (IFIAS) [2]. What energy analysis sets out to do is to assess the energy that has to be sequestered from the global stock in order to make a given good or service available. It takes account of such factors as the energy requirement for energy, namely the fact that of a barrel of oil leaving an oil well, several percent of that barrel will have to go for providing the capital and exploration investment for the next oil well, for pumping of the oil to the point of shipment, for refining and finally for conveying the oil to the consumer. Possibly 20% of the barrel vanishes along the way. Energy analysts use a measure called the Gross Energy Requirement (GER), and like to express it as so many mega joules per kilogramme of product or unit of service. Clearly there is no absolute value that can be obtained by looking up a table and various methods of arriving at values have been developed.

What must be made clear is that the IFIAS workshop did nothing more than close in on a methodology and a set of conventions. What is to be made of the methodology is still to be determined, and to this end IFIAS are holding a second workshop to examine the interface between energy and economic analysis in June 1975.

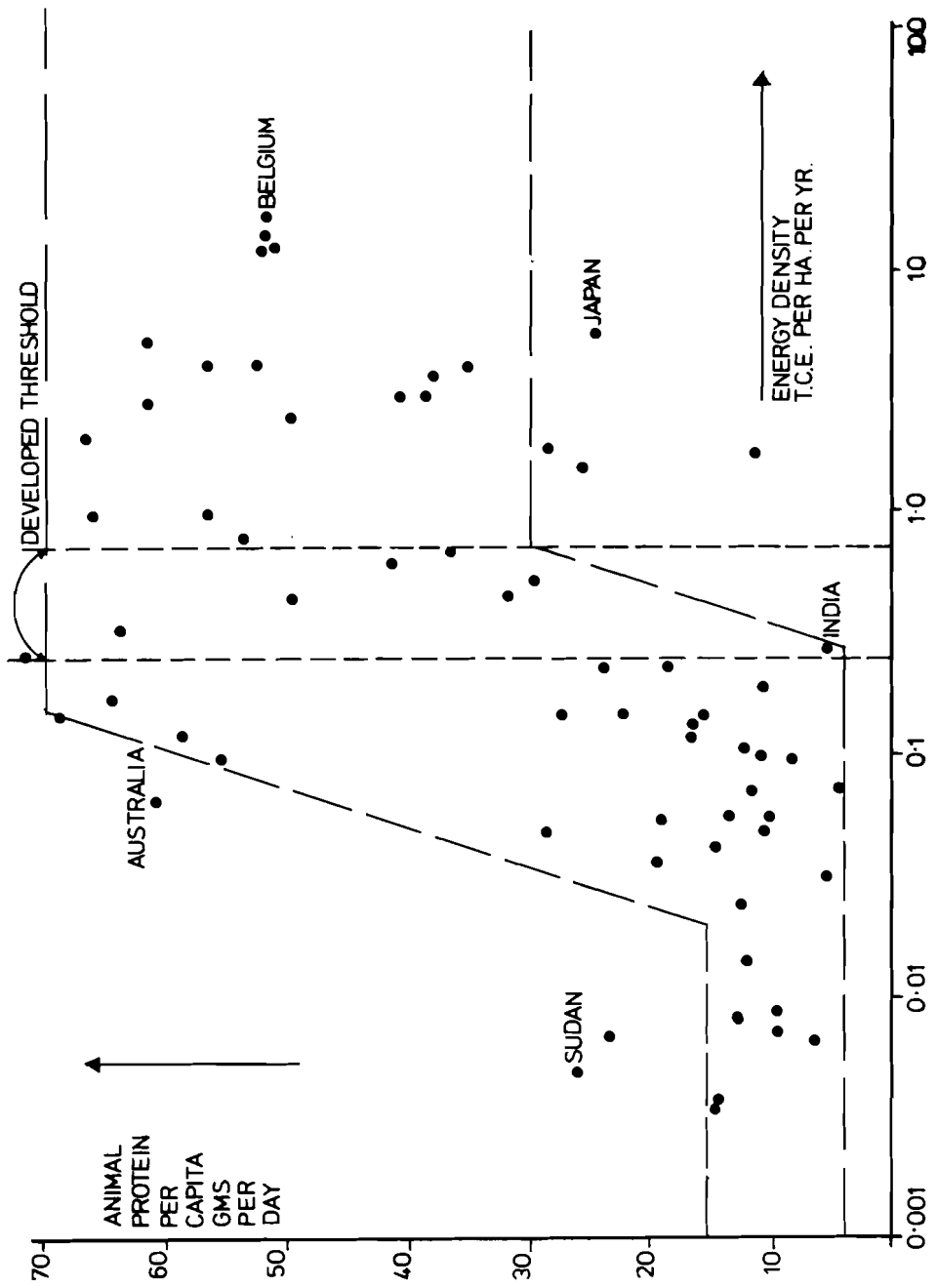

Figure 3. Animal protein consumed per capita versus energy density.

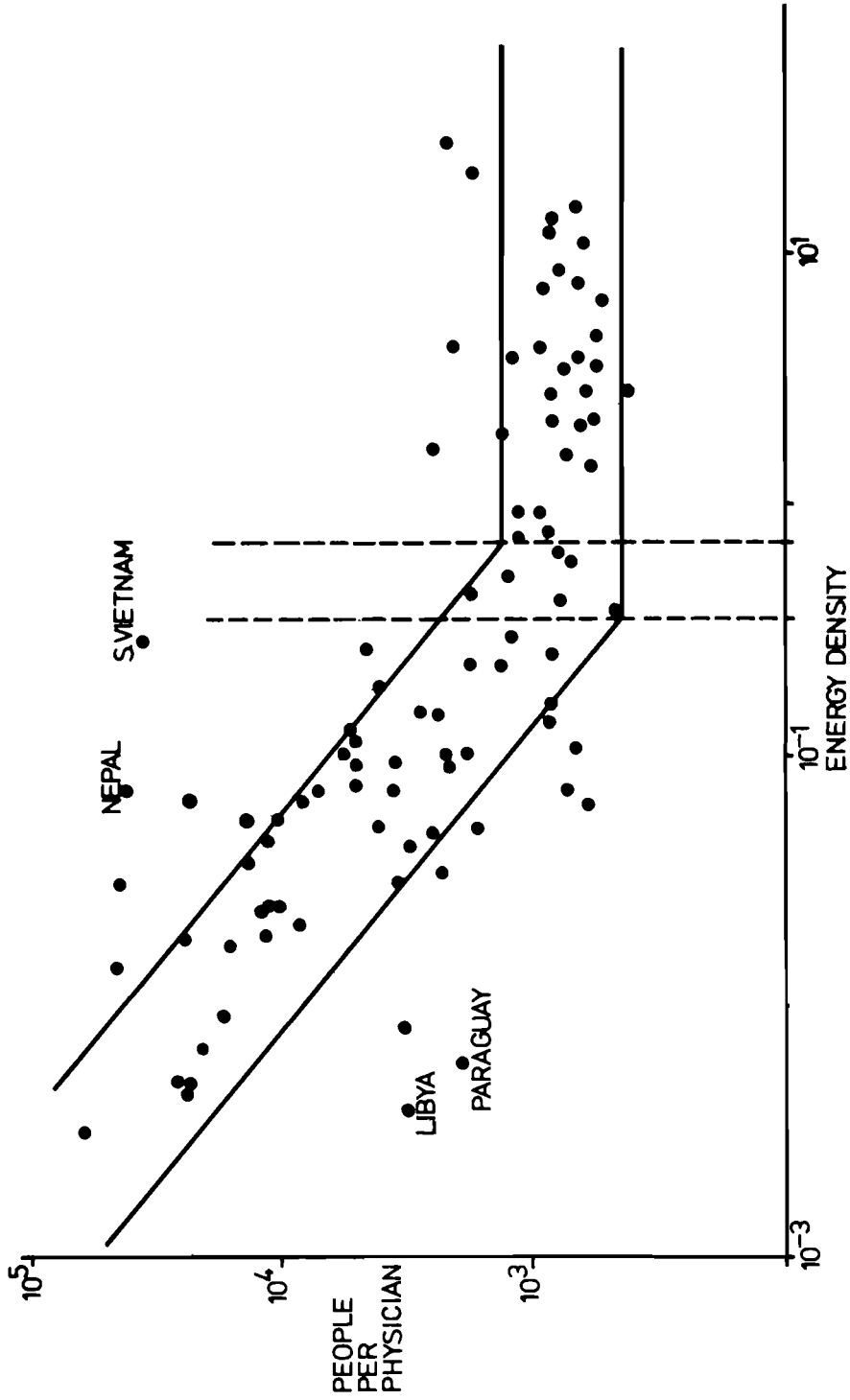

Figure 4. Number of people per physician in various countries versus energy density from data in Table 2.

Model Dynamics

Were the entire economy being modelled, then the driving function(s) would be integral, and given initial conditions would set the model in motion. Since in the example presented at this time, only the food sector is being modelled, an external driving function is needed. This driving function is taken as the anticipated GNP growth factor, with all its faults and uncertainties. Since our concern is demonstration of a method, not prediction, I trust this loose coupling will be accepted for what it is.

Sensitivity Testing

The chosen rate of GNP growth has a second order effect on energy requirements for food in a developed economy.

Model Results

Figure 5 and Table 3 depict the model results, which are exceptionally simple. The total energy requirement (GER) for the food production sector rises from an estimated 25.8 mtce in 1972 to sixty-seven mtce by the year 1999. An additional value of this method is that it identifies so clearly why the energy need has risen with time. It is largely because of the diminishing quantity of agricultural land per capita (AA) and the increasing emphasis on food processing.

The interpreter or policy maker who does not like these factors can then consider what should be done about it: land reclamation, a campaign for fresh food, incentives to grow food in the garden, and so on.

Interpretation

The interpretation of a model of this type should be accompanied by a regional disaggregation. For example, in the agricultural sector the land available per capita in England is about .21 hectares, while that in France is closer to 0.5

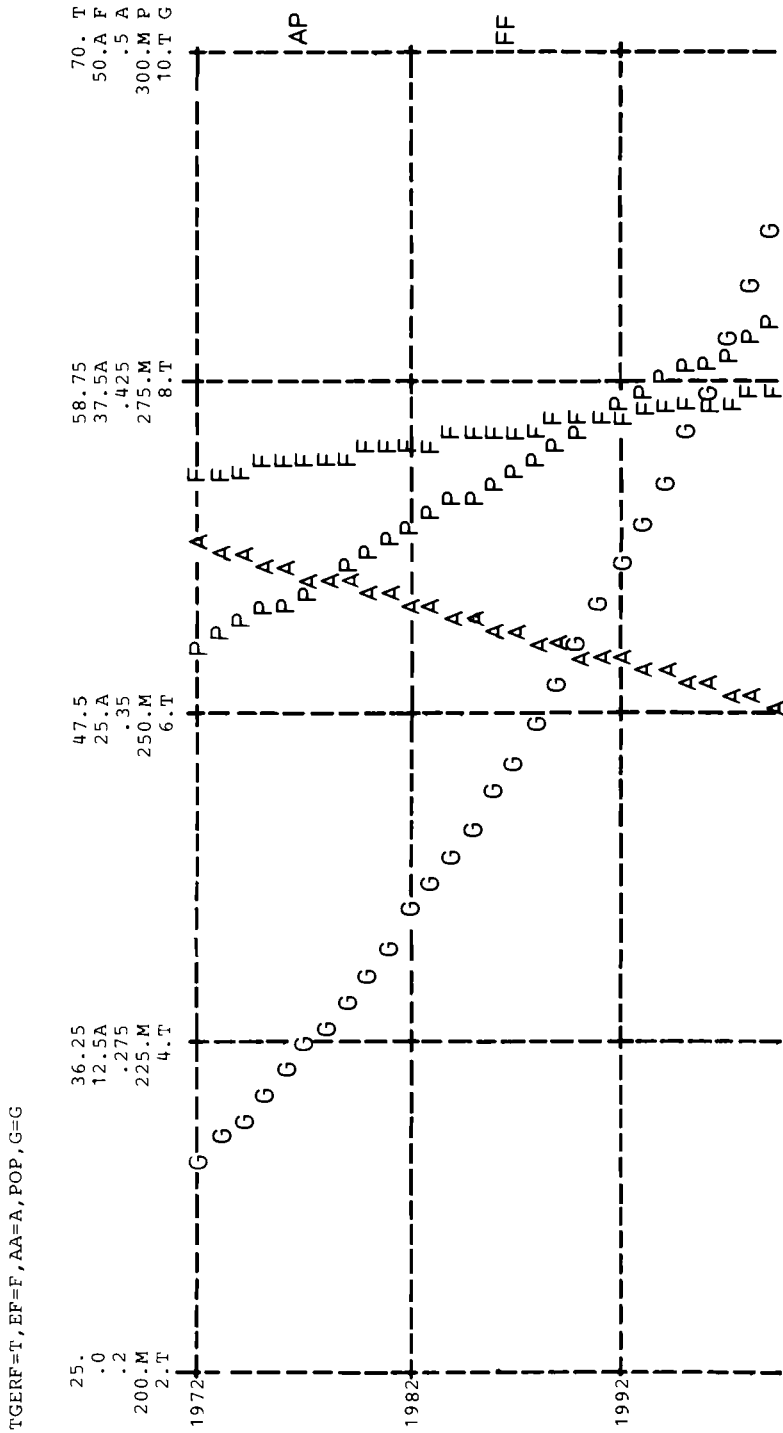

Figure 5. Gross energy requirement illustrative model.
4/29/75

Table 3. Gross energy requirement illustrative model.

| E+00 | EF | | SIM | | FPPM | | GERFC | | TGERF | | FEF | | AA | | G | | POP | |
|-------|--------|--------|--------|--------|--------|--------|-------|--------|--------|------|------|------|------|------|------|------|------|------|
| | E-03 | E+00 | E+00 | E+00 | E+00 | E+00 | E+00 | E+06 | E-03 | E+00 | E-03 | E+00 | E+00 | E+00 | E+00 | E+00 | E+06 | E+06 |
| 1972. | 33.914 | 1.9206 | 1.5272 | 0.9948 | 25.362 | 21.820 | 38858 | 3308.9 | 254.96 | | | | | | | | | |
| 1973. | 34.030 | 1.9895 | 1.5580 | 1.0548 | 26.983 | 22.209 | 38713 | 3431.8 | 255.82 | | | | | | | | | |
| 1974. | 34.145 | 2.0615 | 1.5898 | 1.1191 | 28.725 | 22.618 | 38569 | 3559.2 | 256.69 | | | | | | | | | |
| 1975. | 34.260 | 2.1368 | 1.6229 | 1.1880 | 30.598 | 23.048 | 38425 | 3691.4 | 257.56 | | | | | | | | | |
| 1976. | 34.374 | 2.2077 | 1.6571 | 1.2576 | 32.499 | 23.420 | 38282 | 3828.5 | 258.43 | | | | | | | | | |
| 1977. | 34.489 | 2.2488 | 1.6927 | 1.3128 | 34.041 | 23.469 | 38139 | 3970.7 | 259.30 | | | | | | | | | |
| 1978. | 34.692 | 2.2917 | 1.7354 | 1.3761 | 35.805 | 23.617 | 37997 | 4118.1 | 260.18 | | | | | | | | | |
| 1979. | 34.716 | 2.3365 | 1.7813 | 1.4449 | 37.720 | 23.805 | 37855 | 4271.0 | 261.06 | | | | | | | | | |
| 1980. | 34.829 | 2.3833 | 1.8289 | 1.5181 | 39.766 | 24.011 | 37714 | 4429.6 | 261.95 | | | | | | | | | |
| 1981. | 34.941 | 2.4484 | 1.8782 | 1.6068 | 42.232 | 24.398 | 37573 | 4594.1 | 262.83 | | | | | | | | | |
| 1982. | 35.054 | 2.5250 | 1.9294 | 1.7077 | 45.037 | 24.895 | 37433 | 4764.7 | 263.72 | | | | | | | | | |
| 1983. | 35.165 | 2.6051 | 1.9825 | 1.8162 | 48.058 | 25.418 | 37293 | 2921.6 | 264.62 | | | | | | | | | |
| 1984. | 35.277 | 2.6888 | 2.0250 | 1.9208 | 50.999 | 25.809 | 37154 | 5125.1 | 265.51 | | | | | | | | | |
| 1985. | 35.388 | 2.7000 | 2.0631 | 1.9712 | 52.515 | 25.430 | 37015 | 5315.4 | 266.41 | | | | | | | | | |
| 1986. | 35.499 | 2.7000 | 2.1025 | 2.0152 | 53.869 | 24.961 | 36877 | 5512.7 | 267.31 | | | | | | | | | |
| 1987. | 35.609 | 2.7000 | 2.1435 | 2.0608 | 55.275 | 24.508 | 36739 | 5717.4 | 268.22 | | | | | | | | | |
| 1988. | 35.719 | 2.7000 | 2.1859 | 2.1082 | 56.736 | 24.072 | 36601 | 5929.7 | 269.13 | | | | | | | | | |
| 1989. | 35.829 | 2.7000 | 2.2300 | 2.1572 | 58.253 | 23.651 | 36464 | 6149.9 | 270.04 | | | | | | | | | |
| 1990. | 35.938 | 2.7000 | 2.2757 | 2.2081 | 59.829 | 23.245 | 36328 | 637.3 | 270.95 | | | | | | | | | |
| 1991. | 36.047 | 2.7000 | 2.3230 | 2.2609 | 61.466 | 22.854 | 36192 | 6615.1 | 271.87 | | | | | | | | | |
| 1992. | 36.155 | 2.7000 | 2.3722 | 2.3157 | 63.168 | 22.476 | 36056 | 6860.8 | 272.79 | | | | | | | | | |
| 1993. | 36.263 | 2.7000 | 2.4000 | 2.3498 | 64.318 | 21.901 | 35921 | 7115.6 | 273.71 | | | | | | | | | |
| 1994. | 36.371 | 2.7000 | 2.4000 | 2.3568 | 64.727 | 21.093 | 35787 | 7379.8 | 274.64 | | | | | | | | | |
| 1995. | 36.478 | 2.7000 | 2.4000 | 2.3638 | 65.138 | 20.314 | 35652 | 7653.8 | 275.57 | | | | | | | | | |
| 1996. | 36.585 | 2.7000 | 2.4000 | 2.3707 | 65.550 | 19.565 | 35519 | 7938.0 | 276.50 | | | | | | | | | |
| 1997. | 36.692 | 2.7000 | 2.4000 | 2.3776 | 65.963 | 18.843 | 35385 | 8232.8 | 277.43 | | | | | | | | | |
| 1998. | 36.798 | 2.7000 | 2.4000 | 2.3845 | 66.378 | 18.147 | 35253 | 2538.5 | 278.37 | | | | | | | | | |
| 1999. | 36.904 | 2.7000 | 2.4000 | 2.3914 | 66.794 | 17.477 | 35120 | 8855.6 | 279.31 | | | | | | | | | |

hectares. The application of averages to the entire EEC territory (.38) would put the agriculture of intensive areas like England at a comparative disadvantage compared to less intensive areas such as France. By less intensive is meant areas which can produce the same output per capita for less input.

Total System Modelling

The energy analysis method allows one to make a total system model of a given economy by establishing the feedback loops to maintain energy balance. Energy reaches an economy in two forms, as prime energy or as embodied in imports. It leaves the economy as exported energy, prime or secondary, plus exports. In the case of the developed countries, exporting prime energy is not a likely phenomenon. Exporting energy in the form of goods and services is a major part of their activities.

Figure 6 depicts a possible causal loop diagram for an economy modelled in energy analytic terms. The model must seek to utilise the parameters of land area, agricultural area and numbers of people, and relate these through the relationships of energy and space, energy and time, and energy per capita. The model must consider industrial development and construction of energy producing systems as a matter of energy investment. Thus, according to the energy source, there are energy requirements for energy, both in capital and maintenance terms, and energy requirements for industrial development, land reclamation, energy conservation, housebuilding and so on. In addition there are the (yet to be clearly identified) gearing factors of system intensification, haste of production, centralisation and devolution.

The economy must operate upon an energy balance. Either the economy invests in its own internal energy producing systems or it invests in industrial systems to make goods to buy imported energy or it declines. Till recently, developed economies were clever at imparting value added to raw materials,

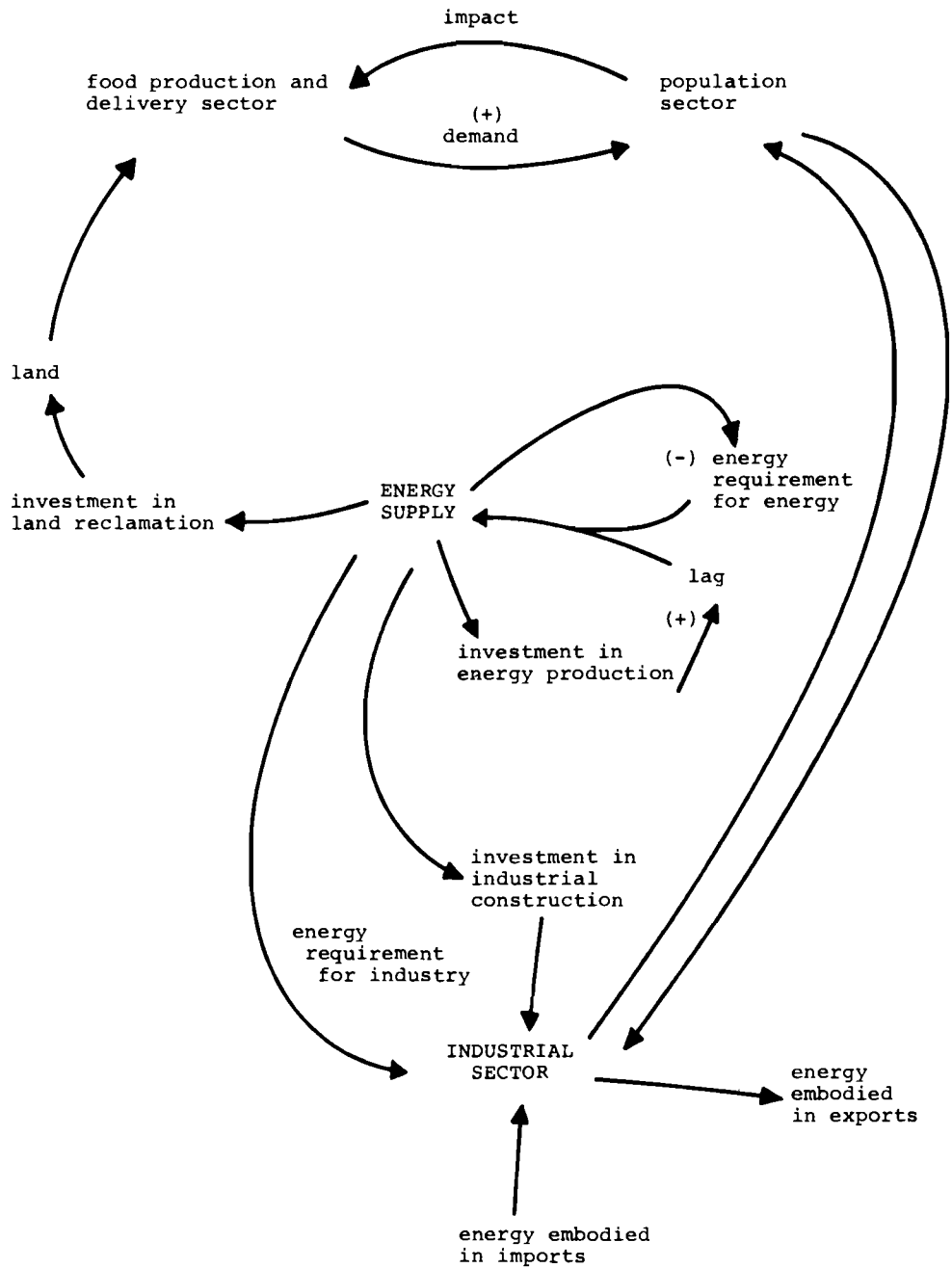

Figure 6.

and hence found it expedient to buy in energy. OPEC has shown that the balance of these options has altered.

For both strategic and economic reasons there is a move away from that situation, and eventually a time will come when fossil energy may not be available for import, and countries are tied by availability of low grade uranium or sunshine. It is surely the transition from the present situation towards that future situation that must exercise the minds of those planning future energy requirement with its comparative factors of supply and demand.

One may ask what is the internal driving function of the model so roughly depicted in Figure 6. To answer this one must join forces with those involved in economic analysis. Because the other key factor in the real world is people, and their needs, and hence their demands, coupled to their ability through their skills to match these demands. I question whether any model, of the type presented here or of an econometric type can answer the whole question. Both play an essential role, and the role of the Energy Analytic Model is to test the viability, in energy terms, of the econometric models. This is so given that an energy analytic model can test the scenario, and test a wide number of variations based upon the perceived objective of the country at some time in the future.

To take a crude example, Figure 7 depicts the outcome of the current scenario for the UK modelled dynamically. The energy growth has been allowed to expand at the EEC forecast of 3.8%, the proposed CEGB programme of nuclear reactor construction has been allowed to proceed, and the British Petroleum Company's forecast of North Sea oil production in the English and Scottish sectors has been superimposed. We see that far from having a rosy energy future, such a scenario drops the UK into a rapidly widening energy gap by 1988. There are other scenarios which could close this gap and provide a stable energy future, but they have no part in this paper.

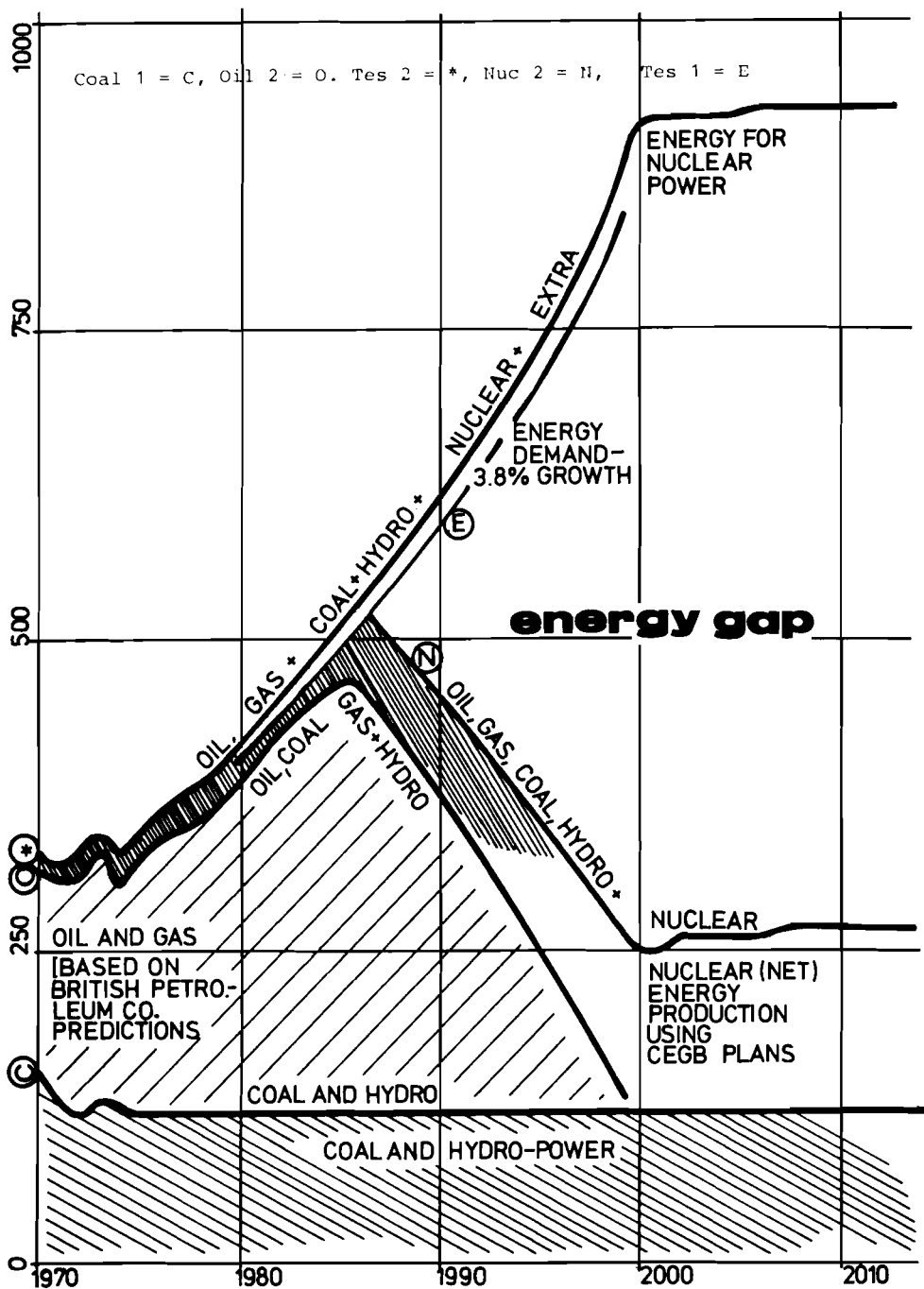

Figure 7. Model of British energy dynamics.

Conclusion

Energy analysis can provide a means of determining energy need or requirement, and when modelled in a dynamic form can test the energy consistency of the scenarios evolved by econometric methods. However, the data for such modelling is far from adequately developed. There is a need for studies to relate energy with space, with time, with intensification, with system centralisation, with scale of production. There is a need for information on the energy investment per unit of output whether it be cars or energy itself. This paper merely seeks to open up an avenue of thought, not to present to the outcome of a detailed and thorough study.

References

- [1] Berry, R.S., and Fels, M.F. "Energy Cost of Automobiles," Science and Public Affairs, 29, 10 (1973).
- [2] "Energy Analysis Methodology." Conference 25-30 August 1974. Report Number 6. Guldmedshytten, Sweden, International Federation of Institutes for Advanced Study, 1974.
- [3] Slesser, M. Journal of the Science of Food and Agriculture, 24 (1973), 1193-1207.
- [4] Weinberg, A.M. Letter to the editor. Science (December 1, 1972), 933.

DiscussionNordhaus

On the work of Slesser, it seems to me that this is to be interpreted as an input-output analysis with special attention to the energy sector. Why pay so much attention to energy and not to labor, capital, and balance of payments, to the zinc constraints, to the copper constraints, to the air constraints? I think that there is a burden of proof on the investigator to show that the energy constraint is in some sense a fundamental constraint to look at; or maybe we should look at them all. The reason to look at energy cannot refer to the ability to recycle. We cannot recycle labor services, or capital services or performances of the Vienna Opera, so it cannot simply be the non-recyclability of energy. There is no justification in this paper or in other papers in this area for the thought that there is a special normative significance to the energy content which can be called a BTU theory of value. There is no proof that the energy content of a good is in some sense the best single indicator of the social scarcity of that good, rather than a labor content, or the capital content, or the direct and indirect content of the Vienna Opera in that particular good.

Newlon

On the Slesser paper, I looked for an explanation of why you need to concentrate on the energy balance instead of the economic balance. I was puzzled by some of the sweeping statements on the first page of Slesser's paper and particularly I noted a statement that energy cannot be substituted for anything but energy. I can conceive of a production function for agriculture where the farmer can substitute land for energy by shifting to an agricultural process that uses more land and less energy-intensive fertilizer.

Häfele

I would like to supplement this by saying that from studying some production functions in the Energy Group it became fairly obvious that information and education can be considered substitutes for energy.

Khazzoom

I wanted to ask Slesser whether, in the system that he envisions, electricity can be produced other than as a factor of production. Why would final demand for electricity be satisfied at all? It is a net loser of energy obviously; why would the system produce it?

Slesser

I said at the outset that a tremendous amount depends on one's perception of the energy in the economic system. The perceptions just expressed appear to be significantly different from mine. I would like to say right at the outset that I propose no BTU theory of value, that is, a joule theory of value. Labor and energy represent the ultimate inputs. Capital is simply prior investment of energy and labor. I do not think that anybody can dispute that the only thing in limitation on this planet is thermodynamic potential. It is the only thing that cannot be recycled. If you have access to thermodynamic potential you can in fact recycle or produce virtually everything.

I will try to say something in the very short time I have. First of all, we recognize that energy does two things: we have to distinguish the energy required for work (in the engineering sense) purposes from the energy required for heat purposes, and I think our demand modelling ought to reflect this. Second, I have found to my surprise there is remarkably little information available on how much energy is consumed as work, and how much is simply wasted. Taking Newlon's question--the example of land--would he not accept that there is a finite amount of land on the earth, that there is a finite number of people, and

that they are growing in number? Therefore we really do not have the option you mentioned, that is to say, to farm more land less intensively. The only option you have is farming the land more intensively. But, of course, there is a relation between land and energy, as I have shown elsewhere. (See M. Slesser, Journal of the Science of Food and Agriculture, 24 (1973), 1193-1207.)

Parikh

If you farm in outer space, you have a lot more land to farm.

Slesser

Yes, but if you read any sort of energy analysis on the cost of getting to outer space you can see that it does not represent any meaningful solution for the next century.

Problems of Energy Demand Analysis

P. S. Tsvetanov and W. D. Nordhaus

Demand is one of the principal variables linking energy systems with a society. Different indicators, causal factors, and methods currently used in the field of energy demand have been discussed at the IIASA Workshop on Energy Demand.¹ The following is a brief review of the work being done in IIASA on energy demand.

1. Econometric Models

The first direction for our review concerns some conceptual problems of energy demand as a derived and final demand. This type of demand implies that the important factors will be both those factors determining the demand for final products and those factors between the competing inputs of the productive process. The technique outlined in this study specifies the way in which demand and technology interact so as to give a final derived demand for energy inputs. The bases for the estimates are the production function and the preference function for final goods. The detailed results are given in the paper prepared for this Workshop by W.D. Nordhaus [8]. A subsequent development of this general approach to energy demand is given in the second part of this paper.

The second direction for our review is a series of studies emphasizing econometric analysis of energy demand (see Nordhaus [8], Tsvetanov [9]). The studies cover some characteristic countries or groups of countries: the USA; several countries of Western Europe (Belgium, France, the FRG, Italy, Netherlands, the UK); the USSR and some countries of

¹Workshop on Energy Demand, May 22-23, 1975, Laxenburg, Austria, International Institute for Applied Systems Analysis.

Eastern Europe; Japan; and some developing countries. The coverage of this analysis, which includes Eastern European countries, constitutes an extension in coverage over the international estimates made up to now in the field of energy analysis.

In the first step we suggest that the scope of the work covers the aggregate energy demand and the energy demand in the individual consumer sectors: energy, transport, industry except energy, and commercial-residential sectors estimated for different countries as functions of income, price, population, and other determining factors. The cross-section analysis and the pooling of individual countries, having the same preference functions and production functions, are the second step of this work. But this international approach causes some problems, and so let us review them next.

1) The gathering of adequate data is one of the most crucial and difficult tasks. The prices and the consumption of different fuels are not available or incomplete for some countries. On the other hand, the regression analysis needs a larger number of initial variables than those usually used in many of the models of energy demand.

2) In many empirical studies, a constant elasticity model is specified:

$$\theta_{it} = A v_{1it}^{\alpha_1} v_{2it}^{\alpha_2} \dots v_{nit}^{\alpha_n} e^{\gamma} .$$

Although the constant elasticity model is a useful first step, it is desirable to allow variable elasticities. For the purposes of the cross-section analysis a variable elasticity model (VEM) was chosen to allow for some degree of heterogeneity between countries. In the VEM the value of the elasticity for a particular factor depends on the level of the factor.

3) The correct specifications of the model should also allow for the gradual adjustment of demand through time, in response to changes in the causal factors. This lagged response affects the relationships between the use of fuel and the existing stocks of equipment and appliances. The size of these stocks depends on past as well as current decisions and consequently on the past and current level of explanatory factors. Two main difficulties arise in the studies. First, the time response is quite long (five to ten years) with respect to the sample periods for an individual country (fifteen to twenty years). Second, the choice of the lag structure is a difficult problem connected with the lag of all variables, the autocorrelations between the errors, relationships between the length of the lag and the degree of the polynomial, etc. A simple specification is the geometric lag structure in which both short-run elasticities (response in the current time period) and long-run elasticities (response when complete lag is allowed) are estimated. It is the long-run elasticities, however, that have the most direct bearing on the growth of demand.

Such a model could be the following:

$$\theta_{it} = \theta_{it-1}^\lambda v_{1it}^{\alpha_1}, \dots, v_{nit}^{\alpha_n} \exp(\gamma_1/v_{1it} + \dots + \gamma_n/v_{nit})$$

where the short-run elasticity for v_n is $(\alpha_n - \gamma_n/v_n)$, long-run elasticity for v_n is $(\alpha_n - \gamma_n/v_n)/(1-\lambda)$, and

i denotes the i^{th} country;

t denotes the t^{th} year;

θ_{it} is the quantity of energy demand;

v_n is the level of n^{th} factor such as

income, price, population, etc.; and

λ , α_n , γ_n are unknown parameters.

Some results we hope to obtain from this work include:

- a) estimates for short-run and long-run elasticities for different factors for national studies;
- b) the relationship between long-run elasticities and the independent variables in these countries; and
- c) recommended models for short-run and medium-run forecasting of energy demands for different groups of countries.

From the beginning, we have been able to obtain preliminary results from data mainly for countries in Western Europe. Some results of the analysis are given in Nordhaus [8]. For the countries of Eastern Europe, including the USSR, we have started collecting available data and making preliminary analysis of the factors and the methods of forecasting. This work is in progress. The cooperation with the national institutes in this field would be very fruitful.

2. Engineering Approach to the Energy Demand

The second line of research in the field of energy demand in IIASA is an engineering approach very close to the problem of energy budget and energy content in different goods: How much energy is needed for producing a car, a house, or a meal of 3,000 Kcal, etc. This basic information will be used later on in order to obtain the qualitative scenarios. Detailed methods and results on this question are to be found in the Workshop paper of J.-P. Charpentier [2].

3. Energy Demand in Energy Sector Models

In addition to investigations of the exact form of energy demand functions and conditional projections of demand, the other task of energy demand studies is to provide a fundamental building block in the development of sectoral energy models. Side by side with the supply (or technological)

investigations, energy demand models provide the necessary information to analyze the future development of overall energy balances, utilization, and policy analysis. In the following we will describe how energy demand studies fit into different overall analysis at IIASA and elsewhere.

3.1 Role of Econometric Modelling in Overall Models

Before describing the question of individual projects, it is useful to review the question of the relationship between technology, demand functions, and preference functions. Consider an economy with n produced goods, and m non-produced goods of which (x_1, \dots, x_k) is the vector of gross outputs, while (q_1, \dots, q_n) is the vector of final demands, and (r_1, \dots, r_m) is a vector of resource endowments or non-produced goods.

To keep the discussion simple, we assume that the technology can be represented by linear inequalities which relate the final demands to gross outputs and resource endowments. Thus we have

$$q \leq Ax \quad ,$$

$$q \leq Br$$

where the inequalities represent the constraints under which the economy or region must operate.

In addition, there is a preference function for the economy. The preference function may simply be the market demand functions in the case of a market economy, or the plan in the case of a planned economy, or some mixture of the two in a mixed economy. The economic problem can be seen as maximizing the preference function $U(q_1, \dots, q_n)$ subject to the constraints of the technology:

$$\max U(q_1, \dots, q_n)$$

subject to

$$q \leq Ax \quad ,$$

$$q \leq Br \quad .$$

When considering the preference function for an individual sector, such as the energy sector, it is important to note that determination of the preference function is one of the most difficult parts of the problem in projecting future resource needs or in making policy analysis. In both planned and unplanned economies, the preference function reflects the relative valuation (or trade-off) between different final goods that the economy can produce, and differences in the trade-off will lead to quite different patterns of resource utilization. Two important final goods which may have different relative valuation in different economies are the value of environmental quality and the value of energy consumption. Depending on their relative valuation, very different results will be found for the utilization of different technologies, for controls on emissions, or for location of industry. It should also be emphasized that the preference function is not a "scientific" question but a problem of values, or "trans-science" as it has sometimes been called.

Logically, the determination of the preference function is quite different for goods which are allocated by prices and for goods which are allocated by central planning. Most econometric work, such as that of Nordhaus [8] cited above, considers the determination of preference functions for goods which are allocated by prices. In this case, individual consumers or firms make decisions on the basis of relative

prices on the one hand and relative productivities or relative preference on the other. By using the theory of consumer or firm decision making, the objective information on prices and quantities can be mathematically integrated to determine the preference functions of the economic agents. In this case, it is useful to consider the preference functions so obtained as the aggregate of individual preference functions for these goods. Under the allocative rules of a market economy, these preference functions are then the appropriate preference function to use in decision making.

Thus, for market economies, agents of the economy have preference functions over their consumption goods. Given the relative prices, incomes, as well as tax and institutional structure, the agent then has a budget constraint which it must respect. We can then assume that agents find the most preferred bundle of commodities subject to the budget constraint. This process determines a set of market demand functions, where the quantities demanded are a function of prices, income, tax, and institutional structure. Under certain conditions, it is possible to mathematically integrate these market demand functions to determine a preference function which is consistent with them. Write this market-revealed preference function as:

$$V = V(q_1, \dots, q_n) \quad .$$

(It must be kept in mind that the V function will change with changes in tax or institutional structure.) We can then write the planning problem for a market economy--using the market revealed preference function as the preference function--as:

$$\max V(q_1, \dots, q_n)$$

subject to

$$q \leq Ax \quad ,$$

$$q \leq Br \quad .$$

For goods which are allocated by central planning, the preference function is based on other sources--the preferences of the planners. In this situation, tools other than the econometric technique are appropriate. Nevertheless, it should be noted that the econometric techniques may be very valuable. Even in centrally planned economies, where many goods are centrally allocated, a large share of the final goods is allocated in part by decisions of individual consumers or firms. Thus, although production decisions are made according to the principles of planning, the consumption or purchase decisions are made by individual consumers. In this case, the knowledge of the individual preference functions, as revealed in the individual decisions, is extremely important in guiding the planning process. The easiest way to introduce this question into the framework discussed above is to postulate a consumer response function, which relates the desired quantity of final goods purchased by individual consumers or firms to the incomes of these agents and the relative prices of the different consumer goods:

$$q \leq f(y, p)$$

where q is the purchases of the final demand vector, y is the income, and p the vector of prices of final goods, including taxes, congestion costs, etc. We then have our modified problem:

$$\max W(q_1, \dots, q_n)$$

subject to

$$q \leq f(y,p) \quad ,$$

$$q \leq Ax \quad ,$$

$$q \leq Br \quad .$$

Clearly, it is extremely important for a planned economy to have precise information on the form of the consumer response function; deviations from the plan due to exclusion of this constraint can be just as important as deviations which arise from misspecification of the technological constraints. In addition, once the knowledge of the consumer response functions is established, it makes it much easier to implement the plan. By the introduction of appropriate prices and income, it can be ensured that the plan, the consumer response function, and the technology are all consistent.

To summarize, we feel it is quite important to understand the role of preference functions in the energy area. These preference functions--whether through the form of market demand functions in market economies or of consumer response functions in planned economies--are an essential ingredient in making future projections, in performing policy analysis, and in understanding the evolution of energy systems.

3.2 Comparison of Energy Options in Model Societies

One of the fundamental topics of research at IIASA is the comparison of different energy options. In the first investigation (see Häfele and Manne [3]), a detailed description of different technologies (nuclear fission and fossil) is combined with relatively simple demand equations. To this is added a second, more general, step, the comparison of various energy options having larger supply alternatives, combined with more general criteria for evaluation. This second step, in its turn, could result in two different concerns: first, a comparison of a single model

society, and, second, comparisons of a few societies operating interdependently with distinct objective functions. In the second investigation, the societies would correspond to the different regions of the world. For the two studies, and particularly for the second, it is very important to build and introduce realistic demand models as primary energy input to the simulation models.

3.3 Regional Economic Models

A second important line of research currently underway at IIASA and elsewhere is the development of regional energy models. At IIASA, for example, the work of W. Foell considers the models for three different regions: Wisconsin, Rhone-Alpes, and the German Democratic Republic. A common theme in all these models is the question of efficiently allocating the regions' resources to meet a given set of demands.

3.4 Models With International or Interregional Trade

One of the important unresolved issues in energy modelling is the problem of how to model the process of international or interregional trade between different areas. Most models either ignore international trade or model trade as a competitive process. It is at this point that the difference between the demand functions for a region and the preference function for the region are of great importance. In most regions, even in market economies, national decision makers are unwilling to let the market forces of demand determine the patterns of trade. (The energy report Project Independence is a prime example of this tension.) One topic important for future work at IIASA is the investigation of models of international trade, with special attention to the superposition of national preferences upon the demand relations.

The main problem in modelling international trade is modelling the reactions of nations or regions to possibilities for trade. In early work (see Nordhaus [7]), the assumption

was made that trade is simply the reflection of competitive market forces. In the light of recent events on the international energy market, it is desirable to attempt to introduce other forms of reaction. One suggestion would be to assume that each region plans so as to maximize the preference function of that region; the equilibrium of this joint maximization could be considered as a possible outcome for the process of international trade. Although this seems a very likely process, it also introduces deep game-theoretic problems in that the strategies of the different regions are not independent.

Assuming that the problem of modelling the interaction between different regions is successfully resolved, there remain a number of problems of integrating energy demand into multi-country models.

1) The first problem is determining the energy demand functions for different countries. It is hoped that the work now going on at IIASA and elsewhere will allow simple but realistic specifications of national energy demand equations.

2) The question of the technology, or supply side, is the other crucial building block for these models. Again work at IIASA as well as elsewhere should help with the appropriate specifications.

3) The problem of integrating the energy sector into the rest of the economy is a third important problem in model construction. Some progress has been made in this area lately (see Hudson and Jorgenson [5]). It is probable that optimization models will have a very simple linkage, perhaps relying on decomposition principles. In simulation models, on the other hand, it is possible to link with existing regional models, such as Mesarovic-Pestel [6], which allow for a more complete feedback between the energy sector and the rest of the economy.

4) Efficiency of energy use is a further question. An increase in efficiency could be of two types: a) in the energy conversion and transmission processes, and b) in the energy efficiency of final use. The processes of the first type of increase, with the exception of cases where different new processes are included (MHD topping cycles, etc.), have gradually approached efficiency plateaus. Energy use efficiency of the second type, final use, in turn can be improved in two ways: by increasing the efficiencies of the energy using processes directly (insulation and use of heat pumps for space heating, electronic automobiles, etc.) and by cascading energy using processes such as (integrated industrial processes). These aspects of future energy demand are very significant and have to be assessed.

5) A further question which deserves discussion is the issue of limits to energy consumption imposed by mechanisms external to the energy sector. It has been suggested, for example, that the climatic effects of waste heat and carbon dioxide impose constraints on the energy production.

If it could be shown that there are indeed rigid limits to the amount of energy production, this would be a very great aid in long-run forecasting, since this would form a kind of firm ceiling in the distant future. Preliminary investigations, however, cast doubt on the existence of firm limits. First the response of the environment is probably continuous rather than discontinuous for most important variables, so that no jumps in behavior are likely to occur. Second, limitations on energy consumption pose very significant social costs, so that it is unlikely that the optimal environmental policy would be an invariant function of time. Finally, there are many techniques for short-circuiting the link between energy and environment, so that by paying a slightly higher price it is possible to have the same environmental effect and higher energy consumption.

In sum, we feel that it is doubtful that any rigid upper limit on energy consumption will be uncovered; rather, demand analysis will have to rely on the standard techniques discussed above. It is clear that the introduction of energy demand into general energy sector models is an important task on the research agenda of IIASA and other organizations. We hope that the collaboration of IIASA with different groups will continue to help the spread of methods of analysis as well as to resolve very difficult analytical issues which lie ahead.

References

- [1] Charpentier, J.-P. "Overview on Techniques and Models used in the Energy Field." Research Memorandum RM-75-8. Laxenburg, Austria, International Institute for Applied Systems Analysis, 1975.
- [2] Charpentier, J.-P. "Toward a Better Understanding of Energy Consumption." In Proceedings of the Workshop on Energy Demand. IIASA CP-76-1. Laxenburg, Austria, International Institute for Applied Systems Analysis, 1976.
- [3] Häfele, W., and Manne, A.S. "Strategies for a Transition from Fossil to Nuclear Fuels." IIASA RR-74-7. Laxenburg, Austria, International Institute for Applied Systems Analysis, 1974.
- [4] Hoffman, K. "A Unified Planning Framework for Energy Systems Planning." Upton, New York, Brookhaven National Laboratory, 1972.
- [5] Hudson, E.A., and Jorgenson, D.W. "U.S. Energy Policy and Economic Growth 1975-2000." Cambridge, Massachusetts, Harvard and Data Resources, 1974.
- [6] Mesarovic, M., and Pestel, E. "Multilevel Computer Model of World Development System." IIASA SP-74-1-6. Laxenburg, Austria, International Institute for Applied Systems Analysis, 1974.
- [7] Nordhaus, W.D. "The Allocation of Energy Resources." Brookings Paper on Economic Activity, 1973, November 1973.
- [8] Nordhaus, W.D. "The Demand for Energy: An International Perspective." In Proceedings of the Workshop on Energy Demand. IIASA CP-76-1. Laxenburg, Austria, International Institute for Applied Systems Analysis, 1976.
- [9] Tsvetanov, P.S. "Econometric Analysis of the Energy Demand." Unpublished manuscript. Laxenburg, Austria, International Institute for Applied Systems Analysis, 1974.

II. INDIVIDUAL SECTORS

Electricity and Energy Savings in Industry

J. Bouchet

It may seem astonishing to hear stated that the use of electrical processes in industry could lead to savings of primary energy.

It is known that the development of nuclear energy may save considerable amounts of hydrocarbons. However, it is generally believed that the transformation of hydrocarbons into electricity may reduce the efficiency of primary fuel utilization to as little as 35% of its potential. Comparisons of primary fuel utilization for electricity with conversion of thermal into mechanical energy, do overlook the fact that losses are low in the actual use of electricity.

Thus with conventional fuels, losses are moderate during production--as for instance in industrial steam generators--while they are high in distribution and, above all, in use. For example, a survey conducted in 1970 in the Federal Republic of Germany showed that out of an overall consumption of 313 Mtec,¹ 210 Mtec were sheer loss and only 103 were real consumption; hence the overall efficiency came to no more than 33%. True, the enquiry bore on all energy users and not only on industrial consumers, but the lowest efficiencies are not always found in the industrial field.

This raises the question whether the efficiency in the use of electricity-consuming processes can be sufficiently high to counterbalance the initial disadvantage of this type of energy? Could this be possible on account of the wide variety of forms in which it may be used: Joule effect, Peltier effect, induction, electric arc, radiation (light, radio-electrical, infrared, ultra-violet, high frequency, hyperfrequency, etc.), electronic heating, magnetic field, electrical field, electrolysis, plasma and so on.

¹Mtec = million (metric) tonnes coal equivalent.

This variety and ease of control enable electric energy to be supplied where, as, when and how it is wanted. One may even give up supplying heat from the outside and have it nascent inside the product itself, as for instance by induction, by the Joule effect, by hyperfrequency, by friction, etc. For one can engender heat inside a liquid by friction, as for instance during ultra-fast sterilization; in a few tenths of a second, milk or fruit juice can be heated by means of a metal disk rotating rapidly inside a container with very little play between disk and container.

Are we sufficiently aware of the hopes now arising from current research on separation and concentration processes in membranes by reverse osmosis, or ultra-filtration, by means of mechanical energy of which the form most economical in primary energy is still the electric motor? For example, the treatment of one cubic meter of lactoserum through membranes to recover the protein requires only six kg of fuel oil equivalent, against twenty-five kg in a conventional evaporator. Also in the field of protein recovery, an experimental mechanical pressing of lucerne conducted in 1973 to reduce its water content from 90% to 50% (before processing it in an oven), used only seventeen KWh, equivalent to four kg of fuel oil, against twenty kg in a conventional oven to arrive at the same reduction of water content.

Further examples are: the numerous uses of heat pumps; the drying of polymerisable inks by ultra-violet rays; and the residual waters treatment by electroflotation and electro-flocculation. Innovations will invade more and more industries. Thus in organic electrochemistry, recourse to the action of electrons and protons inside molecules is envisaged: it could, for instance, lead to oxido-reduction reactions by means of brush discharges. Research in this is under way with collaboration between CNRS² and EDF.³ No wonder that, in such a framework, energy savings may be spectacular the moment one does not merely replace flames by resistors, but one has an entirely novel process through electricity.

²Centre National de la Recherche Scientifique (France).

³Electricité de France

But is there a way of assessing impartially the potential energy savings related to a given process? In the present economic and industrial context, moreover, can one be concerned solely with the concept of apparent savings in energy, without at least associating it to the concept of savings in raw materials?

Before coming to some more detailed--though as yet incomplete--examples of savings in primary energy by substituting new electrical processes for conventional ones, it is necessary to stress the points that the concepts of savings in energy and in raw materials--possibly even in labor and foreign currency--cannot be dissociated and that it is difficult to accurately assess the overall energy savings. This may be seen in the following example: Take two processes, both of them designed to melt aluminium, the first through a flame furnace, the second through a resistor oven, to make molded pieces. It requires about 1,500 thermies⁴ of fuel per metric ton of aluminium in a flame furnace to match the 600 kWh required by the electrical process.

If electricity comes from an oil-fired power plant, it will yield about 2.5 thermies per kWh. Thus both processes seem to be equivalent in terms of primary energy (1,500 thermies).

Let us go deeper into the matter: the first process may entail an additional loss by fire of 0.7% of the metal which is reduced from 1.4% to 0.7% in an electric furnace. To be valid, the comparison should entail the same amount of finished product. Naturally the additional 0.7% of thermies used in heating must be taken into account, but these ten thermies are negligible.

The point is that we have to produce the additional seven kg of aluminium. This needs, starting from the crude bauxite, an extra 50,000 thermies of energy--mechanical, thermal, electrical--per metric ton of metal, that is to say 350 thermies to arrive at

⁴The th/t/°C (thermie/tonne/degree C) = 1,000 kilocalories/metric ton/degree C = 2,240 BTU/long ton °F.

the seven kg required to make up for losses by fire. In this way one will expend 1,850 thermies per metric ton in the flame furnace against 1,500 thermies in an induction furnace. This will deeply modify an initial conclusion drawn from too limited an analysis of apparent savings.

Even leaving aside the economic aspect of saving foreign currency, or even labor, at least two objections may come into mind. They are: first, is not the reasoning incomplete by not taking into consideration the potential heat recovered downstream from the furnace? Second, is not this example too biased in favor of electricity, hence not generalizable?

To the first objection there can be a simple reply: the recovery possibilities must be carefully examined, because they can be very different. So, when replacing a flame furnace by an induction furnace, it may even be that recovery by cooling water from the coils is sometimes easier--and more profitable--than recovering the heat from smoke effluent, especially when reusing the heat for space heating (for one among the many problems of recovering down-graded heat is indeed to find the right needs close by: they must be of the same order of magnitude as the source, both in quantity of heat and in temperature level).

To the second objection--bias in favor of electricity--one could answer that this example is not the only one currently available, if one considers all of the fields of applications, for example:

- Thermocuring of concrete by electricity instead of by steam or hot water saves about 65% of primary energy, bringing the average consumption to forty-five liters of fuel oil per cubic meter of concrete (i.e. 450 th/m³) against sixty kWh per cubic meter (i.e. 150 th/m³)
- Drying of maize by dehydration with heat pump consumes twelve kWh per quintal, i.e. about 3.5 liters of fuel oil against 5.5 liters with a flame dryer;
- Wood drying by a similar process saves almost 50% of the primary

energy by cutting down the amount of fuel oil used from some forty liters per m^3 of dried wood, plus twenty-five kWh for ventilation (i.e. 460 th/ m^3) instead of 100 kWh/ m^3 (i.e. 250 th/ m^3);

- Reheating the temperature holding before forming of annealed steel billets in ovens producing a few tons per hour by means of conduction heaters entails a saving of 20% to 40%. Thus 1,300 thermies per metric ton consumed with conventional heating--including an additional 1.5% loss by fire--is brought down to 410 kWh (1,025 thermies) in an induction furnace and 300 kWh (750 thermies) in a conduction heater.

The basic question, however, remains: how to assess validly and impartially the energy savings involved in one of the two processes? Perhaps the few examples mentioned may have foreshadowed an answer.

First, an analysis must start from a common point in the two processes and end up with equal quantities of products able to give the same service. For instance, when reheating steel billets in order to make rods, calculations must begin in both cases with cold billets and end up with the same weight of rods of the same quality.

This is a relatively simple case, requiring only that one takes into account the energy available in the fuel, plus any supplemental consumption (which is often neglected), such as ventilation, or more generally motive force, minus the recovery of any potential heat. Another thing (which is often omitted) is to take into account the difference in losses by fire in terms of primary energy. This quantification of loss by fire must generally begin at the iron ore extraction phase (though in some cases it may be possible to recover calamine). Lastly it is necessary to convert the kWh into units or primary energy. This is one of the simplest examples to be found when the energy substitution is done by means of electricity.

But it is already far more complex if compared with the relative simplicity of substituting a gas flame for a fuel oil flame, although differences in the nature of their radiation may bring some problems regarding a correct appraisal of efficiencies. It is, however, im-

possible to neglect some factors that should be mentioned:

- Modifying the process may modify properties of the finished product. One must compare quantities of products giving the same service. For instance, induction heating treatment may allow the use of lighter parts (hence saving in materials) that wear out less rapidly (hence savings in materials and labor);
- Modifying the process may allow use of less noble or raw materials, or even less materials generally considered as pollutant. For instance, using electrical arc furnaces in mini-steelworks allows recycling of scraps, especially scrapped cars, at far less energy consumption than starting with fresh ore;
- Progress in the field of energy savings in some industries which did not worry about that up to now may sometimes be made in the area of conventional processes, based on older designs, more easily than with electrical processes; for these processes, energy saving has been a major preoccupation right from the beginning, if only for reasons of economic competitiveness. But in such existing plants the gains are scarcely likely to exceed 20%.

One problem requiring a great deal of attention is the conversion of kWh into units of primary energy. The general practice has been so far, when planning the development of electrical industrial processes, to assume a factor of 2.4 to 2.5 thermies PCS⁵ per kWh, as in Europe it is thought that any new application of electricity is to be now met by supply from oil-fired power plants throughout the year. This naturally does not hold for some countries, such as Switzerland, which draw most of their electricity from hydro-plants; in such cases, the correct physical conversion factor approximates some 0.86 thermies per kWh. The very existence of such a variation, which may reach a ratio of 1:3, will, in most of the industrialized countries, markedly affect the energy balance when comparing electricity to other types of fuel.

⁵PCS: pouvoir calorifique superieur or gross calorific value. Most users, however, figure in terms of PCI (pouvoir calorifique inferieur or net calorific value), which may entail a distortion of about 10%.

As things stand, in Europe and more particularly in France, a coefficient as high as 2.4 or 2.5 th per kWh⁶ will soon grow obsolete due to the massive arrival of nuclear power. Indeed, when the population of conventional thermal plants and nuclear plants has been reoptimized in terms of their respective operating costs, the conventional plants will operate for no longer than about 2,000 to 3,000 hours per annum. And their operating periods during peak hours will be virtually independent of the amount of regular consumption by the industrial users of electricity. It will then happen that virtually all of the industrial development of electricity will be based on nuclear energy. In France this will come about 1985, when the proportion of nuclear in the marginal kWh output will have risen from around 0% in 1980 to almost 100% in 1985.

There is a difficulty in determining a valid equivalent of nuclear energy in terms of primary energy. A simple and often repeated reasoning holds that since nuclear energy may be used either in the form of a hot fluid (e.g. steam), or in the form of electricity one has to penalize electricity by the efficiency factor of the conversion of heat into mechanical energy, so the equivalence factor could be something like $0.86 \times 3 = 2.5$.

But is this reasoning really similar to that generally used for liquid and gas fuels? In such cases the energy they develop during complete combustion is generally referred to. Logically, one should have to consider the theoretical heat given off by the fission of uranium 235. If the phenomenon merely involved the complete disappearance of the uranium, the situation would be similar

⁶Confusion is to be avoided between the equivalence factor in terms of primary energy with what might be called the coefficient of energy substitution. Thus in an above example, namely the pressing of lucerne, in which seventeen kWh were used instead of twenty kg of fuel oil (200 th), the substitution coefficient would reach 11.5 thermies per kWh. As opposed to the equivalence factor in primary energy (related only to the mode of electricity production), the substitution coefficient (related only to both the modes of using electricity and of using fuels in the considered processes) is all the more favorable to electricity as it is large.

to the disappearance of some conventional fuel; but in this case a new fuel is simultaneously generated from uranium 238 in quantities which may even exceed those destroyed by fission. So what could be the consumption of primary energy to be validly assigned to breeder reactors, other than possibly a negative consumption?

Without fully answering this question, it may be said that in energy balance sheets drawn up for facilities still operative in the 1985's, a coefficient of some 2.5 thermies per kWh will be pessimistic for electricity in most European countries. Some people are of the opinion that one might even equate the nuclear with the hydroelectric by assuming a coefficient of one or so.

But should not the question of savings be posed not solely in terms of energy and raw materials but above all in terms of outflow of foreign currency, especially in the case of the countries with an adverse trade balance? This would be eminently suitable, as naturally not all sources of primary energy have the same value in foreign currency. The comparison will always appear critical, and at least to begin with, will not be taken into account very often. But not doing so is liable to render the advantages of the electro-nuclear solution less obvious to some people.

Nonetheless, striving after the optimum use of energy and raw materials must, for some time at least, be the central preoccupation of citizens and industrialists. This in many cases may lead to seeking a combination of several energy sources--or more often, of several forms of utilizing a given form of fuel--each being used in its optimum range of efficiency. Let us again take the reheating of the steel billets before forming as an example: immersed in high-temperature gases, the colder the billets are, the more heat they absorb in a given time; and however great may be the flow of hot gases, billets cannot get hotter than gases are. Certainly there are other parameters to contend with, but this simplified approach will serve as reminder of the fact that the efficiency of a flame furnace is lower if the billets are hot. In current operation, the average efficiency equals that observed somewhere around 700°C.

As regards the efficiency of the electric process, induction heating is virtually independent of temperature. Losses by radiation increase with temperature, but there is a better penetration of the induction in the metal above the Curie point, namely above 700°C . There would therefore be a saving in primary energy if one used a flame furnace, or oven, up to about 700°C , and an induction furnace above this.

This kind of duplication is costly if the energy sources are as different as flame is from electricity. But in most cases a good energy balance will be obtained by combining many electrical processes, as for instance de-freezing, or drying, by coordinated use of radiation and heat pumps. No particular technical or financial problem will generally arise from such simultaneous installations.

To conclude, it is necessary to underscore the great care to be taken in intricate comparisons between a number of disparate processes, already developed or to be developed; to be emphasized too is the imagination that will be required from now on in order to introduce new industrial processes based on electricity.

It would go against the interests of the industrialized nations (and those of their industrialists) not to attempt to rise above the partial viewpoints to which they may have hitherto adhered. We have to opt from among a lot of scarcities: primary energy, raw materials, foreign currency. We must not focus, even temporarily, solely on savings in primary energy.

In fact, if prices of energy and raw materials properly reflected their true cost for a nation, the minimization of the discounted overall cost (investment plus operation plus maintenance) of the entire sequence of processes required for turning out the finished product would not be a debatable criterion. Is it valid to assume that true costs have been found again in Europe, after the disruption of the last months? It might be hazardous to affirm it, but this will come--perhaps soon. Meanwhile it is difficult to find a simple criterion not open to criticism.

The few examples selected here from a wide choice have shown that our legitimate striving to save primary energy and raw materials may already now be satisfied through the use of our available sources of electricity, the more so if such electricity may quickly and mainly be obtained from nuclear sources, or at least independently of hydrocarbon imports, whether liquid or gaseous.

But will industrialists worry about energy saving, and will they attune their investments to such a need? It scarcely seems likely that they will do so out of pure patriotism. There must be some financial incentive. This means that if we wish to achieve savings in energy and raw materials, we must show the industrialists not only the technical feasibility and reliability of the electrical appliances, but also the profitability of the processes and equipment we recommend for the purpose. This implies that we must be able to turn out mass produced equipment within a short time.

Furthermore, since speed is essential, this should foster international collaboration through an interchange of information among the various producers of electrical energy, manufacturers of equipment, and end-users. Undoubtedly, public authorities in the various countries should strive to induce innovative research on electrical processes.

Discussion

Sweeney

The presentation of Bouchet, Lencz, and Mount attempted to estimate the demand for one fuel outside of the context of the demands for other fuels. This of course is consistent with most of the work that has gone on in the past, where one studies the demand for electricity or for natural gas. It strikes me that since all of these fuels are close substitutes, it is very difficult to estimate the demand for electricity without focusing on natural gas and petroleum or coal as substitute products. Of course, one way to do this is to use prices or other characteristics of the substitute fuel as independent variables in the econometric analysis, but again some of the work going on in the US Federal Energy Administration suggests to us that this approach can be misleading.

One of the things we found is that it is fairly easy to "estimate" the demand function for any one fuel. The researcher has a great deal of latitude in choosing functional forms, independent variables and so forth. However, we also found that as soon as one starts estimating the demand for a fuel in conjunction with other demands one runs into some very difficult problems and often discovers some things wrong with the single-fuel estimates. While I am not suggesting that there necessarily are major difficulties with the studies presented here, I am suggesting these demand studies might usefully be placed in a context of other fuel demands.

In Bouchet's paper it struck me that he is correct in trying to struggle with the notion that you must look at combinations of various energy inputs rather than trying to translate everything to BTU's and to simply aggregate to BTU's of input. However, a problem arises when one assumes that prices are not correct because the price system can no longer be used for

aggregating inputs. I would have liked to see some discussion in that paper of how, since prices are rejected as aggregators, one goes about aggregating various inputs.

Waverman

This morning we have been told we are artists and not scientists and so I will not let Sweeney's remarks dissuade me from repeating some of the things he said to prove to you it is really science and not art. In Bouchet's paper I liked the first part very much; it reminds us that we must think in terms of output BTU's not input BTU's. If we consider efficiencies in transmission and conversion to final demand it is not necessarily true that electricity is the most inefficient of all fuels. Bouchet also tried to persuade us by giving us an implied social objective function which says that unless you have large amounts of indigenous oil you really cannot import any and therefore you need a lot of nuclear fuel. I object. I am not quite sure that electricity from nuclear plants will be cheaper in ten years as Bouchet suggested; the reverse could well be true.

Slesser

Bouchet raised the question of the energy efficiency of nuclear power stations. If you estimate the efficiency of a nuclear power station in terms of the fossil fuel used, you find it is an extremely efficient way of producing electricity. If you estimate it in terms of the fact that you are using up uranium which is no more than another form of stored heat then you come up with a different conclusion. As soon as you have breeder reactors uranium 238 becomes a fuel and you have not actually changed the efficiency; all you have done is vastly increase the stock and I wondered if Bouchet thought of it in the same terms.

Bouchet

At least in France it seems to be no problem to have "cheap" electricity by 1985. A recent study conducted for the Ministry of Industry and Research in France has confirmed this hope. We believe that, including no provision for inflation, electricity may stay at the same level of price from now till, maybe, 1979 or 1980. But we think there will be a net decrease from 1980 to 1985 and price of electricity in 1985 might be again roughly at the same level it was in August 1973 just before the oil crisis began.

Prognoses of the Consumption of Energy, Especially
Electricity: Methods and Experiences

Imrich Lencz

Introduction

Due to the constantly increasing demands of the energy sector on capital investments, on material means and on manpower as well as the continuously increasing densities of energy in relation to environment, forecasts of energy consumption are becoming increasingly significant. In Czechoslovakia, these forecasts occupy an important place in the research activity of a wide staff of research workers grouped around the Power Research Institute [2,4,5,6,8].

Numerical results are today utilized in a relatively wide scope both as a source of information for state authorities serving as basis for preparing the decisions as well as input data for mathematical models, mainly of the electric power system.

Forecasting future trends and events in a living dynamic system with continuous changes of the internal structure, of internal and external couplings, is always connected with difficulties and uncertainty. It is just due to this fact that the numerical results of the forecasts obtained by various methodological means often differ considerably, particularly in the case of distant time periods. Therefore, it seems useful to investigate the future demands for energy by several different methodological means. Besides the mathematical methods (extrapolation, one-dimensional and multi-dimensional correlations, mathematical models of electricity consumption development, etc.) we use the method of international comparison.

For more distant time periods attempts have lately been made with non-formalized prognostic methods based on a collectively undertaken expertise using a certain modification of the Delphi method.

Prognostic Methods in Use

Let us first consider the formalized prognostic methods. Apparently, two approaches should be distinguished within their scope:

- an approach in which we try to penetrate the internal structure, the internal and external relationships of the observed object, and explain the object's behavior by the functioning of these relationships; and
- a mathematical and statistical approach in which the object is looked upon as a black box.

The first approach is represented by the method of structural analysis. The authors from whose works the present report results [2,4,5,6,8] make use of this approach only to a limited extent, especially for expressing and analyzing the internal structure of the energy sector and mainly in considerations about supplying the industrial sector with energy. This approach proceeds from a relatively detailed description of the most important parts of the power system starting with energy sources, processes of refining and of transforming individual forms of energy, to the final consumption of energy.

More frequent are the mathematical and statistical approaches which regard the object as a black box and try to explain its activity on the basis of searching for the connections between individual elements of the observed trajectories. Three groups of methods used for this analysis should be linked with one another:

- 1) analysis of time series,
- 2) one-dimensional correlation, and
- 3) multi-dimensional correlation.

The analysis of time series is used as a basis for observing the past development of the object. Though, unfortunately, the individual mathematical functions may well characterize the past development and explain the fundamental (deterministic) component of the process, the extrapolation of the established future trends is very uncertain, and the respective mathematical function to be used for extrapolation must be chosen very carefully. As for the development of electricity consumption, numerous analyses revealed that three profoundly different time intervals can be defined in the long-term development of individual countries. The first corresponds to low values of the energy consumption per inhabitant and it is noted for a high share of the random factor, that is, for a considerable variation of annual increments. After having reached a certain value of the per capita consumption, the development becomes steadier and its trend is near to the exponential development. Annual increments are statistically stabilized and follow from the totality with normal distribution. Having achieved a certain development level (in our case about 1,500 kWh/capita/year) relative development gradually slows down and its extrapolation requires the utilization of functions with decreasing annual increments.

The regressive analysis of time series explains, as a rule, only the most important basic components of the development. Application of the correlation methods, in particular those of multi-dimensional correlation enable us to explain other regular residuals about the line of the trend. To a certain extent it also enables us to narrow the zone of consumption forecasts for more distant periods of time.

Using correlation methods we will try to bring into focus the influence of internal and external factors affecting consumption:

- a) demographic factors,
- b) economic factors,
- c) climatic factors.

The choice of explanatory variables becomes evidently different if we investigate the electricity consumption as a whole or the electricity and energy consumption by a group of consumers (e.g. of the population).

A further contribution for elaborating medium-term and long-term forecasts of electricity consumption is closely linked to the application of mathematical models which, making use of statistical functions, describe the relation between the electricity consumption and the social and economic development of the society characterized by a set of explanatory factors:

$$E = f(S_1, S_2, \dots, S_k) \quad .$$

In regard to a number of factors influencing the electricity consumption, the quantification of this correlation is greatly problematic but it is very important for the predictions and mainly for the possibility of controlling the further development of the electricity consumption in the desired sense.

In the first stages of constructing the mathematical model when uncertainties connected with the choice of explanatory factors are not yet removed, the most suitable type seems to be the linear form of the mathematical model:

$$Y = \alpha + \beta_1 X_1 + \dots + \beta_k X_k + u \quad ,$$

where

$Y = \psi(E)$ function of the electricity consumption development;
 $X_i = \psi(S_i)$ indices of the explanatory quantities;
 α, β_i = parameters of the equations;
 u_i = random deviation.

The chosen function ψ of the variables Y and X_i has to ensure the linear character of the relation between the explanatory variables X_i , as well as their mutual independence because the multicollinearity of explanatory quantities reduces the reliability of estimating the parameters α and β .

The evaluation of the accuracy and the sensibility of the model, the choice of explanatory factors and the stability of this correlation are made possible by tests of hypotheses concerning the significance of the values of β_i parameters in the past development. They may also be corrected after being compared with values obtained in other countries. By means of the model we may study the influence of changes appearing in the development of the individual factors upon the development of electricity consumption.

Another alternative exploitation of the described type of mathematical model involves the cases when, in addition to the explanatory factors S_i , we also make assumptions about the future electricity consumption. We may also verify the electricity consumption forecasts obtained by other methods.

In this activity we consider the fact that the forecast is not only a matter of passive event forecasting but that it is also, to a great extent, a matter of pointing out tasks for the realization of which a society should concentrate its means and power.

When comparing concrete forecasts it proved very useful to utilize a method of international comparisons, that is comparing expected development with that in other countries, mainly in those which have already attained a higher degree of economic development. A systematic work in this field has been done by Felix [3] whose results are also used in comparison forecasts of

energy and electricity consumption in our practice.

The longer the prognostic interval is the greater the uncertainty of the forecasts due to the lack of knowledge of the future structure of the energy sector, of the style of living, etc. Thus for more distant periods of time it may be useful to proceed, to a degree, also from the results of non-formalized methods (e.g. of a collectively undertaken expertise). An example will be described below.

A summarizing review of the characteristic features of the prognostic methods utilized in forecasting the consumption of electricity and of all forms of energy as a whole and when divided into the most important groups of consumers is given in Tables 1-4.

The figures describing the methods of forecasting the electricity consumption do not require detailed commentary. As far as the demand of all forms of energy is concerned we should like to point out that the forecasts at the level of the total gross energy consumption are not conventionally undertaken except for the method of international comparisons. The basis of forecasting the energy consumption consists mainly in forecasting the development of the final energy consumption by individual groups of consumers, but the mathematical methods of the type discussed above are mostly used in forecasting the final consumption in industry. In the case of other groups of consumers it is rather a matter of engineering-type balance studies with the exception of the household and municipal sphere where we proceed from a certain conception of the consumption pattern.

When solving this problem, the final energy consumption is split up into the following spheres (see Figure 1):

- manufacturing and construction,
- transportation,
- agriculture, and the
- non-production sphere.

Table 1. The main features of the method applied for forecasting the gross electricity consumption.

| | |
|--|---|
| <p>Extrapolation Methods</p> | <ul style="list-style-type: none"> - modified exponential line - k-transformation - Gompertz's function |
| <p>One-Dimensional Correlation Methods</p> | <ul style="list-style-type: none"> - correlation with population development - correlation with manpower development - correlation with total social product - correlation with fundamental means |
| <p>Multi-Dimensional Correlations</p> | <ul style="list-style-type: none"> - demography <ul style="list-style-type: none"> · number of inhabitants · labor force - economy <ul style="list-style-type: none"> · material consumption · formation of national product · means of production (machines) - climate <ul style="list-style-type: none"> · number of days with frost · degree days |
| <p>International Comparison</p> | <ul style="list-style-type: none"> - rates of growth depending on consumption per capita and year |
| <p>Collectively Undertaken Expertise</p> | <ul style="list-style-type: none"> - experts' estimates of main factors of electrification |

Table 2. Main features of the methods applied for forecasting the electricity consumption in different branches of the national economy.

Industry

| | | |
|--|--|---|
| Extrapolation direct and indirect extrapolation | One-Dimensional Correlation means of production gross production material consumption | Multi-Dimensional Correlation employment productive consumption national product fundamental means days with frost |
|--|--|---|

Transportation

| | |
|--|--|
| Extrapolation direct and indirect extrapolation | One-Dimensional and Multi-Dimensional Correlation length of electrified railways power capacity of the electric traction engines |
|--|--|

Agriculture

| | |
|--|--|
| One-Dimensional Correlation agricultural production | Multi-Dimensional Correlation employment fundamental means intensity of vegetable production intensity of animal production climatic conditions |
|--|--|

Household and Municipal Sphere

| | | |
|--|--|---|
| Extrapolation direct and indirect extrapolation | One-Dimensional Correlation population number of flats incomes of inhabitants | Multi-Dimensional Correlation number of households incomes of inhabitants household equipment climatic conditions |
|--|--|---|

Table 3. Main features of the methods applied for forecasting the energy consumption.

| | |
|---|---|
| International Comparison development of rates of growth depending on consumption per capita and year | Analytical and Balance Method summarizing balance of consumption basing on partial branch balances |
|---|---|

Table 4. Main features of methods applied for forecasting the final energy consumption of individual branches.

| | |
|-----------------------|-----------------------------------|
| Extrapolation Methods | direct and indirect extrapolation |
|-----------------------|-----------------------------------|

Correlation Methods

| | |
|----------|--|
| Industry | correlation with gross production correlation with fundamental means development correlation with population development |
|----------|--|

Balance Methods

| | |
|--------------------------------|--|
| Transportation | development of transportation structure specific energy consumption |
| Agriculture | specific energy consumption development of agricultural production |
| Household and Municipal Sphere | development of population development of the number of flats specific energy consumption development of individual transportation |

Structural Analysis

| | |
|----------|---|
| Industry | internal structure of the energy sector in relation to supplying the industry with energy |
|----------|---|

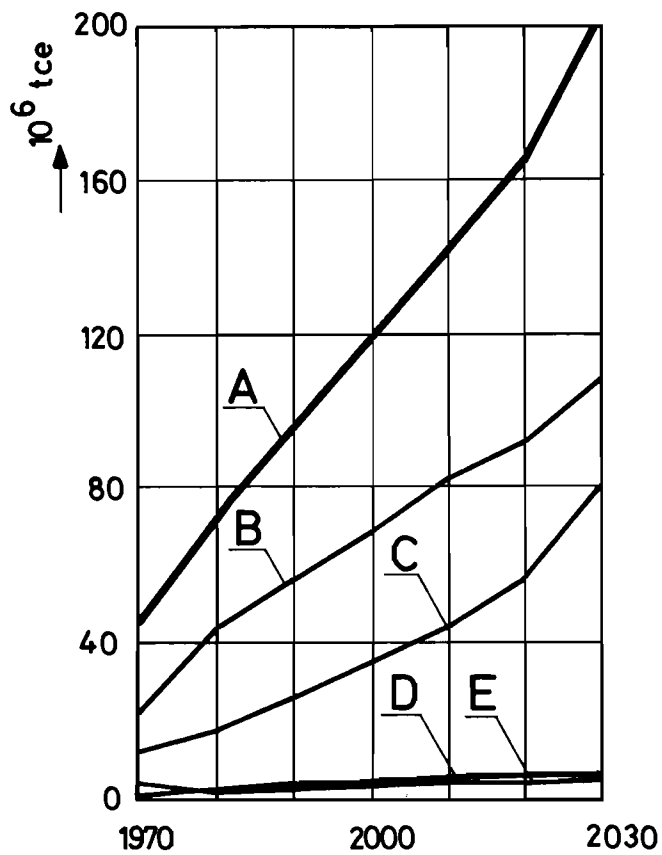

- A - TOTAL
- B - INDUSTRY
- C - NON-PRODUCTION SPHERE
- D - AGRICULTURE
- E - TRANSPORT

FIGURE 1. FINAL CONSUMPTION OF ENERGY
(AFTER [6]).

It appears appropriate to predict the development of the final energy consumption for all these consumption spheres independently with the aid of extrapolation, correlation, analytical and balance methods. Thereby the following main influences are assumed.

We arrive at acceptable conclusions by applying the correlation methods in the sphere of manufacturing and construction industries when the development of consumption is determined as a function of gross production, of the development of the fundamental means of production, of the number of inhabitants, etc. When further dividing the final energy consumption in this sphere we take into consideration the increased use of liquid fuels for some technologies and principally a progressive electrification of final consumption (see Figure 2).

The investigation of the development of energy consumption in transportation (not including individual transportation) requires relatively profound analytical work. It results from a successive retiring of the steam traction engines and their complete replacement by electric and diesel traction engines together with a simultaneous increase of the volume of road transportation. The substantial increase in the effectiveness of energy consumption in electric and the diesel traction engines (in comparison with steam traction engines) will exert a fuel-saving influence up till the end of the century and even bring about a decrease in final energy consumption in this sphere.

With respect to the limited fund of soil the most substantial influence affecting the development of the final consumption in agriculture is exerted by the intensification of agricultural production and by its mechanization. Mobile drives which are used in an ever wider scope need a sufficient quantity of liquid fuels. The last sphere of the final consumption in which we assume a fast development is the non-production sphere where several significant factors make themselves felt. On one hand there is a rising demand for comfort necessitating an increased number of flats, a decreased number of persons living in a single flat, an increased consumption of energy for heating, air conditioning, for water

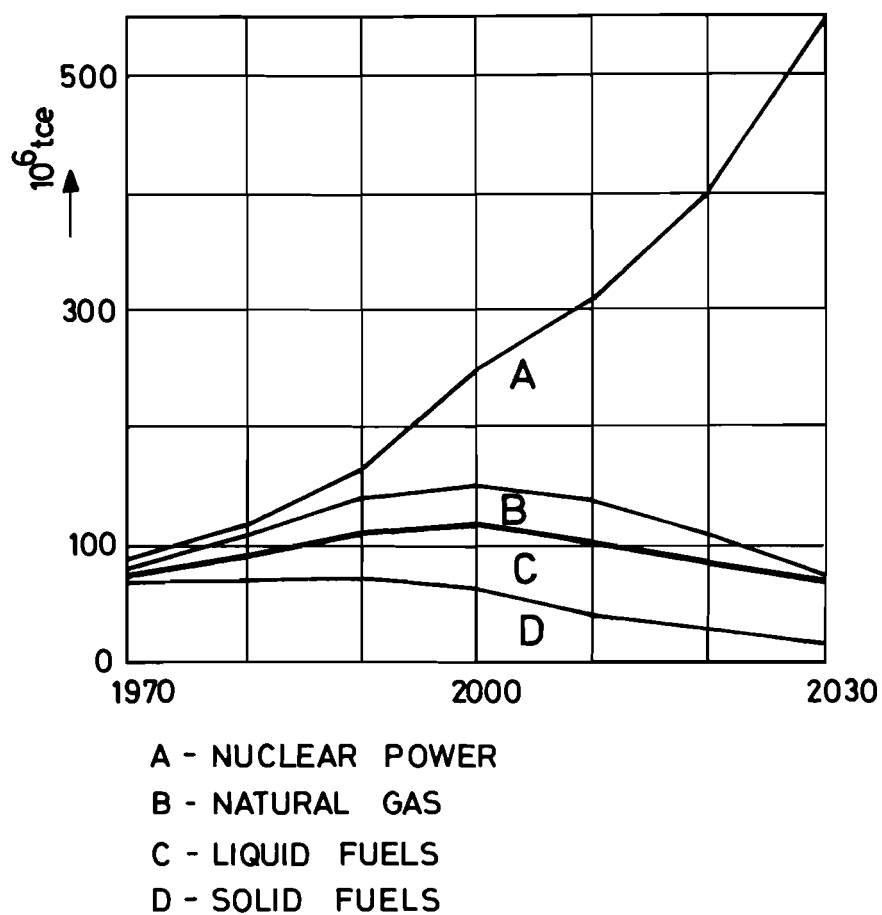

FIGURE 2. PRIMARY ENERGY SOURCES (AFTER [6]).

heaters and other thermal processes. On the other hand the development of individual transportation brings about high demands on liquid fuels (later probably on gaseous fuels and on electricity).

For this reason, the estimate of the development of the final energy consumption in individual branches under study also involves the investigation of the probable development of the final consumption structure respecting a certain interchangeability of individual forms.

Some Results and Experience

Electricity Consumption

Let us introduce some results of the forecasts obtained by the above-mentioned methods in order to illustrate some of their qualities and possibilities (Table 5) using statistical data to 1972.

The forecasts in Group A are given only for the purpose of comparison since the exponential development taken as basis of curve 1 is not typical for the attained level of the development. As a result of this we obtain too high values for more distant periods of time. On the other hand, the logistic curve did not prove good in the given case because its application leads to too low a point of saturation, as well as to very fast stagnation of development ($d = 103.2$).

Group B mentioned below illustrates some tendencies of the forecasts based on the extrapolation. The progressive decrease of annual relative increments is characteristic for curves 3-4; Gompertz's function used for elaborating the forecasts 6-7 possesses this quality for a certain combination of parameters and is characterized by a certain point of saturation. Curves

Table 5. Some results of the forecasts of electricity consumption in TWh/year (10^6 kilowatt-hours).

| Group | No. | Method | Year | | | | Note |
|-------|-----|-------------------------------|-------|-------|-------|-------|----------------------------------|
| | | | 1975 | 1980 | 1990 | 2000 | |
| A | 1 | exponential line | 70.5 | 106.8 | 129.9 | 562.0 | |
| | 2 | logistic curve | 62.8 | 75.3 | 91.9 | 99.1 | d=103.2 |
| B | 3 | modified exponential line | 68 | 93.2 | 170.7 | 306.4 | d=-10 |
| | 4 | K-transformation | 66.1 | 88 | 140.3 | 227.4 | k=0.3 |
| | 5 | parabola 2nd degree | 65.1 | 84.1 | 139.9 | 186.1 | |
| | 6 | Gompertz's function | 67.9 | 87.3 | 133.0 | 187.5 | series of 20 years |
| | 7 | Gompertz's function | 71.42 | 99.31 | 175.0 | 278.7 | series of 10 years |
| C | 8 | Felix's method | 68.93 | 92.83 | 154.6 | 235.3 | analytical interpretation |
| | 9 | correlation method | 68.0 | 90.4 | 147.4 | 220.3 | inhabitant, specific consumption |
| D | 10 | multi-dimensional correlation | 66.0 | 83.4 | 123.5 | 169.5 | |
| | 11 | multi-dimensional correlation | 68.2 | 88.2 | 135.4 | 192.3 | |

6-7 reflect the consequences of using the time series with different lengths; a shorter time series was used in curve 7 in order to eliminate some non-homogeneity of the original time series. A relatively great difference of results is characteristic for this group as a whole.

In Groups C and D we have mostly used the more complicated prognostic processes. Curve 8 is based on the analytical interpretation of Felix's prognostic curves by means of Gompertz's function while curve 9 results from the forecast based on the correlation between the development of the number of inhabitants, the electric consumption per capita and year and the total electricity consumption.

Group D is based on the multi-dimensional correlation and we examine the influence of the specific value of forming the national product per capita (p) and that of the specific material consumption referred to a unity expended on a unity of the national income in two possible cases of the development of the explaining factors.

It seems that the application of autonomous forecasting methods (independent of the development of other factors) leads, in general, to higher development trends than the application of methods based on the development of economic indicators, even when choosing the functions with a successive suppressing of development tendencies. In addition, the application of more complicated methods with a higher number of explanatory factors enables one to narrow down the zone of future development forecasts. It may be assumed that the construction of more complicated models--which is by no means a trivial matter--will result in the increased reliability of forecasting.

The analysis of the preceding conditions reveals that the consumption of electricity is to a high extent inversely related to the attained rate of developing the electric power system's generation basis. In the prospective view, this fact leads to the

construction of a model based on describing the development of demand and of supply. A model which could reflect the influence of limitations affecting the development of the electric power system (available investment or also manpower) is also considered.

The Delphi Method

To form a more precise conception of the long-term development of the electric power system, we have lately made an attempt to use the method of a collectively undertaken expertise, that is one of the modifications of the Delphi method. The method was oriented to the evaluation of a wider scope of prognostic problems but we shall present only those results which concern the development of the consumption of electricity and heat.

The basic features of the applied procedure were the following: the use of questionnaires, anonymous collective work, iterative sharpening of results, evaluation of the experts' qualifications and a statistical evaluation of the obtained answers.

The group of about thirty-five experts were given in advance prepared questionnaires including multiple-choice answers. In the first stage the expert chose a certain variant for each answer and, at the same time, he evaluated his own qualifications to answer the given question by using a scale from 0 to 4. The next stage was more objective in evaluating the qualifications of the experts and used the following main criteria: age, scientific degree, published works in the given field and on other subjects, scientific and organizational activities, functions, activity in international organizations, knowledge of foreign languages, sources of professional argumentation, etc. The highest attainable qualification was evaluated by a mark of 10.

In the second stage the expert worked also with alternative answers but he had been acquainted with the prevailing answers from

the first stage of work. The stability of opinions was evaluated statistically.

In the domain of the energy consumption we have examined two groups of questions. The first group of questions was concentrated on the consumption of electricity and the second on the consumption of heat. Let us present some results.

Consumption of Electricity

The qualifications of the experts to convey their opinion of this group of questions ranged from 4.55 to 4.72.

According to collective opinion, the Czechoslovak electric power system will attain the consumption level of 30,000 kWh/capita/year in the twenties of the next century. This answer is attained with a stability of opinion of 43.6%. This consumption will approach the inflex point of the development curve (stability of opinion, 50.3%). At this level of electrification representing about 600 TWh/year the non-production consumption will amount to about 50% (stability of opinion, 48.5%) while the share of the automatized manufacturing processes in the whole productive consumption will attain about 50% (stability of opinion, 66.7%). It is assumed that at that time a high share of consumers-controllers (stability of opinion 75.7%) will permit a marked equalization of the load curve in the electric power system.

Consumption of Heat

The mean qualification of experts in this group of questions was estimated by a lower mark of only 3.41-3.31%. According to the experts' collective opinion the heat generated in atomic power plants and electric heating will participate in the heat supply in the given prognostic period. The heat generated in atomic power

plants would be used in the plants' proximity (stability of opinion, 90.8%) and the remaining demand for heat will be covered by electricity used as a secondary source of energy (stability of opinion, 99.1%).

It should be pointed out that the answers obtained have a statistical character which must be respected. The results cannot unambiguously confirm or exclude a certain alternative; they can therefore be taken only as a correction factor for the orientation of prognostic considerations.

Many methodological questions about this procedure are not completely solved. The statistical means for evaluating the statistical significance of alternative answers are not sufficiently elaborated mainly in the fact that the behavior of the expert may not be considered as random. The analysis of the results of the experiment enabled us to recognize a relatively high internal dependence of certain groups of experts.

We intend to undertake a further elaboration of this method in the near future, and, after obtaining the fundamental information, we are going to work with a subpanel of experts.

Energy Consumption

As for the consumption of all forms of energy we may mention two prognostic results for comparison reasons. One of them was obtained based on the results of the international comparison using Felix's curves. The analysis of the preceding curves revealed that the development in Czechoslovakia varies about the value of 101.5% of the world median. By means of the above curves we have obtained the first forecast given in Table 6. The second forecast was obtained by using the procedure described in the foregoing chapter of the paper, that is by means of analyzing the development of the final consumption in the particular branches in view of the progressive electrification of energy balance and of the development of volumes of the processes for refining and transforming the energy.

Table 6. Consumption of energy in 10^6 tce.

| | 1980 | 1990 | 2000 | 2030 |
|-------------------------|-------|-------|-------|-------|
| Felix's method | 126.1 | 168.8 | 222.1 | 452.9 |
| Method according to [6] | 119.6 | 176.6 | 249 | 554 |

For the interval of time till the end of the century the forecasts obtained by using both methods are sufficiently close. A more distinct difference can be found in the results for the year 2030. This is probably due to the fact that, while Felix's curves are based on a certain natural and continuous development of the developed energy economies, the second forecast reflects the influence of exhausting the fossil energy sources and, for this reason, also the intensive electrification of the balance accompanied by a fast increase of the total demands on primary energy sources.

Conclusions

This concise report can hardly give a comprehensive view of all aspects of the activity undertaken by the Power Research Institute in the field of forecasting the consumption of energy. It should be noted that further attention is drawn to the random component of the forecast, as well as to seasonal and cyclic components which are of importance for more detailed considerations involving the reliability of the energy supply, the accumulation of energy, etc. The present-day work is prospectively oriented toward the investigation of the uncertainty of forecasts with the aim of using the obtained information for preparing decisions under conditions of uncertainty for future developments, and toward the elaboration of more compact models for forecasting all forms of energy.

The author wishes to thank Mrs. D. Stěničková, Mr. P. Erban and Mr. F. Lidický for their kind help when elaborating this report, as well as Mr. K. Šotek for linguistic assistance.

References

- [1] "Annual Bulletin of General Energy Statistics for Europe." United Nations, 1-4 (1970-1973).
- [2] Erban, P. "Investigation of the Application of a Collectively Undertaken Expertise Evaluated by the Delphi Method." In Czech. Research Report EGÚ. Prague, 1975.
- [3] Felix, F. "Analysis of Recorded Use and Growth of Energy and Electricity: Improved Method of Forecasting Future All Countries of the World." Paper No. 8L. Tokyo, WPC, 1966.
- [4] Freiburger, R. "Verification and Improvement of Some Methods of Medium-Term and Long-Term Forecasting of the Electricity Consumption". In Czech. Research Report EGÚ. Prague, 1973.
- [5] Lencz, I. "Prediction Methods to be Used in Optimizing the Development and the Operation of the Electric Power System by the Methods of Mathematical Modelling." In Czech. CVUT, "Prognostic Methods in the Power Engineering." 1974.
- [6] Lidický, F. et al. "Forecast of Consumptions of Energy of the CSSR and Their Coverage of Sources up to the Year 2030." Works of EGÚ. Prague, 1975.
- [7] Statistical Year-Books of the CSSR. Prague, SNTL.
- [8] Stěničková, D. "Long-Term Prognosis of Electricity Consumption in Relation to the Social and Economic Development of Czechoslovakia." Paper No. STO/SYMP/EP/A.3, Symposium EHK. Stockholm, 1972.
- [9] "World Energy Supplies." United Nations Statistical Papers, Series J, No. 15.

DiscussionSweeney

I was rather impressed listening to Lencz's presentation. It seems like a very sensible way to estimate the demands for various fuels. He has chosen a number of alternative procedures and, not surprisingly, he has found that each procedure gives a very different estimate of the demand for energy in 1985. One question I ask is: Now what? How do you then start taking these various demand estimates, which vary over a 2:1 range and come to something more comprehensive? I am also concerned that there were no comments on incentive structure. Although Lencz is dealing with a planned economy, individuals can still choose how much electricity they wish to use for various functions. It seems to me that including some notion of the incentive structures in the econometrics would be useful. For example, the use of shadow prices as independent variables in the regression may prove useful.

Waverman

I join Sweeney's question: Which one of those forecasting methods do you pick, when you have five possible methods? Which of those forecasts do you use as the basis for policy and how do you forecast your exogenous variables? If you are using the same range of techniques for those as you are for energy then you have five times five or twenty-five possible forecasts. I am not sure how all that would work and I would like to see some kind of adaptive mechanism--learning from what has happened in the last few years--so that if you are wrong the model can pick that up even if it is only a kind of Box-Jenkins time series extrapolation. In terms of Delphi techniques, I have never been impressed by these. I would like to use that survey technique today in this room on the price of oil in 1980 and see the conclusions on that.

Lencz

Delphi results are used only as a corrective factor for better orientation. They have a statistical character, and they cannot confirm or exclude a certain alternative. As for the results of forecasts, before using them, they are discussed and evaluated with a wide group of experts. The final product is a result of their decisions. We feel that the scope of the electric power system will not be sufficient for electric energy forecasting. The way to construct more comprehensive models of the energy systems is to respect this interchangeability of individual forms of energy.

Effects of Increasing the Use of Electricity on Environmental
Quality in the US: A Model of Power Generation and
the Policy Issues Raised by Its Application

T. D. Mount and L. D. Chapman¹

Introduction

In 1974, the total quantity of electricity generated by the utility industry in the US was almost the same as it had been in 1973. This represented a dramatic departure from the experience of the previous twenty-five years, as generation levels had grown steadily at an annual rate of about 7% from the end of World War II up to the early 1970's. A major question now facing the electric utility industry is whether the level of generation in 1974 reflects a temporary phenomenon brought about by the economic recession and by a public response to the "energy crisis," or a more substantial change in certain factors which influence the quantity of electricity demanded. This question is addressed in the first part of our paper through the use of an econometric model of the demand for electricity.

In response to the recent large increase in the price of imported oil, government officials have considered various measures for reducing the quantity of oil imported. Such measures are typified by the Project Independence Blueprint²

¹The authors are Assistant Professors of Agricultural Economics at Cornell University, New York, USA. This research has been supported by The College of Agriculture and Life Sciences at Cornell University. Earlier research was conducted in cooperation with The Oak Ridge National Laboratory, Tennessee and funded by the National Science Foundation RANN program. The authors wish to thank M.M. Slanger and J.K. Baldwin for their contributions to the preparation of this manuscript.

²Federal Energy Administration, "Project Independence Blueprint: National Energy Demand Forecast," draft (August 1974).

published by the Federal Energy Administration in 1974. The substitution of electricity, generated from coal or nuclear fuel, for oil and natural gas is one obvious policy alternative. However, the successful implementation of such a policy could have serious environmental consequences. In the second part of this paper, one of the major problems associated with increasing the generation of electricity from coal is investigated, namely, its effect on the levels and regional distribution of the emissions of sulfur oxides. There are two parts to this analysis. First, the consequences of increased levels of sulfur oxides on health are predicted, and here we draw entirely on the work of J.F. Finklea, G.G. Akland, R.I. Larsen and W.C. Wilson at the National Environmental Research Center in North Carolina. Second, we consider alternative government policies for enforcing standards on the levels of sulfur oxides emitted by electric utility companies. The consequences of these policies on health and on the quantity of electricity demanded are then predicted. For the latter prediction, the cost of controlling the emission of sulfur oxides is assumed to be passed on to customers in the form of higher prices for electricity. A more detailed account of this analysis is contained in a report prepared by the Task Force on Conservation and Fuel Supply for the National Power Survey. The report will be published in the near future by the Federal Power Commission.³

Finally, the general implications of our results for government policies toward the production of energy and the quality of the environment are discussed. We conclude that there has been insufficient emphasis on measures for influencing

³L.D. Chapman, G.G. Akland, J.F. Finklea, R.I. Larsen, T.D. Mount, W.C. Nelson, D.C. Quigley, and W.C. Wilson, "Power Generation: Conservation, Health, and Fuel Supply," draft, a report to the Task Force on Conservation and Fuel Supply, Technical Advisory Committee on Conservation of Energy, 1973 National Power Survey, US Federal Power Commission.

the demand for, as opposed to the supply of, energy. To illustrate this point, an attempt is made to determine the consequences of modifying existing rate schedules for electricity by charging the same price to all classes of customers and to all customers within each class.

Forecasting the Demand for Electricity

At fairly regular intervals, the Federal Power Commission conducts a National Power Survey. One aspect of this survey has been the aggregation of forecasts presented by individual utility companies to nine different National Electric Reliability Councils (NERC) representing specified regions in the US. The aggregate forecasts for the US published by the NERC in 1973⁴ and in 1974⁵ are summarized in Figure 1 together with the actual levels of generation for the years 1965 to 1974.⁶ The forecast made in 1973 is effectively an extrapolation of the past growth rate (since the vertical scale is logarithmic, a straight-line forecast corresponds to a constant rate of growth). However, the unexpectedly low levels of generation experienced since the latter part of 1973 resulted in a revision of this forecast. The forecast made in 1974 has almost the same slope as the earlier forecast, but it is slightly displaced to the right. This implies that the reduced growth rates of generation were interpreted as a temporary aberration. A "normal" growth rate was expected to resume after a delay of

⁴Federal Power Commission, "Utility Fuel Requirements, 1974-2000," draft, Task Force on Utility Fuels of the National Power Survey, 1973.

⁵Federal Power Commission, FPC News, 7, 26 (June 28, 1974).

⁶Edison Electric Institute, Statistical Year Book, 1965-1973, and Survey of Current Business.

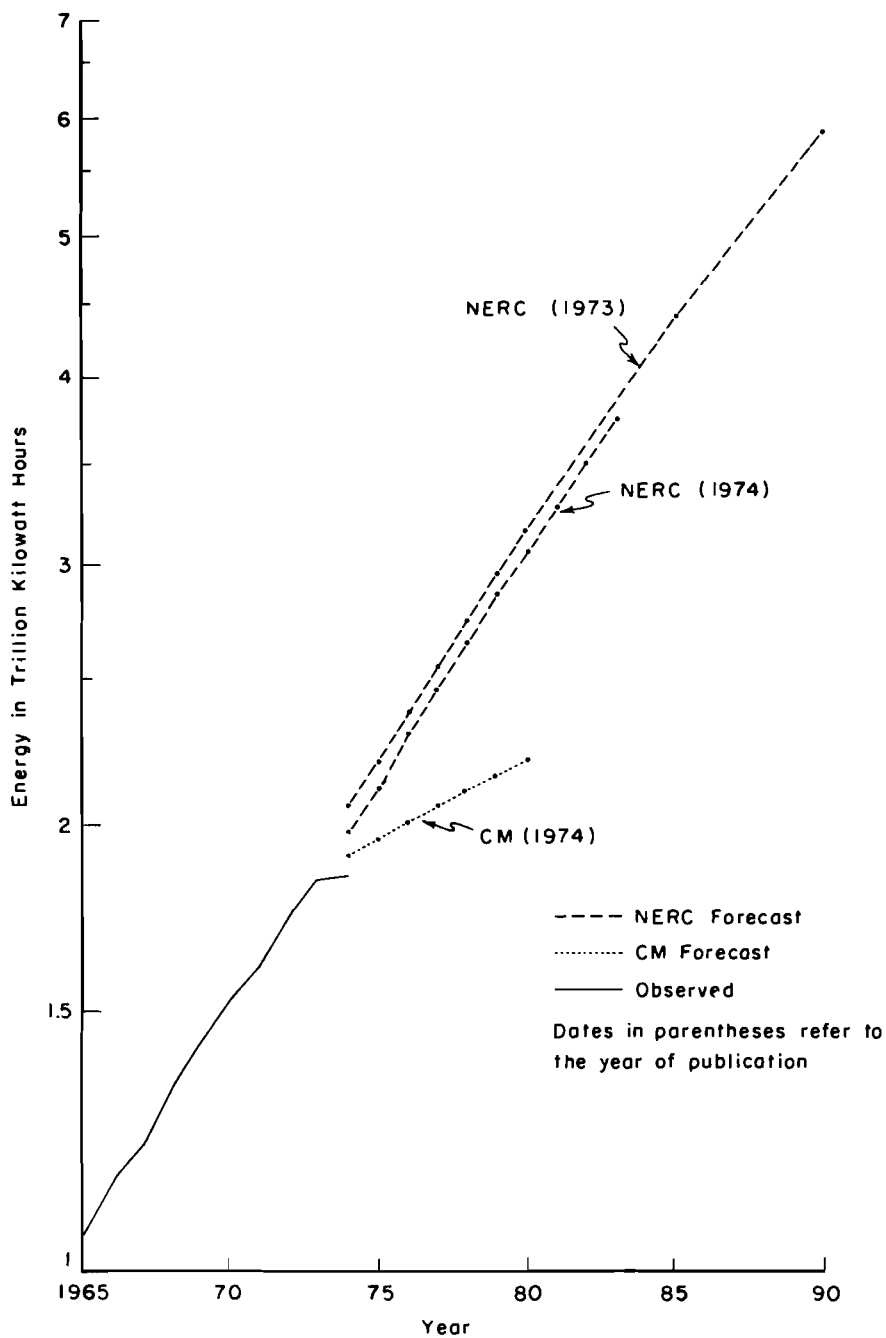

Figure 1. Annual generation of electricity in the US (forty-eight contiguous states).

one year. However, things have still not returned to "normal" in most parts of the country, and as a result another forecast has been prepared by the NERC. Although this forecast has not yet been published by the Federal Power Commission, the main conclusion is that the anticipated growth rate for the industry as a whole will be somewhat lower than the rate previously forecast.⁷ This suggests that some long-term changes in the behavior of the demand for electricity have been recognized by some companies. A similar chain of events is clearly illustrated by the three forecasts published in 1973, 1974, and 1975 by the New York Power Pool (NYPP).⁸ These forecasts are presented in Figure 2 together with the actual levels of generation in New York State from 1965 to 1974.

One objective of our research during the past four years has been to estimate econometric models of the demand for electricity, and to use these models to forecast future levels of generation of electricity in the US. In these models, the quantity of electricity demanded is related to various economic and demographic factors, and the magnitudes of the relationships for each factor are estimated from observed levels of the factors and the corresponding quantities demanded. There are four characteristics of our models which are important for forecasting purposes. These are:

- 1) The models are estimated for three different classes of consumer which together account for about 95% of total sales. Many studies consider only the residential sector which represents about 30% of sales.

⁷Private communication with Dan Lewis, Director of the National Power Survey, Federal Power Commission.

⁸New York Power Pool, Annual Report Pursuant to Article VIII, Section 149-B of the Public Service Law.

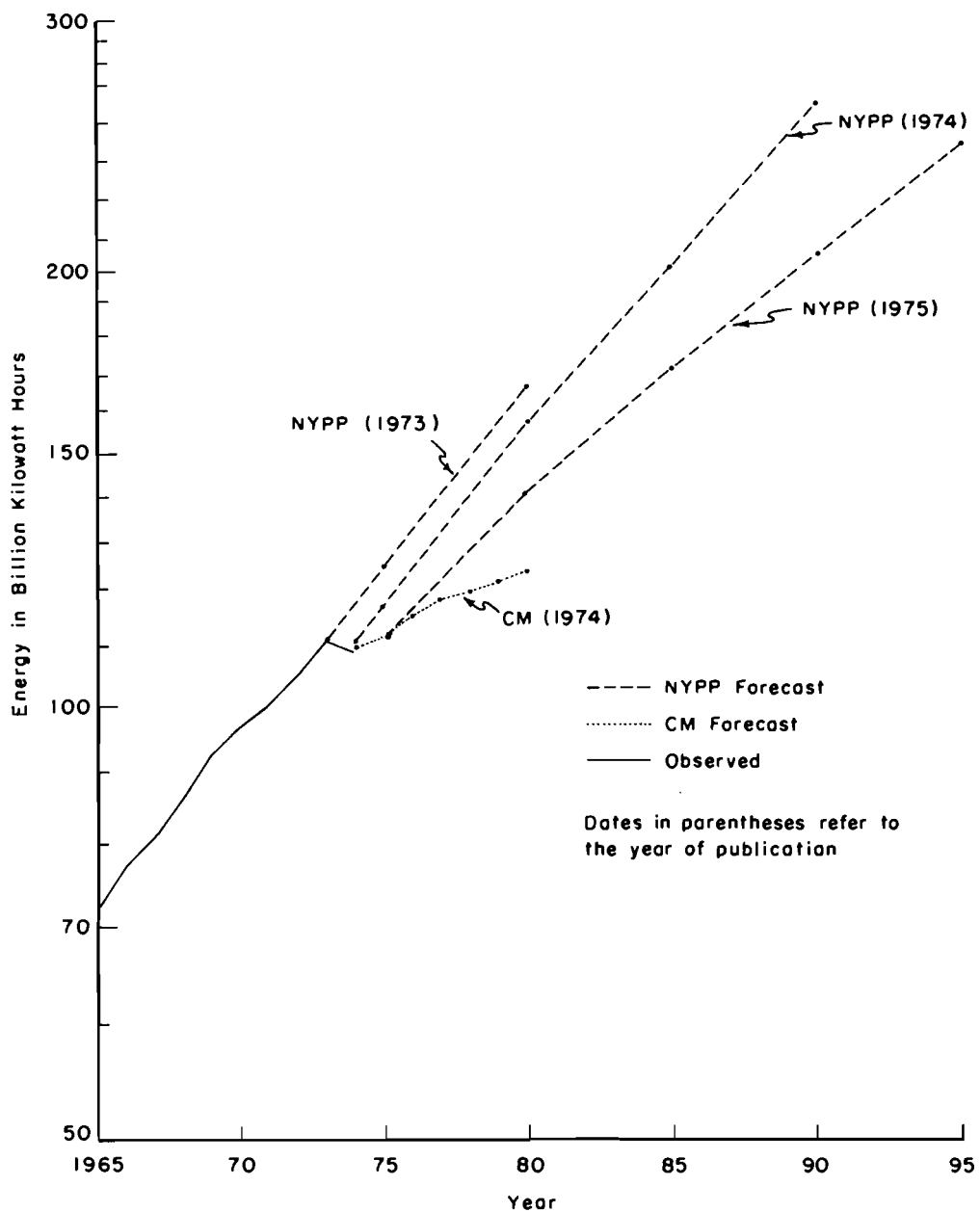

Figure 2: Annual generation of electricity, New York State.

- 2) Each model is dynamic to allow for the gradual adjustment of demand to changes in any of the explanatory factors. This adjustment process reflects the inevitable delays in modifying existing stocks of electrical appliances and machinery, and it is an important feature of demand for predicting the short-run effects of different policies. This process is generally ignored in models which are estimated exclusively from cross-section data.
- 3) The prices of substitute fuels such as natural gas, oil and coal are included as explanatory factors. In spite of the obvious importance of substitution effects on the demand for electricity, the only price used in some studies is that of electricity.
- 4) Since the data used for estimation are for individual states in the US, it is possible to do a relatively detailed analysis of the effects of alternative policies, particularly those relating to environmental issues, on different regions. Models estimated from national data are less suitable for such analyses.

A separate single equation model for the residential, commercial and industrial sectors is estimated from pooled cross-section (the forty-eight contiguous states) and time-series (the years 1963 to 1972) data. Each model is linear in logarithms, and a partial adjustment mechanism (a distributed lag with geometrically declining weights) is specified. Random cross-section effects are included, and an approximate generalized least squares estimator is used. A more detailed account of the models and the estimation procedure is presented in the Appendix.

The important features of the estimated models are summarized in Table 1 in terms of the long-run elasticities

Table 1. Estimated long-run elasticities¹⁾
of demand for electricity.

| Explanatory Factor ²⁾ | Class of Customer | | |
|---|-------------------|------------|------------|
| | Residential | Commercial | Industrial |
| 1. Number of Customers | 1.01 | .92 | .65 |
| 2. Income per Capita | .61 | .23 | .32 |
| 3. Price of Electricity | -1.17 | -1.22 | -1.00 |
| 4. Price of Natural Gas | .03 | .00 | .00 |
| 5. Price of Oil ³⁾ } | .61 | .64 | .09 |
| 6. Price of Coal ³⁾ } | | | .11 |
| 7. Price of Electric Equipment | .00 | .00 | -.16 |
| 8. Gross National Product ⁴⁾ | - | - | .50 |
| Percentage Adjustment Occurring in the First Year | .27 | .45 | .27 |

1) The long-run elasticity is the percentage change in the quantity demanded after all adjustments have been completed in response to a 1% increase of an explanatory factor (all other factors remain constant).

2) All variables measured in dollars are deflated.

3) The prices of oil and coal are combined into a single index for the residential and commercial sectors.

4) Income per capita is a measure of affluence within each state, whereas the gross national product is a measure of national affluence.

(defined in Table 1) for each of the major explanatory factors. A number of other factors included in the models for estimation purposes are not discussed here (see Appendix). The price of electricity is found to have the largest elasticity in all three sectors, followed by the number of customers (reflecting the size of the population). Income and the prices of substitute fuels have relatively small elasticities, although in the industrial sector, the elasticity for the gross national product enlarges the overall effect of income. It is, however, rather surprising that the estimated elasticities for natural gas are so low in all sectors.

One important implication of the elasticities presented in Table 1 is that the price of electricity is a major determinant of the quantity of electricity demanded. Consequently, the growth of demand up to the early 1970's can be partly explained by the decrease which occurred in the price of electricity, relative to the prices of substitute fuels and to the general level of prices, as well as to increasing population and affluence. Since similar price decreases are not expected to occur in the future, a reduction in the growth of demand for electricity may be anticipated. Increasing prices of substitute fuels tend to offset this effect, but lower growth rates for population and real income will also contribute to a reduction in the growth of the use of electricity.

The actual level of electricity demanded depends on the combined effect of all of the explanatory factors. Forecasts can only be made if the levels of these factors are specified. To illustrate this procedure, recent forecasts of the explanatory factors were taken from various sources (see footnote three above), and the corresponding growth rates for each factor are summarized in Table 2. This information provides a basis for forecasting the sales of electricity for the three consumer classes in each state. The sum of sales in

Table 2. Growth rates of the explanatory factors used to forecast generation.

| Explanatory Factor ¹⁾ | Annual Growth Rate ²⁾ |
|---------------------------------------|----------------------------------|
| 1. Number of Customers ³⁾ | 1.4% average ⁴⁾ |
| 2. Income per Capita | 2.9% average ⁴⁾ |
| 3. Price of Electricity | 5.0% |
| 4. Price of Natural Gas ⁵⁾ | 7.0% |
| 5. Price of Oil ⁵⁾ | 9.0% |
| 6. Price of Coal ⁵⁾ | 7.0% |
| 7. Price of Electric Equipment | 0.0% |
| 8. Gross National Product | 4.0% |

1) All variables measured in dollars are deflated.

2) The base year is 1972.

3) Assumed to be proportional to population.

4) These rates vary between states, and are taken from the bureau of economic analysis.

5) These rates are derived from a study of the availability and prices of energy conducted at the MIT Energy Laboratory.

the three sectors is then converted to the total generation of electricity by assuming that the ratio of generation to the sum of sales remains the same as the value observed in 1972 in each state. Forecasts of the generation in each state can then be aggregated to the regions covered by the NERC or to the national level. The exact regions covered by the NERC are shown in Figure 3.

In Table 3, forecast levels of generation for 1980 derived from our models (CM) are presented together with the corresponding forecast published by the NERC in 1973. In addition, actual levels of generation in 1972 are included for comparative purposes. Obviously, our forecast for 1980 is considerably lower than the level forecast by the NERC. Comparing the nine regions, the increases of generation from 1972 to 1980 range from 70% to 105% for the NERC's forecasts, but range from 16% to 38% for our forecasts. This difference is also illustrated in Figures 1 and 2 for the US and for New York State. Our forecasts, which are very similar to earlier forecasts which we published in 1972,⁹ are much lower than any of the various forecasts made by the NERC or by the NYPP. Although one can argue with the accuracy of the estimated elasticities in Table 1 or with the plausibility of the growth rates in Table 2 and hence with our specific forecasts, the results of other econometric studies of the demand for electricity generally imply conclusions similar to ours. Consequently, we believe that the growth rates for generation currently planned by the utility industry are in general unrealistically high.

Even though some electric utility companies use econometric models for forecasting purposes, many members of the industry are openly skeptical of forecasts which are lower than their own. One criticism which is often raised is that models estimated from data collected during a period in which

⁹L.D. Chapman, T.J. Tyrrell, and T.D. Mount, "Electricity Demand Growth and the Energy Crisis," Science, 178, 4062 (November 1972), 703-708.

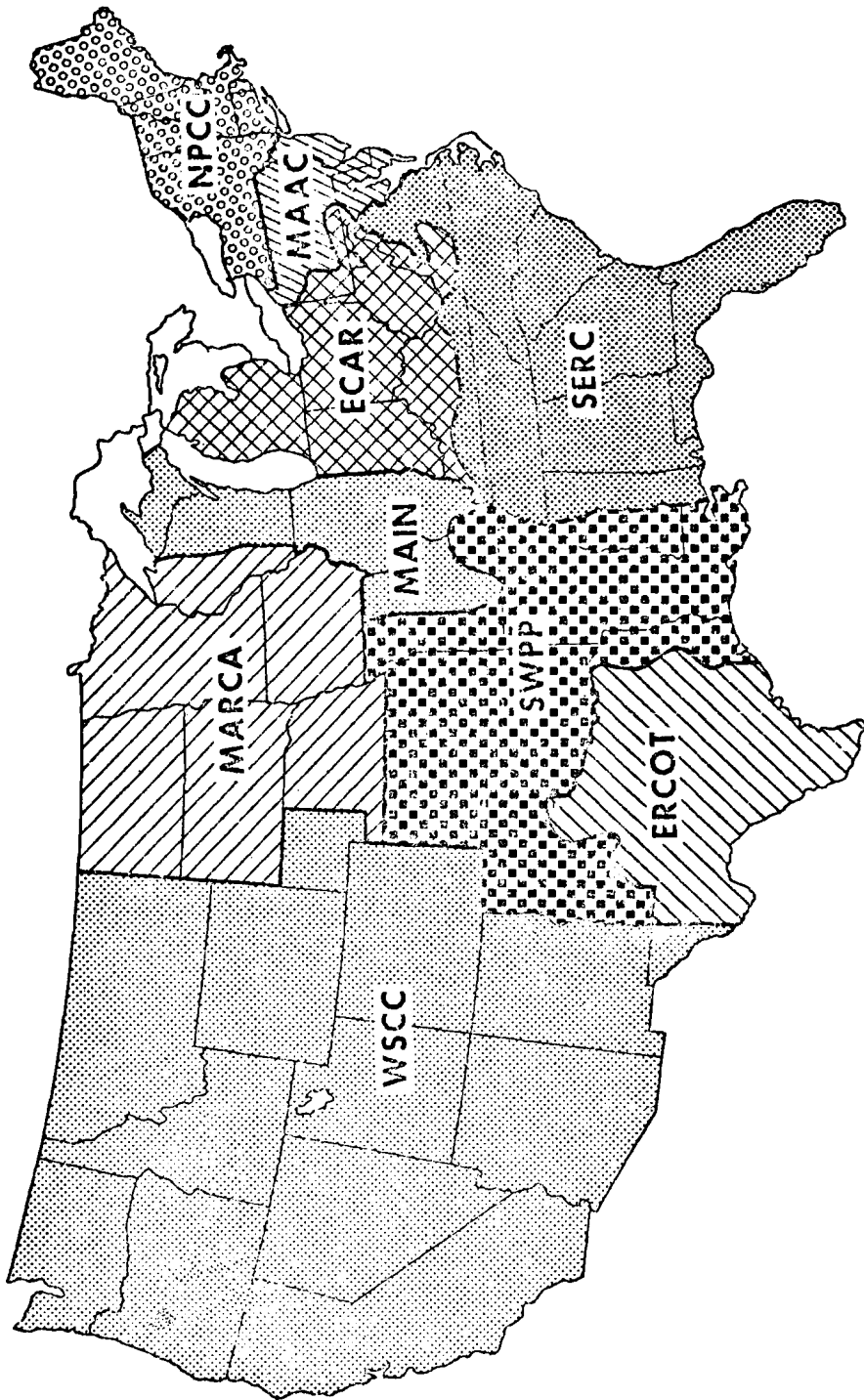

Figure 3. Regional electric reliability councils.

Table 3. Alternative forecasts of the generation of electricity in 1980.

| Region | Generation in Billion Kilowatt Hours | | | Percentage Increase | |
|----------|---|--------------------|------------------|---------------------|----|
| | Observed Level in 1972 ¹⁾ | NERC ²⁾ | CM ³⁾ | From 1972 | |
| | | | | NERC | CM |
| 1. NPCC | 170.2 | 295.3 | 207.4 | 74 | 22 |
| 2. MACC | 140.7 | 259.9 | 162.8 | 85 | 16 |
| 3. SERC | 350.0 | 718.6 | 450.6 | 105 | 29 |
| 4. ECAR | 308.0 | 522.8 | 378.3 | 70 | 23 |
| 5. MAIN | 129.8 | 229.4 | 159.8 | 77 | 23 |
| 6. SWPP | 137.7 | 273.5 | 182.3 | 99 | 32 |
| 7. ERCOT | 106.1 | 203.5 | 146.4 | 92 | 38 |
| 8. MARCA | 62.2 | 116.3 | 78.0 | 87 | 25 |
| 9. WSCC | 330.4 | 566.8 | 445.1 | 72 | 35 |
| Total | 1,735.1 | 3,186.1 | 2,210.7 | 84 | 27 |

1) The regional breakdown for 1972 was prepared by William Balet, Federal Power Commission.

2) Published in 1973.

3) Published in 1974.

the real prices of electricity were falling are unreliable when prices are increasing. Since data exists for periods in which prices have increased, an attempt was made to determine whether demand responded in an unusual way to these increases. It should be noted that data for 1974 are not yet published, and data for 1973 are still being processed, and consequently, it will be interesting to repeat this type of analysis when newer data are available.

The specific objective is to determine whether the magnitudes of the relationships for individual factors are influenced by price increases. It is assumed that the long-run characteristics of demand are unchanged, implying that customers have a stable view of their long-run goals, but the path of adjustment and the short-run relationships may be affected.

The partial adjustment model used in our analysis may be characterized by two expressions. To simplify the notation, only a single explanatory factor is explicitly identified, and with this simplification, the two expressions may be written

$$Y_t - Y_{t-1} = (1 - \lambda)(Y_t^* - Y_{t-1}) \quad ,$$

$$Y_t^* = \alpha + \beta X_t$$

where

- Y_t is the actual level of the dependent variable (logarithm of quantity demanded) at time t ;
- Y_t^* is the desired, but unobserved, level of the dependent variable, and $(1 - \lambda)$ is the proportion ($0 \leq \lambda \leq 1$) of the adjustment toward the desired level which is actually attained;

X_t is the level of the explanatory variable (e.g. logarithm of income), and β represents the long-run elasticity since the variables are in logarithmic units; $(1 - \lambda)\beta$ is the short-run elasticity;

α , β and λ are unknown parameters.

Generally, the parameters are estimated from the following linear relationship:

$$Y_t = (1 - \lambda)\alpha + (1 - \lambda)\beta X_t + \lambda Y_{t-1} .$$

This model may be generalized to:

$$Y_t = (1 - \lambda)\alpha + (1 - \lambda)\beta \sum_{i=0}^N \theta_i X_{t-i} + \lambda \sum_{j=0}^M \theta_j Y_{t-1-j}$$

where

$$\sum_{i=0}^N \theta_i = \sum_{j=0}^M \theta_j = 1 \text{ are unknown weights;}$$

and N and M are specified integers.

If the weights (θ_i 's and θ_j 's) are dependent on the rate of change of the price of electricity and the sum of the weights is unaffected, then the short-run response can change even though the long-run relationships are unchanged. Such a modification can be developed without using nonlinear regression procedures,¹⁰ but this is not the case if λ depends on the rate of change of price. For our purposes, the weights are made linear functions of the rate of change of the price of electricity. The actual form of the model estimated is:

¹⁰The long-run elasticity is generally computed as the ratio of two different linear functions of the estimated coefficients. Our procedure implies that the value of these two functions remains constant.

$$Y_t = (1 - \lambda)\alpha + (1 - \lambda)\beta[(\theta_0 + \gamma R_t) X_t - \gamma R_t X_{t-1}] \\ + \lambda[(\theta_0 + \delta R_t) Y_{t-1} + (\theta_1 - \delta R_t) Y_{t-2}]$$

where

$R_t = \text{Max} [(P_t - P_{t-1})/P_{t-1}, 0]$ is the rate of change of the price, P_t , if this is positive or is zero, and γ and δ are additional unknown parameters.

The immediate response of Y_t to a change of X_t is $(1 - \lambda)\beta(\theta_0 + \gamma R_t)$. If γ is negative, then the short-run effect is smaller when prices are increasing. Similarly if δ is negative, then the structure of the lag distribution is flattened, implying that the response is delayed.

The short-run response of demand to the price of electricity and to income were modified to account for price changes, and the results are summarized in Table 4, and the complete models in Table 11 in the Appendix. A difference between the sign of the base coefficient for income or the price of electricity and the change of this coefficient associated with a price increase indicates that the short-run response is reduced. If the coefficient for the quantity demanded in the previous period is smaller when price increases, then the lag distribution becomes flatter and the overall response is delayed. It follows from Table 4 that the short-run responses to income and price are reduced by price increases in the residential sector, but the opposite is true in the commercial and industrial sectors. In addition, the lag structure does get flatter in the residential and industrial sectors but not in the commercial sector. However, most of the t ratios for the additional variables are small, and in conclusion, there is little reason to doubt that demand will respond to price increases.

Table 4. The effect of increasing the price of electricity on the short-run response of demand.

| Explanatory Factor | Time Period | Estimated Coefficients ³⁾ | | | | | |
|-------------------------|-------------|--------------------------------------|----------------------|-----------------|----------------|----------------|----------------|
| | | Residential ²⁾ | | Commercial | | Industrial | |
| | | Base ¹⁾ | Change ²⁾ | Base | Change | Base | Change |
| 1. Income per capita | T | .135 (4.8) | -.037 (1.0) | .057 (1.1) | .228 (3.1) | .031 (.4) | .052 (1.0) |
| | T-1 | 0.0 | .037 (1.0) | 0.0 | -.228 (3.1) | 0.0 | -.052 (1.0) |
| 2. Price of electricity | T | -.336 (12.7) | .037 (1.8) | -.748 (15.4) | -.006 (0.2) | -.252 (5.3) | -.012 (1.1) |
| | T-1 | 0.0 | -.037 (1.8) | 0.0 | .006 (0.2) | 0.0 | .012 (1.1) |
| 3. Quantity demanded | T-1 | .638 (14.6) | -.014 (.9) | .453 (13.8) | .082 (2.3) | .825 (23.1) | -.006 (.7) |
| | T-2 | .100 (2.6) | .014 (.9) | .040 (1.5) | -.082 (2.3) | -.082 (3.6) | .006 (.7) |

¹⁾ Corresponds to the estimated coefficient evaluated when the price of electricity is decreasing.

²⁾ Corresponds to the estimated change of the base value associated with a 1% increase in the price of electricity.

³⁾ The numbers in parentheses are the absolute values of the T ratios.

Given the experience of the past eighteen months, other modifications of the structure of demand may be more appropriate. For example, decreases in real income or gross national product may cause a relatively sharp response due to industrial shutdowns. Such modifications can be included in the model using similar procedures to those described here.

Emissions of Sulfur Oxides and Health

In addition to forecasting the total quantity of electricity generated, the NERC also forecast the type of fuel used for generation. One of the implications of their forecast is that the use of coal and nuclear fuel for generation is expected to increase substantially more than the use of oil and natural gas. However, if this pattern of generation is actually attained, the levels of sulfur oxides emitted by the utility industry will increase unless strict control measures are enforced such as those specified in the Clean Air Act.

In the first part of this section, predictions are made of the regional distribution of emissions implied by the forecasts of the NERC and CM for 1980. In both cases, a comparison is made between a situation in which the standards of the Clean Air Act are met and one in which no controls are imposed on the industry. If sulfur oxides are removed from emissions, additional generating costs will occur which will inevitably be passed on to customers in the form of higher prices for electricity, and we have assumed that there will be a one-year delay in this process. The cost of controlling emissions is specified to be three mills/kwh in 1970 dollars to give an 85% rate of removal. These values correspond to removal by limescrubbers, and were derived from a study of control technology published by a Federal interagency committee.¹¹

¹¹ Sulfur Oxide Control Technology Assessment Panel, "Final Report on Projected Utilization of Stack Gas Cleaning Systems by Steam-Electric Plants" (April 1973).

The effect of internalizing the cost of removing sulfur on the price of electricity depends on the proportion of electricity generated from oil and coal. Consequently, price increases vary considerably between regions, and the overall effect on demand can be determined using the econometric model discussed in the previous section. Finally, a comparison of the predicted effects of alternative levels of emissions in 1980 on the incidence of major respiratory diseases is presented. Since this part of the analysis was conducted by Finklea et al., only a brief summary of their results is given here. Considerably more information is available in the Report cited in the Introduction (see the report cited in footnote three above).

The Clean Air act specifies a set of minimum standards for ambient air quality which must be met in 1975, and even stricter standards are specified for 1977. The maximum levels of sulfur oxides permitted under this Act, and the average levels of sulfur in the coal and oil used by the utility industry have been estimated by Jameson and Richardson.¹² Given this information, which is summarized in Table 5 for the nine regions identified in Figure 3, it is possible to predict the quantity of sulfur oxides emitted in 1980 for different patterns of generation, both with and without controls on emissions.

Since the level of generation forecasted for 1980 by CM is much less than the level forecast by the NERC, there is potentially a considerable amount of flexibility in the pattern of generation of this smaller quantity. We have assumed that the pattern forecast by the NERC represents the maximum level of generation from each source. In retrospect, the "slippage" which

¹²R.M. Jameson and L.W. Richardson, "Potential Abatement Sulfur Resulting from Environment Regulation," presented at the Fourth Phosphate-Sulfur Symposium, Tarpon Springs, Florida, January 1974.

Table 5. The amount of sulfur contained in coal and oil.

| Region | Actual Percentages | | Percentages Permitted Under the Clean Air Act | | | |
|----------|--------------------|------|---|------|------|------|
| | Coal | Oil | Coal | | Oil | |
| | 1971 | 1971 | 1975 | 1977 | 1975 | 1977 |
| 1. NPCC | 2.10 | 1.40 | 1.40 | 0.72 | 0.45 | 0.42 |
| 2. MAAC | 2.20 | 1.20 | 0.59 | 0.47 | 0.84 | 0.47 |
| 3. SERC | 2.00 | 1.60 | 1.32 | 0.78 | 0.92 | 0.72 |
| 4. ECAR | 2.80 | 2.10 | 1.04 | 0.73 | 2.14 | 0.69 |
| 5. MAIN | 2.90 | 1.20 | 2.15 | 0.80 | 1.15 | 0.70 |
| 6. SWPP | 2.50 | 1.20 | 1.14 | 0.59 | 1.66 | 0.68 |
| 7. ERCOT | 0.60 | 0.23 | 1.80 | 0.50 | 0.88 | 0.70 |
| 8. MARCA | 1.80 | 1.60 | 1.86 | 0.71 | 2.08 | 0.70 |
| 9. WSCC | 0.69 | 0.46 | 0.37 | 0.34 | 0.56 | 0.51 |

Source: Jameson and Richardson (see footnote twelve). The national primary ambient air quality standard is $80 \mu\text{G}/\text{M}^3$ or .03 PPM for sulfur oxides.

has occurred over the past eighteen months in the construction of new plants, which are predominantly nuclear, probably makes the forecast levels of generation from nuclear plants rather high. Since reducing these levels would tend to exacerbate the problem of air quality, our forecasts of emissions in 1980 may, in fact, be too low.

If it is assumed that reducing the quantity of oil imported is a primary objective of the utility industry, then generation from hydro, nuclear or coal plants is to be preferred to the use of oil or natural gas. If, in contrast, the policy is to minimize the quantity of emissions of sulfur oxides, then coal and oil are the least preferred fuels. Two patterns of generation, corresponding to these two policy alternatives, have been derived for the level of generation forecast for 1980 by CM. The resulting levels of emissions are summarized in Table 6 together with those corresponding to the forecast made by the NERC and the actual levels in 1970.

The results in Table 6 imply that if emissions are uncontrolled, the pattern of generation proposed by the NERC for 1980 will lead to substantial increases in the levels of sulfur oxides in all regions. This is especially serious in the eastern part of the country (Regions 1-5) because here the initial levels are already high and the density of population is the greatest. If, however, the standards implied in the Clean Air Act are enforced, emissions can be reduced to 50% of the level in 1970.

The low level of generation forecast by CM implies, as one would expect, lower emissions than those of the NERC. Even if no controls are enforced, emissions can actually be reduced from the level in 1970 by using cleaner sources of generation to the maximum extent possible. However, this is most effective in the western states where natural gas supplies are more plentiful. In the East, especially in Region 4, this strategy is less viable. Consequently, we conclude that removal

of sulfur from emissions is the only reliable way of reducing levels of sulfur oxides in the eastern states. The higher prices charged for electricity, which are required if controls are enforced, will reduce the quantity of electricity demanded to some extent. This is reflected by the lower forecasts of generation when sulfur is removed from emissions.

To determine the effects of increased emissions of sulfur oxides on health, three steps in the analysis conducted by Finklea et al. can be identified. These are:

- a) to determine the size and composition of the population exposed to emissions in each region;
- b) to determine the relationship between increased emissions of sulfur oxides and the probability distribution of different concentrations of sulfates; and
- c) to determine the threshold concentration of sulfates and the response to higher concentrations for major respiratory diseases.

The analysis was limited to the eastern part of the country (Regions 1-5). Estimates of premature mortality and of excess incidents of five respiratory ailments associated with increased emissions of sulfur oxides from the utility industry are summarized in Table 7 for the six alternative distributions of emissions in 1980 presented in Table 6.

For our purposes, it is sufficient to note that if increased emissions are permitted, serious effects on health will result even though the magnitudes in Table 7 actually represent only a small fraction of the total effects of air pollution. These adverse effects are much smaller if controls on emissions are enforced.

Implications for Government Policy

Two important conclusions may be drawn from our analysis.

Table 6. Forecasts of the levels of sulfur oxides emitted (million tons).

| Region | | Actual Levels in 1970 | Forecasted Levels in 1980 | | | | | |
|--------|-------|--------------------------|---------------------------|------------------|--------------------|-----|---------------------|-----|
| | | | NERC ¹⁾ | | CM I ²⁾ | | CM II ²⁾ | |
| | | | NSR ³⁾ | SR ³⁾ | NSR | SR | NSR | SR |
| 1. | NPCC | 3.1 | 3.8 | 1.0 | 2.1 | .3 | 1.3 | .2 |
| 2. | MACC | | | | | | | |
| 3. | SERC | 3.6 | 6.5 | 2.2 | 3.8 | .5 | 2.3 | .3 |
| 4. | ECAR | 6.2 | 10.0 | 2.3 | 7.0 | .9 | 6.7 | .9 |
| 5. | MAIN | 2.7 | 3.7 | 1.0 | 2.6 | .3 | 1.9 | .2 |
| 6. | SWPP | 0.4 | 2.5 | 0.4 | 2.1 | 2.1 | .1 | .1 |
| 7. | ERCOT | | | | | | | |
| 8. | MARCA | 0.6 | 1.3 | 0.4 | .9 | .9 | .6 | .6 |
| 9. | WSCC | 0.2 | 1.1 | 0.5 | 1.0 | 1.0 | .3 | .3 |
| Total | | 16.8 | 28.9 | 7.8 | 19.5 | 6.0 | 13.2 | 2.6 |

| Source of Generation (Billion kwh) | | | | | | | |
|------------------------------------|-------|-------|-------|-------|-------|-------|--|
| Oil | 183 | 540 | 101 | 81 | 422 | 400 | |
| Gas | 369 | 475 | 208 | 207 | 471 | 471 | |
| Coal | 709 | 1,314 | 1,044 | 958 | 461 | 381 | |
| Nuclear | 22 | 533 | 533 | 533 | 533 | 533 | |
| Hydro | 247 | 325 | 325 | 325 | 325 | 325 | |
| Total | 1,530 | 3,187 | 2,211 | 2,104 | 2,212 | 2,110 | |

1) Forecast published by the NERC in 1973

2) CM I - Policy to reduce imports.
CM II - Policy to reduce emissions.

3) NSR - No sulfur removed from emissions.
SR - Sulfur removed from emissions.

Table 7. Estimates of the adverse effects of emissions on premature mortality and respiratory diseases in 1980. 1)

| Effect | Units | Source of Forecast for the level of Generation ²⁾ | | | | | |
|--|-----------|---|------|-------|------|-------|------|
| | | NERC | | CM I | | CM II | |
| | | NSR | SR | NSR | SR | NSR | SR |
| 1. Premature mortality | Millions | 4.74 | .22 | 2.31 | 1.33 | .57 | .07 |
| 2. Excess attacks of asthma | Millions | 11.54 | 3.29 | 7.92 | 3.70 | 4.55 | 1.73 |
| 3. Excess days of aggravated heart and lung diseases | Millions | 32.11 | 6.62 | 20.31 | 9.09 | 10.07 | 3.06 |
| 4. Excess cases of acute respiratory disease in children | Thousands | 669 | 0 | 308 | 169 | 42 | 0 |
| 5. Excess cases of chronic respiratory disease (non-smokers) | Thousands | 860 | 33 | 434 | 185 | 136 | 0 |
| 6. Excess cases of chronic respiratory disease (smokers) | Thousands | 535 | 0 | 187 | 135 | 12 | 0 |

1) Based on the work of Finklea et al., National Environmental Research Center, North Carolina (see Federal Energy Administration, footnote two above).

2) The levels and distribution of emissions of sulfur oxides are presented in Table 6.

First, the expansion of generating capacity planned by the utility industry is too large. Our forecast of 2.2 trillion kwh of electricity generated in 1980 contrasts dramatically with the forecasts of over three trillion kwh made by the NERC. Secondly, the extensive use of coal by utilities may have serious adverse effects on the general health of the population in eastern states. Consequently, sulfur oxides should be removed from emissions by enforcing the standards specified in the Clean Air Act.

The main problem facing the utility industry is perceived by many to be the inability of companies to secure sufficient capital for their expansion programs. As a result, pressure has been applied on the government in two directions. First, various forms of direct and indirect subsidization, such as issuing tax-free bonds by the industry, have been proposed to help capital formation. Second, efforts have been made to postpone implementation of the Clean Air Act to avoid expected shortages of power and to save on the additional expense of installing equipment for removing sulfur.

If utility companies are successful in their efforts to expand generating capacity by obtaining subsidies and by ignoring environmental costs, our results imply that companies will overexpand their generating capacity. With extra capacity available and capital expenses already committed, company executives will look for ways for increasing sales. Inevitably, it will be profitable to encourage large-scale users of electricity by charging them attractive low prices. To this extent, it is possible to obtain relatively high growth rates in the industry if a large enough number of extravagant uses for electricity can be found. If such attempts are successful, all of the rules for the efficient allocation of scarce resources are violated. We believe that a more appropriate solution to the problem exists.

Attempts to expand the generation of electricity will continue to face increasing costs due to the dwindling supplies of easily accessible fossil and nuclear fuels. If these costs, including the costs of maintaining environmental quality, are reflected in the prices charged for electricity, the growth of demand will be reduced and so will the need for large quantities of capital for expansion. In the long-run, the best policy is to internalize environmental costs rather than to try to maintain an unrealistically high growth rate of sales of electricity. In this way, the level of health and the quality of the environment will not deteriorate any further and may, in fact, improve. Unnecessary medical expenses will not be imposed on the public, and there will be less need to institute extraordinary measures for supporting the utility industry.

One of the arguments against reversing the past trend of generating more electricity at lower prices is that poor families will be prevented from increasing their material well-being. However, since the current practice in the utility industry is to lower the price charged as the quantity demanded by a customer increases, the potential exists for increasing the overall average price for all customers but not for small-scale users. This can be achieved by flattening existing rate schedules.

There has been a long-standing argument in the econometric literature about whether the average or the marginal price is a more appropriate explanatory factor in models of the demand for electricity. The price of electricity in Tables 1 and 2 is, in fact, an average price. However, we have recently included both prices in our models in an attempt to measure the shape of the rate schedule as well as the general level. Equality between the marginal and average price implies that the rate schedule is flat, but in practice, the typical marginal price is less than the typical average price because rate schedules

decline. The marginal prices paid by some individuals may, of course, be greater than the average price in the sector. To reflect this shape, the ratio of the two typical prices appears as an explanatory factor in the models summarized in Tables 9 and 10 in the Appendix. Although Table 9 is the basis for deriving the forecasts discussed in the previous two sections, the definition of the price ratio used to estimate the models in Table 10 is preferred, and these models underlie the following analysis. This change in the definition of the price ratio is the only difference between the models, and the resulting changes in the estimated long-run elasticities are, in fact, minor.

The estimated coefficient for the ratio of the marginal to the average price is positive in the residential sector and negative in the other two sectors. This implies that if rate schedules were flattened for residential customers, the sales of electricity would increase in this sector, assuming that all other factors including the average price were unchanged. An explanation for this is that flattening the rate schedule decreases the average price paid by a large number of small-scale users, and increases the average price for a relatively few large-scale users such as those with all-electric homes. The sum of these two opposing effects is positive, implying an increase in sales. In the commercial and industrial sectors, the net effect is negative. The predicted effects on sales are, however, relatively small in all sectors. This is illustrated by the results summarized in Table 8. The overall effect of flattening rate schedules within each sector is to increase sales by less than 1%.

Similar results are obtained if prices are flattened between sectors. At the present time, residential customers pay substantially higher prices than industrial customers. For example, in New York State the average residential price was 2.5 times the average industrial price in 1972. The effect

of charging the same price in all three sectors is also summarized in Table 8. Increases of residential and commercial sales are not large enough to offset the reduction of industrial sales, and the net effect is a 1.5% drop in sales. This drop can be reduced to less than 1% if rates are also flattened within each sector.

We recognize that the predictions presented in Table 8 are tentative. First, the quality of data on rate schedules at this level of aggregation is poor. In addition, any piecemeal adoption of a policy to reduce price differences between customers could encourage some industrial customers to move to other regions. This would effect sales dramatically within given service areas. We do wish, however, to demonstrate that a relatively wide range of choices exists with regard to the prices charged to different customers, and we do question the practice of promoting sales of electricity by charging low prices to selected groups.

Many may doubt the advisability of increasing the price of electricity charged to industrial customers on the basis that hindering industrial expansion in this way would lead to more unemployment. Such an argument ignores the potential for substituting labor for energy. For example, the recent work of Hudson and Jorgenson¹³ predicts that higher energy prices in manufacturing will increase the need for labor and reduce the need for energy, other raw materials and capital. In conclusion, we believe that viable long-range solutions to the "energy crisis" can not be instituted unless the potential is recognized for alleviating the problem of inadequate supplies of energy through the use of policies affecting demand.

¹³E.A. Hudson and D.W. Jorgenson, "US Energy Policy and Economic Growth, 1975-2000," The Bell Journal of Economics and Management Science, 5 (Autumn 1974).

Table 8. Predicted effects of flattening rate schedules.

| Sector | | Predicted Sales in 1972 (Billion kwh) | |
|--------------------------------------|-------------------------------|--|--|
| | | Actual Average Price In Each Sector | The Same Average Price in Each Sector |
| Residential (509.4) ¹⁾ | 1. Actual rate schedule | 508.7 | 542.4 |
| | 2. Flattened rate schedule | 525.7 | 560.6 |
| Commercial (360.1) | 1. Actual rate schedule | 353.6 | 383.9 |
| | 2. Flattened rate schedule | 347.7 | 377.5 |
| Industrial (637.2) | 1. Actual rate schedule | 627.8 | 542.2 |
| | 2. Flattened rate schedule | 627.6 | 542.0 |
| Total (1,506.7) | 1. Actual rate schedule | 1,490.1 | 1,468.5 |
| | 2. Flattened rate schedule | 1,501.0 | 1,480.1 |

¹⁾The numbers in parentheses are the actual sales for 1972 in billion kwh.

APPENDIX

The objective of the statistical analysis is to estimate the magnitudes of relationships between the quantity of electricity demanded and major explanatory factors for three classes of customer. These explanatory factors include the number of customers, real income per capita, the prices of electricity, of gas, of oil, of coal, of electric appliances or machinery, of labor, and of raw materials (wholesale price index), and the gross national product. In addition, the degree of urbanization, a measure of the slope of rate schedules for electricity, and the proportion of customers in the residential and industrial sectors¹⁴ are also used as explanatory factors. Data have been collected for forty-seven contiguous states¹⁵ in the US for the years 1963 to 1972. The functional form of the demand relationship is linear in logarithms, and a lagged dependent variable is used as a regressor to account for the dynamic characteristic of demand. This type of model based on pooled cross-section (states) and time-series (years) data has been used by Balestra and Nerlove¹⁶ to estimate the demand relationship for natural gas. Such a

¹⁴These two proportions account for changes in the classification schemes used by utility companies to allocate customers to the different sectors. Omission of these variables leads to overestimation of the absolute magnitudes of direct price elasticities in the commercial and industrial sectors.

¹⁵North and South Carolina are combined, and Washington, D.C. is included with Maryland.

¹⁶P. Balestra and M. Nerlove, "Pooling Cross-section and Time-series data in the Estimation of a Dynamic Model: The Demand for Natural Gas," Econometrica, 34 (1966), 585-612.

model may be written as follows:

$$Y_{it} = (1 - \lambda)\alpha + \sum_{n=1}^N (1 - \lambda)\beta_n X_{nit} + \lambda Y_{it-1} \\ + \mu_i + \epsilon_{it}$$

where

$i = 1, 2, \dots, 47$ represent states;

$t = 1, 2, \dots, 10$ represent the years 1963 to 1972;

Y_{it} = the logarithm of the quantity of electricity demanded in state i during year t ;

X_{nit} , $n = 1, 2, \dots, N$ are the corresponding explanatory variables, such as the logarithm of real income per capita;

$\alpha, \lambda, \beta_1, \beta_2, \dots, \beta_N$ = unknown parameters¹⁷;

μ_i = an unobserved random effect corresponding to state i ;

ϵ_{it} = an unobserved residual.¹⁸

¹⁷The short-run elasticity is the $(1 - \lambda)\beta_n$, and β_n is the long-run elasticity (see Table 1).

¹⁸The exact statistical specifications are:

$$E[\mu_i] = E[\epsilon_{it}] = E[\mu_i \epsilon_{it}] = 0 \text{ for all } i \text{ and } t;$$

$$E[\mu_i \mu_j] = \sigma_\mu^2 \text{ if } i = j; \\ = 0 \text{ otherwise;}$$

$$E[\epsilon_{it} \epsilon_{js}] = \sigma_\epsilon^2 \text{ if } i = j \text{ and } t = s; \\ = 0 \text{ otherwise.}$$

Given the data and the model specification, the next objective is to estimate the unknown slope parameters. The ordinary least squares estimator is inconsistent due to the presence of a lagged dependent variable (Y_{it-1}) unless there are no systematic differences between states (i.e. unless $\mu_1 = \mu_2 = \dots = \mu_{47}$). The generalized least squares estimator proposed by Balestra and Nerlove is consistent, and this is the method used to derive the estimates summarized in Tables 9, 10 and 11. The two unknown variances are estimated using a procedure proposed by Amemiya.¹⁹ Ordinary least squares estimates of the unknown slope parameters are obtained assuming that the state effects ($\mu_1, \mu_2, \dots, \mu_{47}$) are additional unknown parameters. The resulting estimated residuals are used to derive standard analysis of variance estimates of the two unknown variances. This is straightforward since the data are balanced.

The sources of the data used for estimation are summarized in Table 12. There is one variable, however, which requires some further explanation, namely, the price ratio for electricity. Typical average prices may be determined directly from the ratio of revenues to sales, but typical marginal prices, which are generally lower than average prices due to the shape of rate schedules, are not as easy to determine. In our analysis, we have estimated the ratio of these prices directly by assuming that the relationship between expenditures and purchases per customer is linear in

¹⁹T. Amemiya, "The Estimation of the Variances in a Variance-Components Model," International Economic Review, 12 (1971), 1-13.

Table 9. Estimated demand models for electricity.

| Explanatory Variable ¹⁾ | Class of Customer | | | | | |
|---|-------------------|----------------------|------------|----------------------|------------|----------------------|
| | Residential | | Commercial | | Industrial | |
| 1. Quantity demanded in the previous period | .734 | (42.8) ²⁾ | .554 | (22.3) ²⁾ | .727 | (33.5) ²⁾ |
| 2. Number of customers | .270 | (13.3) | .412 | (9.4) | .178 | (7.0) |
| 3. Real income per capita | .163 | (6.4) | .101 | (1.9) | .088 | (1.1) |
| 4. Price of electricity | -.311 | (14.9) | -.544 | (11.3) | -.272 | (6.8) |
| 5. Price of gas | .008 | (.8) | 0 | | 0 | |
| 6. Price of fuel oil | .163 | (2.7) | .288 | (2.1) | .025 | (2.0) |
| 7. Price of coal | | | | | .030 | (1.7) |
| 8. Price of electric appliances or machinery | 0 | | 0 | | -.043 | (.2) |
| 9. Unit labor cost | -- | | .452 | (4.1) | .283 | (1.8) |
| 10. Wholesale price index | -- | | 1.151 | (3.5) | 1.399 | (3.9) |
| 11. Gross national product | -- | | -- | | .137 | (1.7) |
| 12. Degree of Urbanization | -.003 | (4.0) | -.004 | (2.2) | .003 | (1.8) |
| 13. Price ratio for electricity ³⁾ | .032 | (1.9) | .039 | (1.1) | -.008 | (.4) |
| 14. Proportion of customers in the residential sector | .080 | (.3) | 2.238 | (3.1) | -- | |
| 15. Proportion of customers in the industrial sector | -- | | -4.125 | (1.5) | -25.307 | (5.0) |

¹⁾ All variables in dollar units are deflated. Variables numbered 12, 14 and 15 are not transformed to natural logarithms.

²⁾ The absolute values of the ratio between the estimated coefficient and standard error are given in parentheses.

³⁾ This is the ratio between the marginal and average prices.

Table 10. Estimated demand models for electricity.

| Explanatory Variable ¹⁾ | Class of Customer | | | | | |
|--|-------------------|----------------------|------------|----------------------|------------|----------------------|
| | Residential | | Commercial | | Industrial | |
| 1. Quantity demanded in the previous period | .743 | (43.3) ²⁾ | .551 | (22.1) ²⁾ | .727 | (33.6) ²⁾ |
| 2. Number of customers | .259 | (12.4) | .408 | (9.2) | .180 | (7.2) |
| 3. Real income per capita | .136 | (5.0) | .104 | (1.9) | .084 | (1.1) |
| 4. Price of electricity | -.317 | (15.1) | -.564 | (12.4) | -.271 | (6.8) |
| 5. Price of gas | .008 | (.8) | 0 | | 0 | |
| 6. Price of fuel oil | .169 | (2.1) | .294 | (2.1) | .026 | (2.0) |
| 7. Price of coal | | | | | .030 | (1.7) |
| 8. Price of electric appliances or machinery | 0 | | 0 | | -.043 | (.2) |
| 9. Unit labor cost | -- | | .454 | (4.1) | .283 | (1.7) |
| 10. Wholesale price index | -- | | 1.195 | (3.6) | 1.400 | (3.9) |
| 11. Gross national product | -- | | -- | | .138 | (1.7) |
| 12. Degree of urbanization | -.003 | (3.7) | -.004 | (2.2) | .003 | (1.8) |
| 13. Price ratio for electricity ³⁾ (Method C) | .071 | (2.9) | -.094 | (.6) | -.002 | (.0) |
| 14. Proportion of customers in the residential sector | .189 | (.6) | 2.424 | (3.3) | -- | |
| 15. Proportion of customers in the industrial sector | -- | | -3.783 | (1.4) | -25.734 | (5.2) |

¹⁾All variables in dollar units are deflated. Variables numbered 12, 14 and 15 are not transformed to natural logarithms.

²⁾The absolute values of the ratio between the estimated coefficient and standard error are given in parentheses.

³⁾This is the ratio between the marginal and average prices.

Table 11. Estimated demand models for electricity.

| Explanatory Variable | Class of Customer | | | | | |
|--|-------------------|-----------------------|------------|-----------------------|------------|-----------------------|
| | Residential | Commercial | Commercial | Commercial | Industrial | Industrial |
| 1. Quantity Demanded in the previous period | .638 | (14.57) ²⁾ | .453 | (13.77) ²⁾ | .825 | (23.14) ²⁾ |
| 2. Quantity demanded two periods previously | .100 | (2.64) | .040 | (1.51) | -.082 | (3.58) |
| 3. Number of customers | .267 | (11.11) | .441 | (9.57) | .166 | (6.46) |
| 4. Real income per capita | .135 | (4.77) | .057 | (1.11) | .031 | (.390) |
| 5. Price of electricity | -.336 | (12.73) | -.748 | (15.43) | -.252 | (5.26) |
| 6. Price of gas | .009 | (.914) | 0 | | 0 | |
| 7. Price of fuel | .178 | (2.96) | .190 | (1.45) | .022 | (1.75) |
| 8. Price of coal | | | | | .031 | (1.77) |
| 9. Price of electric appliances or machinery | 0 | | 0 | | -.089 | (.413) |
| 10. Unit labor cost | -- | | .183 | (1.64) | .189 | (1.15) |
| 11. Wholesale price index | -- | | .762 | (2.39) | 1.158 | (3.12) |
| 12. Gross national product | -- | | -- | | .188 | (2.25) |
| 13. Degree of urbanization | -.003 | (4.30) | -.005 | (2.51) | .003 | (1.80) |
| 14. Price ratio for electricity ³⁾ (Method C) | .066 | (2.75) | -.166 | (1.14) | -.011 | (.140) |
| 15. Proportion of customers in the residential sector | .204 | (6.57) | 2.872 | (4.08) | -- | |
| 16. Proportion of customers in the industrial sector | -- | | -3.004 | (1.14) | -23.265 | (4.70) |
| 17. Change of income coefficient | -3.727 | (1.02) | 22.784 | (3.15) | 5.158 | (1.00) |
| 18. Change of price coefficient | 3.669 | (1.85) | -.647 | (.155) | -1.247 | (1.14) |
| 19. Change of lag coefficient | -1.405 | (.902) | 8.176 | (2.33) | -.563 | (.660) |

¹⁾All variables in dollar units are deflated. Variables numbered 13, 15 and 16 are not transformed to natural logarithms.

²⁾The absolute values of the ratio between the estimated coefficient and standard error are given in parentheses.

³⁾This is the ratio between the marginal and average prices.

Table 12. Data sources.

| Variable | Class of Customer | | |
|---|-------------------|-----------------|------------|
| | Residential | Commercial | Industrial |
| 1. Quantity of Electricity Demanded | A | A | A |
| 2. Number of Customers | A | A | A |
| 3. Real Income per Capita ^{1),3)} | E | E | E |
| 4. Price of Electricity ^{2),3)} | A | A | A |
| 5. Price of Gas ^{2),3)} | B | B | B |
| 6. Price of Fuel Oil ³⁾ | F ⁴⁾ | F ⁴⁾ | A |
| 7. Price of Coal ³⁾ | F ⁴⁾ | F ⁴⁾ | A |
| 8. Price of Electric Appliances or Machinery ³⁾ | D | D | D |
| 9. Unit Labor Cost ¹⁾ | - | D | D |
| 10. Wholesale Price Index ^{1),3)} | - | D | D |
| 11. Gross National Product ⁵⁾ | - | - | D |
| 12. Degree of Urbanization ¹⁾ | C | C | C |
| 13. Price Ratio for Electricity (Method C) | G | G | G |
| 14. Proportion of Customers | A | A | A |

Note: A = Edison Electric Institute, Statistical Yearbook;

B = American Gas Association, Gas Facts;

C = US Bureau of the Census, Statistical Abstract;

D = President's Council of Economic Advisors, Economic Report of the President;

E = US Department of Commerce, Survey of Current Business;

F = US Bureau of Labor Statistics, Retail Prices and Indexes of Fuels and Utilities;

G = US Federal Power Commission, Typical Electric Bills.

¹⁾ Variable is the same for all three classes of customer.

²⁾ Ratio of revenue to sales.

³⁾ Deflated by the consumer price index given in D.

⁴⁾ Combined index of the retail prices of fuel oil and coal used for both the residential and commercial sectors.

⁵⁾ Deflated by the GNP deflator given in D.

logarithms.²⁰ If this ratio equals one, the rate schedule is flat, and if it is less than one, the rate schedule declines as quantity increases. Two sources of data for the expenditures and purchases per customer were used. First (Method A used for the models in Table 9), different years were grouped together for each state by inspecting the scatter diagram of the logarithm of the observed levels of the two variables. Observations which fell roughly on a straight line were used to estimate the price ratio. With this procedure, the price ratio for each state generally takes on two or three different values over the ten year period. Second (Method C used for the models in Table 10), values of the two variables were taken directly from Typical Electric Bills (see Table 12) for each state and for each year. Hence, the price ratio is estimated separately for each observation. This method is preferred since it is based on more direct information about the rate schedules.

If the exact specification of a representative rate schedule is known, an alternative procedure would be to relate the expenditure per customer, R , to the quantity purchased, Q , in the following way

$$R = a + bQ$$

where

b is the marginal price; and

a is the additional cost above b for the initial blocks.

Both a and b could be used as explanatory factors in the demand models to replace the average price of and the price ratio of

²⁰ If expenditure per customer is R and the quantity purchased is Q , then the approximation is $R = AQ^b$, where A and b are characteristics of the rate schedule. With this specification, b is the ratio of the marginal price (bAQ^{b-1}) to average price (AQ^{b-1}), and b can be estimated using regression procedures if observations of expenditures corresponding to different quantities are available.

electricity. This procedure overcomes the common criticism that the use of average prices makes single equation models inappropriate due to simultaneity.²¹ However, a and b can not be derived directly from the information given in Typical Electric Bills since these parameters are not the same for the different quantities listed. For example, the typical bills for purchases of 250, 500, 750, and 1,000 kwh per month are listed for residential customers, but these four quantities do not necessarily represent the actual blocks for any given rate schedule. A more detailed discussion of this general topic has been given by Taylor.²²

²¹See for example, R. Halvorsen, "Residential Demand for Electric Energy," Review of Economics and Statistics, 57 (1975), 12-18.

²²L.D. Taylor, "The Demand for Electricity: A Survey," Bell Journal of Economics, 6, 1 (1975), 74-110.

Discussion

Sweeney

The Mount study is based upon some very excellent work. His is one of the earlier dynamic models of US energy demand which looks at interfuel substitution. However, the zero natural gas price elasticities suggest that some problems may still exist. A partial explanation to this anomalous result may be that in the USA we have never really had a fully-declared market for natural gas. We had a period of time in the US when pipelines were being built and not everybody was in a gas service region. Furthermore, the fraction of people that were in these regions changed over time. Now we have a situation of shortages and curtailments. Thus with no reliable demand observations (only consumption observations), the resulting "observed demand elasticities" are likely to be most unreliable.

Waverman

Three years ago, Mount and Chapman gave us forecasts of electricity demands. I would have liked to see how their model worked by putting in real 1974 prices because I do not believe their price elasticities. We all know electricity is the most inelastic of all fuels and they show it to be elastic. I just do not believe the elasticity ranges between -1.00 and -1.2. I think the problem is a single equation bias by not having a simultaneous equation system for all the fuels in the sector. It was interesting that you did do the linkage in having sulfur dioxide emission controls feeding back into the price of electricity and diminishing demand. The next thing to do would be a cost-benefit analysis to find some measure of the costs of all those deaths and comparing them to the benefits of having lower prices for electricity.

Ross

I would like to make a comment of some of Mount's work on the health effects of switching intensively to coal. I rather suspect that on a global scale there are some effects, e.g. of the US switching to coal, and these relate to the lack of availability of water for coal mining. In the Western states where much of the coal mining would take place, the water is now being utilized for irrigation and therefore for food production; one has to make a trade-off between food production which feeds people and keeps them alive versus coal production to produce electricity to keep New York City cool in the summer. Perhaps one could make an argument that the sulfur oxide emission in the US plays a smaller role in global health effects than does reduced agricultural production.

Mount

In response to Sweeney's point about low price elasticities for natural gas, I am also rather worried about those, and we are now going to consider the number of gas hookups as another type of explanatory variable.

On Waverman's question, let me say that simultaneity is a serious question. Ashbury and Halverson have tried to deal with this and they get similar price elasticities. Marginal price people like Houthakker and Wilson get similar results to us average price people. In addition, see the work done by Kent Anderson of Rand in which he tried to deal with the indirect demand, in terms of demand for appliances, and then the intensity of appliance use as opposed to our simple procedures where you just estimate the direct relationship for electricity. The problem is that there are no data, and it is a very difficult thing to do.

As for cost-benefits on health, I do not like doing that sort of thing. The choice that faces the US at the moment is whether we are prepared to spend money 1) in the form of higher prices for electricity to cover the cost of removing

sulphur (this comes to about \$0.004 per kwh or, about a 10% increase in price if all the generation comes from coal), or (2) in the form of extra medical expenses. The National Research Council's Committee on Public Engineering Policy (COPEP) has a study where they say that a decrease in mortality of one is worth \$30,000 and that of an asthma attack costs \$10. I do not think that sort of analysis is worthwhile.

The final point I would like to make is on something that Charpentier raised about the response to increasing prices. This is something I did not talk about, but it is discussed in my paper. Many people in the industry say there is no point in making forecasts with our models because they are estimated from periods when prices for electricity were declining. Now that they are going up, everything is very different. We tried to make the response relationship dependent on price increases, but we do not get anything very interesting. I think one of the reasons that the things are not very interesting is that our data only go up to 1972. In terms of the way the models have performed in the recent past, my guess is that econometric analysis does give a way to explain why generation has not increased recently as it did in the past. Most of the econometric procedures that are currently used in the industry have no way of explaining why generation has fallen other than patriotism; and this is hardly convincing.

An Application of the Concepts of Free and Captive
Demand to the Estimating and Simulating
of Energy Demand in Canada

J. Daniel Khazzoom

I. Introduction

In this paper I lay out briefly the basic ideas behind the concepts of free and captive demand, and report estimate results we derived for the manufacturing, mining, and residential-commercial demand for natural gas, oil, coal, and electricity. The estimates were derived by pooling cross section and time series for Canadian Provinces; an extensive review of the data base can be found in Khazzoom [9]. I also report selected simulation results. Some of these were prepared as part of the model development; others were prepared in connection with the Hearings on the James Bay Hydro Project in 1973 and the Hearings by the National Energy Board in 1974 on the future requirements of natural gas in Canada.

The demand¹ for any one of the four major sources of energy (gas, oil, coal, and electricity) may be thought of as made up of two parts--a "captive" and a "free" part. As the names suggest, captive demand is that part of demand which is immobilized by past commitments. It exists because of past investment in appliances that use the energy source in question, and is generally immune to the influence of economic stimuli. Free demand is that part of the demand which is free from past commitments, and which may be reasonably expected to be responsive to changes in the economic conditions.

¹There was no rationing throughout the sampled period. This means ex ante demand = ex post demand, and I therefore use the terms demand and consumption interchangeably in the rest of the manuscript.

For those commodities whose use requires a substantial investment in a stock of appliances, the captive demand makes up the major component of the total. To give you an idea about the magnitudes involved, I prepared Figure 1. Six Canadian provinces are covered: British Columbia, Alberta, Saskatchewan, Manitoba, Ontario, and Quebec. (In estimating the industrial demand for these provinces, we constrained the depreciation rate to zero. See below.) As the diagram shows, the captive component constitutes typically between 85% to 90% of the total industrial demand for gas. Alberta, a major user and producer of natural gas falls in the 90% to 100% range.

The predominance of the captive component in the total results in a reduction in the consumer's agility (or the producer's agility, if the commodity in question is a factor of production), and the overall response of total demand to, say, price variations will be much more restrained than economic theory would lead one to believe. To measure the impact of an economic stimulus on demand, one is well advised to focus on the free demand. Otherwise, the estimates will be swamped by the rigidities in the captive part. In fact, one may not be able to discern any response in the total demand, even though the free component may be extremely sensitive to the stimulus. This point is illustrated in Figure 2 for the two main gas consuming provinces--Alberta and Ontario. Note the stability of the elasticity of total demand as opposed to the variability of the elasticity of the free demand.² Note also how much larger the elasticity of the free demand tends to be compared with the elasticity of total demand.

²In the diagram, the price elasticity of total demand looks completely flat because I plotted the diagram with one decimal point. With two decimals some ripples could have been observed.

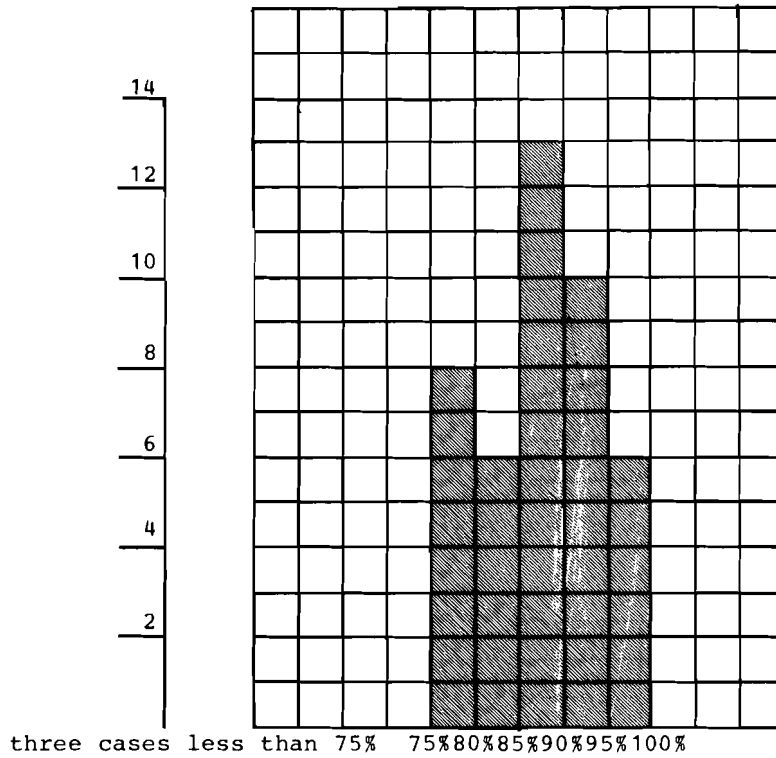

Figure 1. Frequency distribution of the ratio of captive industrial demand to total industrial demand in Canada, 1961-1968.

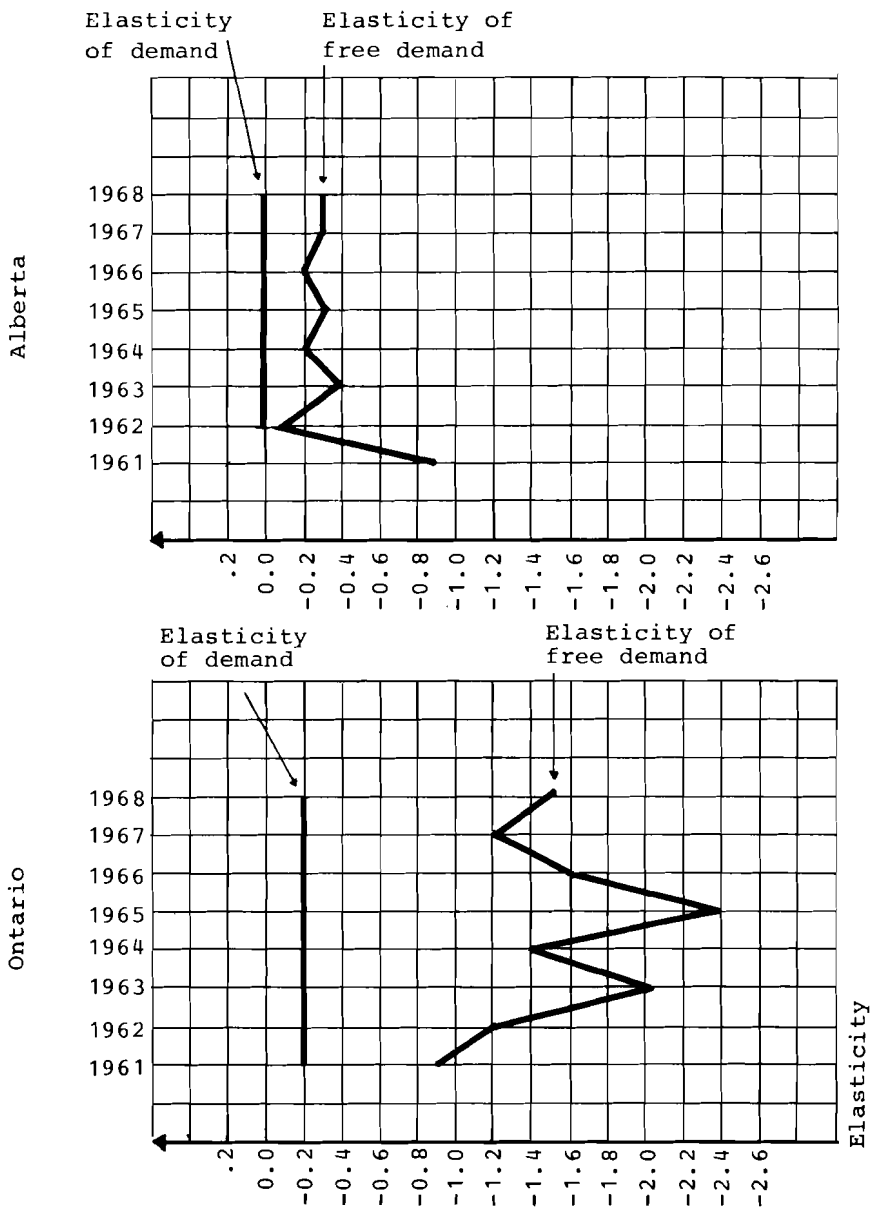

Figure 2. Short run elasticity of industrial demand with respect to gas price, Canada, 1961-1968.

The first statement about the need to isolate the free demand from the rest (at least in the field of energy) appeared a little over a decade ago in a series of testimonies by Sherman Clark [5] before the Federal Power Commission. Clark, who testified on the relationship between gas demand and gas price coined the term "incremental demand." Various versions of this idea were implicit in recent work in investment decision theory (see Dhyrnes and Kurz [4]) and demand analysis (see Fisher and Kaysen [6], Houthakker and Taylor [7], and Balestra and Nerlove [2]).³ The expression for the free demand I use in this study is the same as the expression used in Balestra and Nerlove [2] for "new demand," but it is free from the limitations behind assumptions used in Balestra and Nerlove [2].

Some of the difficulties with the assumptions (and estimate results) of Balestra and Nerlove [2] are discussed in Khazzoom [11].

I use a diagram to identify the free and captive constituents of demand. The step requires a simple transformation from

³Houthakker and Taylor [7], wrote consumption as a function of the existing level of stocks, price and total consumption expenditures. Writing the stock in terms of past scales of the commodity in question, they eliminated the stock variable from the equation, and derived an expression for consumption in terms of lagged consumption, as well as lagged and current values of prices and total consumption expenditures. In a condensed form, we have

$$S_t = \alpha + \beta A_t + \gamma X_t + \delta P_t \quad (1)$$

where S, A, X, and P stand for sales, stock, total consumption expenditures, and price, respectively. Although Houthaker and Taylor wrote their model in the continuous domain, it would be simpler for our illustrative purposes to express the model in the discrete domain. Substituting from (9) below in equation (1) (we reinterpret S in (9) to mean sales of the commodity rather than sales of appliances) and re-arranging terms, we arrive at the equation Houthaker and Taylor estimated

$$S_t = \frac{\alpha r}{1 - \beta} + \frac{\delta}{1 - \beta} P_t + \frac{(1 - r)\delta}{1 - \beta} P_{t-1} + \frac{(1 - r)}{1 - \beta} S_{t-1} \\ + \frac{\gamma}{1 - \beta} X_t + \frac{\gamma(1 - r)}{1 - \beta} X_{t-1} \quad (2)$$

a one- to a two-dimensional space. This is a commonly-used procedure. Often the problem is simplified by transforming it to a higher-dimensional space, solving it in there, and then bringing it back to the lower-dimensional space.

For our purpose, we measure the stock of an appliance in terms of the maximum amount of BTU that may be consumed if this appliance were fully utilized. We can then write the demand for the commodity as the product of the stock of appliances that use that commodity times the stock's utilization rate:

$$D_t = \mu_t A_t \quad (3)$$

where D , μ , and A stand for demand, utilization rate, and stock of appliances, respectively. (The subscript t , denoting time, is attached to μ to indicate that the utilization rate is not constrained to a constant.) The transformation (3) simply means that instead of thinking of demand as a scalar, we will henceforth think of it as a two-dimensional vector identified by a stock of appliances and a utilization rate. In Figure 3 below, the demand at time t , D_t , is seen to represent the area defined by the rectangle in the left hand corner of the diagram. The three components of free demand can be identified in the diagram by noting the change that may take place in the stock of appliances and the utilization rate as we move from t to $t + 1$.

1) At $t + 1$, a certain fraction of the stock of appliances will need to be replaced. If we denote the annual depreciation rate by r , the total depreciated appliances will be rA_t , and the demand in the year $t + 1$ will drop by an amount equal to the area $\mu_t rA_t$ (unless consumers decide to replace their depreciated appliances). This is the replacement demand. It corresponds to the solid area in the diagram.

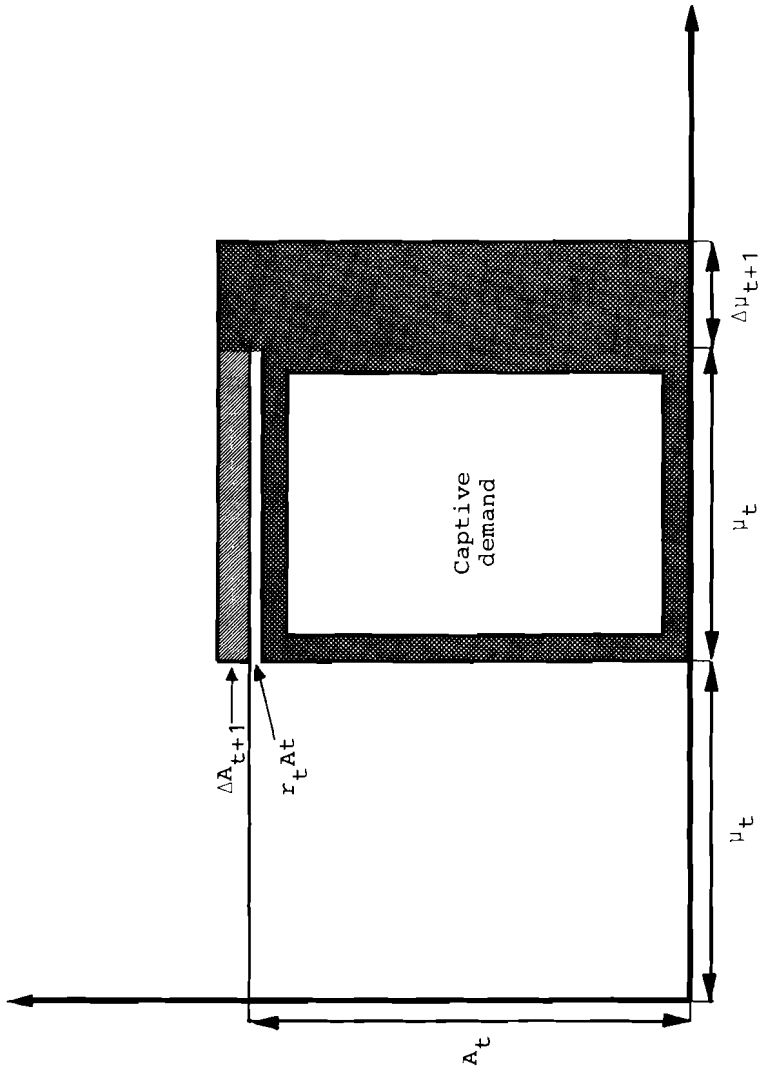

Figure 3. A diagrammatic derivation of the free and captive demand.

2) Some consumers may choose to increase their stock of appliances. With the stock change denoted by ΔA_{t+1} (i.e. $A_{t+1} - A_t$) the increase in demand for the energy source is represented by the area $\mu_t \Delta A_{t+1}$. This is the expansion demand. In the diagram, it corresponds to the shaded area.

The above components, 1) and 2), of free demand involve a decision of a long term nature; both involve a change in the stock itself, and so both have a long term repercussion on the demand for the commodity.

3) A decision of a short-run nature is also open to the consumer. He may increase or decrease the utilization rate of his appliances in response to price variations. In the diagram, we show $\Delta \mu_{t+1} > 0$, but the argument is the same for $\Delta \mu_{t+1} < 0$. The increase in demand due to the increase in utilization rate is equal to the area $A_{t+1} \Delta \mu_{t+1}$. This corresponds to the black rectangle in the diagram.

The sum of the three components, 1), 2), and 3) above, constitutes the free demand at $t + 1$. Denoting the free demand by \mathcal{D} and using the notations defined above, we have

$$\mathcal{D}_{t+1} = \mu_t r A_t + \mu_t \Delta A_{t+1} + A_{t+1} \Delta \mu_{t+1} . \quad (4)$$

Shifting (4) back by one period and making use of (3), we have⁴

$$\mathcal{D}_t = D_t - (1 - r) D_{t-1} . \quad (5)$$

Equation (5) expresses the (unobservable) free demand in terms of current as well as lagged demand. Note that to derive (5) we did not have to constrain μ to a constant.

⁴Please note the difference in notations: \mathcal{D} denotes free demand; the regular D denotes observed demand.

As a fraction of observed demand, the free demand is

$$\frac{D_t}{D_t} = 1 - (1 - r_{t-1}) \frac{D_{t-1}}{D_t} . \quad (6)$$

This is the expression I used in calculating the frequencies shown in Figure 1, except that for the particular case of the industrial demand for gas in Canada, I constrained r to zero. (See below.)

From the transformation (3), one can derive several other useful results. To give one example: Let S and De denote the sales of an appliance (e.g., a coal-using appliance) and the total depreciation of the appliance, respectively, measured as before in terms of BTU equivalent. Then we have:

$$\Delta A_t = S_t - De_t . \quad (7)$$

Assuming that the depreciation rate for the appliance in question can be reasonably approximated by a constant, we have:

$$De_t = rA_{t-1} . \quad (8)$$

Substituting from (8) into (7), rearranging terms and using E^{-1} to denote the (one-period) backward shift operator, we have

$$A_t = \frac{S_t}{1 - (1 - r)E^{-1}} . \quad (9)$$

Substituting from (9) into (3), clearing the denominator and rearranging terms, we have

$$D_t - (1 - r) \frac{\mu_t}{\mu_{t-1}} D_{t-1} = \mu_t S_t . \quad (10)$$

In the special case where we are dealing with an appliance whose utilization rate is known to be constant (10) simplifies to

$$D_t - (1 - r)D_{t-1} = \mu S_t \quad (11)$$

where the lhs of (11) is the same as the rhs of (5). In other words, when we are dealing with an appliance whose depreciation and utilization rates are reasonably constant, the free demand simply reduces to a fraction of the sales of the appliance. This is also as we would expect since the variation in the utilization rate (i.e. the short run effect) is then equal to zero, and we are left only with the long run effect.⁵ Hence, if data on the demand for the commodity that uses that appliance are not available, while data on the sale of the appliance itself are available, then the rhs of (11) provides a useful alternative to the rhs of (5) for expressing the (unobservable) free demand in terms of an observable variable. A good example is the free demand for electricity used in home electric refrigerators.

II. The Industrial Model

The next step is to specify a relationship between the free demand and its determinants. This varies with the markets. Let me begin with the industrial markets.

The industrial demand for an energy source is a demand for a factor of production. As such, we would expect it to

⁵ If we can reasonably assume also that the dollar value of an appliance is a good reflection of its BTU capacity, we may replace the BTU equivalent of the sales by their dollar value. This was implicit in Fisher's estimation of the long run demand for electricity. Fisher used the sales of appliances as the dependent variable (see [6]). When the (fixed) utilization rate is not allowed for, the use of the appliance sales as the dependent variable will overestimate the response parameters in the free demand equation. For $\mu = .8$, the estimated parameters will be 25% larger than they should be.

depend on a production and a price vector. In specifying the relationship we follow the tenets of the neo-classical theory of factor demand. Our only departure is in writing the free demand instead of the total demand as the dependent variable.⁶ Letting \mathcal{D} denote in this section the free industrial demand for gas, we have

$$\mathcal{D}_t = f\left(\frac{P_{G_t}}{P_{S_t}}, MA_t\right) \quad (12)$$

where

P_G denotes the industrial price of gas;

P_S denotes the prices of gas substitutes; and

MA denotes (real) manufacturing production.

(No gas or coal is used in mining production. For electricity and oil, I estimated the mining and manufacturing demand separately.)

In estimating (12) I substituted for \mathcal{D}_t from (5) but constrained the depreciation rate to zero, since the industrial demand for natural gas in Canada is a relatively new phenomenon.⁷ Hence our dependent variable reduces in this

⁶I did implicitly assume though that the production function is separable.

⁷For completeness, I have estimated each version I considered (not reported here) with a variable depreciation rate, as well as with a constant depreciation rate. As expected, the results, though by no means uniform, did not indicate that there was much of a replacement market for gas to start with during the sampled period. Interprovincial gas did not start flowing until 1958 or 1959. Note also that the amount of gas consumed in the early 1960's was very small compared to the later part of the sixties. Hence even if we assume that part of the appliances were to be replaced after six or seven years of use (due to, say, technological obsolescence), this would hardly have any effect on the industrial demand for gas since the whole stock in the early sixties must have been very small.

case to ΔD_t . (For coal, oil, and electricity, however, no such constraint was placed on the replacement demand.) Several problems have to be dealt with prior to estimation. Among these are: a) the operational definitions of P_G and P_S ; b) the problem of joint determination of demand and price. These are dealt with in Khazzoom [9], pp. 24-46. To summarize the discussion of the problem of joint determination: the prices of oil and coal are exogenous variables⁸ for the samples period and, on the assumption that the random terms are serially and contemporaneously uncorrelated, the prices of gas and electricity are predetermined variables in the respective demand equations for these commodities for each province during the 1960's.

Since the form of $f(\cdot)$ in (12) is not known, it is necessary to approximate the function by a Taylor series for estimation. Equation (13) below shows the results for the natural gas model we estimated for the six provinces: British Columbia, Alberta, Saskatchewan, Manitoba, Ontario, and Quebec for 1960-1970. These are the only provinces in which there was industrial consumption of gas during the sixties.

⁸The reader will hardly need to be reminded that the statement in the text is not absolute. The puristic view of what is commonly referred to as exogenous variable will probably lead us nowhere if pursued in practice. This is so because the random terms are not observable. See the lucid discussion of the subject in Christ [3], pp. 159-160. The statement that oil and coal prices are exogenous should be read simply to mean that the process by which oil and coal prices are determined is such that these prices meet closely enough the definition of an exogenous variable. In the case of oil, for example, the statement boils down to the assertion that the demand for oil in individual provinces is not subject to the disturbances that activate world demand as a whole.

$$\begin{aligned}
\Delta G_t &= 20.09 \text{ (B.C.)} + 13.65 \text{ (Rest of Provinces)} \\
t \text{ ratio} & \quad (4.50) \quad \quad \quad (5.22) \\
& - 70.10 \frac{P_{G_t}}{(P_0^P P_C^P P_E^P)_t^{1/3}} + 83.66 \frac{P_{G_t}^2}{(P_0^P P_C^P P_E^P)_t^{2/3}} \\
& \quad (4.89) \quad \quad \quad (4.62) \\
& + 1.21 MA_t + .004 MA_t^2 \\
& \quad (3.66) \quad \quad (2.60) \\
& - 2.11 \frac{P_{G_t}}{(P_0^P P_C^P P_E^P)_t^{1/3}} \cdot MA_t \\
& \quad (3.62)
\end{aligned}$$

$$\bar{R}^2 = .57; \text{ D.F.} = 59; 1960-1970. \quad (13)$$

Table 1 summarizes the estimated results for oil, electricity, and coal for the same period.⁹ We have subjected these models to several predictive and non-predictive tests, and they performed well.

The Multipliers

For all models we estimated, we calculated the impact multipliers and (except for natural gas) the long run multipliers, as well. These are discussed along with tests of the models in Kazzoom [9], pp. 62-88 and [10], pp. 39-56. Since the expressions used in calculating the multipliers are part of a more general expression which were also used in

⁹ P_C, P_E, P_G, P_0 denote simple two-year average price (of t and $t - 1$) for coal, electricity, natural gas, and oil, respectively, in dollars per thousand therm; MA denotes net value added by manufacturers (in $\$10^5$) deflated by the industrial selling price index for manufacturers in Canada; MI denotes gross value of mineral production, excluding cement, (in $\$10^5$) deflated by the wholesale price index of all mineral production in Canada. G_t, O_t, E_t, C_t denote the consumption in trillion BTU of natural gas, oil, electricity, coal, respectively. The superscripts MI and MA identify the manufacturing and mining demand, respectively.

Table 1. Recapitulation of the estimated results for the industrial demand of oil, electricity and coal, Canada 1960-1970.

| | |
|--|---|
| 1. <u>Mining demand for oil, 10 provinces</u> ¹⁾ | |
| $O_t^{M.O.}$ | 1.15 (Atlantic & Que.) + $.18$ (Rest of Prov.) - $3.53 \frac{P_0 t}{(P_C P_E)^{1/2}} + 2.61 \frac{P_0^2 t}{(P_C P_E) t} + .88 M_t$ (2.00) (2.17) (2.27) (3.46) |
| | - $.02 M_t^2 - .56 \frac{P_0 t}{(P_C P_E)^{1/2}} \cdot M_t + .88 O_{t-1}^{M.O.}$ (1.98) (2.29) (18.14) |
| | $\bar{R}^2 = .941$ D.F. = 102 (14) |
| 2. <u>Manufacturing demand for oil, 10 provinces</u> ²⁾ | |
| $O_t^{M.O.}$ | $.69$ (Atlantic & Que.) + 5.01 (Rest of Prov.) - $.93 \frac{P_0 t}{(P_G^2 P_C P_E) t} + .35 M_t$ (.58) (1.76) (2.62) |
| | + $.97 O_{t-1}^{M.O.}$ (Atlantic & Que.) + $.82 O_{t-1}^{M.O.}$ (Rest of Prov.) (22.05) (10.13) |
| | $\bar{R}^2 = .985$ D.F. = 104 (15) |
| 3. <u>Mining demand for electricity, 10 provinces</u> ³⁾ | |
| $E_t^{M.E.}$ | $.40$ (Atlantic) + $.29$ (Rest of Prov.) - $.05 \frac{P_{E_t}}{(P_0 P_C)^{1/2}} + .06 M_t + .98 E_{t-1}^{M.E.}$ (3.00) (2.18) (2.57) (2.77) (45.46) |
| | $\bar{R}^2 = .984$ D.F. = 105 (16) |
| 4. <u>Manufacturing demand for electricity, 10 provinces</u> ⁴⁾ | |
| $E_t^{M.E.}$ | $.72$ (Atlantic) + $.68$ (Que., Ont., & Prairies) + 3.36 (B.C.) - $.21 \frac{P_{E_t}}{(P_0 P_G P_C)^{1/3}}$ (.52) (1.48) (2.08) (2.45) |
| | + $.03 \frac{P_{E_t}^2}{(P_0 P_G P_C)^{2/3}} + .07 M_t - .001 M_t^2 - .10 \frac{E_{t-1}^{M.O.}}{(P_0 P_G P_C) t} + .92 E_{t-1}^{M.O.}$ (.96) (2.84) (1.67) (29.19) |
| | $\bar{R}^2 = .996$ D.F. = 101 (17) |

Table 1. (continued)

5. Industrial (mining & manufacturing) demand for coal, 8 provinces (excl. P.E.I. & N.F.)⁵⁾

$$C_t = 52.33 \text{ (Ontario) } + 7.20 \text{ (Rest of Prov.) } - 22.17 \frac{P_{Ct}}{(P_{0PGE})^{1/3}} + 13.61 \frac{P_{Ct}^2}{(P_{0PGE})^{2/3}} + .83 \text{ Mod}_t \quad (3.37) \quad (1.45) \quad (1.26) \quad (1.01) \quad (2.12)$$

$$- .002 \text{ Mod}_t^2 - .59 \frac{P_{Ct}}{(P_{0PGE})^{1/3}} \text{ Mod}_t + .72 C_{t-1} \quad \bar{R}^2 = .995 \text{ D.F.} = 80 \quad (2.29) \quad (1.19) \quad (9.55) \quad (18)$$

-
- 1) For P.E.I. from 1968 on the price of substitutes includes the price of electricity only.
 - 2) For the Atlantic Provinces (with the exception of P.E.I. from 1968 on), the price of substitutes includes the price of coal and electricity. For P.E.I. from 1968 on, the price of substitutes includes the price of electricity only.
 - 3) For P.E.I. the price of substitutes includes the price of oil from 1968 on.
 - 4) For the Atlantic Provinces (except for P.E.I. from 1968 on), the price of substitutes includes only the price of oil and coal. For P.E.I., from 1968 on, the price of substitutes includes only the price of oil.
 - 5) For N.S. and N.B., the price of substitutes includes the price of oil and electricity only.

determining the simulation horizons, it is probably worthwhile to take time at this stage to derive the more general expression. Without loss of generality, I will focus on equation (17) in Table 1 which shows the manufacturing demand for electricity.

For clarity's sake, let us write P_{E_t} in terms of what it stands for explicitly--namely, $P_{E_t} = \frac{P_{e_t} + P_{e_{t-1}}}{2}$, where P_{e_t} denotes electricity price in the year t . Similarly, to focus on the main points, let us also write $(P_0 P_G P_C)_t$ in the compact form P_{S_t} (for the price of substitutes).

We can now initiate the model at $t = 0$. Shifting (17) successively forward by one period at a time, and substituting in the resulting equations, we can rewrite the manufacturing demand for electricity as:

$$\begin{aligned}
 E_T^{MA} = & \sum_{t=1}^T \kappa^{T-t} \left\{ \alpha - \beta_1 \left(\frac{P_{e_t} + P_{e_{t-1}}}{2P_{S_t}^{1/3}} \right) \right. \\
 & + \beta_2 \left(\frac{P_{e_t} + P_{e_{t-1}}}{2P_{S_t}^{1/3}} \right)^2 + \gamma_1 MA_t - \gamma_2 (MA)_t^2 \\
 & \left. - \delta \left(\frac{P_{e_t} + P_{e_{t-1}}}{2P_{S_t}^{1/3}} \right) \cdot MA \right\} + \kappa^T E_0^{MA} . \quad (19)
 \end{aligned}$$

Recall, we estimated three intercepts for E_t^{MA} ; one for British Columbia; one for Quebec, Ontario and the Prairie Provinces; and one for the Atlantic Provinces, so that there are really three different terms in α , depending on the province. Otherwise, we estimated $\beta_1 = .21$; $\beta_2 = .03$; $\gamma_1 = .70$; $\gamma_2 = .001$; $\delta = .10$ and $\kappa = .92$.

The general expression for the response of electricity demand to electricity price over consecutive periods can be derived by differentiating (19) with respect to P_{e_t} , $t = 1, 2, \dots, T$. We have:

$$\frac{\partial E_T^{U.S.}}{\partial P_{e_t}} = \begin{cases} \frac{1}{2P_{S_t}^{1/3}} \left\{ -\beta_1 + \beta_2 \left(\frac{P_{e_t} + P_{e_{t-1}}}{P_{S_t}^{1/3}} \right) - \delta MA_t \right\} & t = 1 \\ \sum_{i=0}^{T-t} \frac{\kappa^{T-t-i}}{2P_{S_{t+i}}^{1/3}} \left\{ -\beta_1 + \beta_2 \left(\frac{P_{e_{t+i}} + P_{e_{t-1+i}}}{P_{S_{t+i}}^{1/3}} \right) - \delta MA_{t+i} \right\} & 1 \leq t < T \end{cases} \quad (20)$$

Similarly the general expression for the response of electricity demand to manufacturing production over consecutive periods can be derived by differentiating (19) with respect to MA_t , $t = 1, 2, 3, \dots, T$. We have:

$$\frac{\partial E_T^{U.S.}}{\partial MA_t} = \kappa^{T-t} \left\{ \gamma_1 - 2\gamma_2 MA_t - \delta \left(\frac{P_{e_t} + P_{e_{t-1}}}{2P_{S_t}^{1/3}} \right) \right\} \quad 1 \leq t \leq T \quad (21)$$

Equations (20) and (21) will be useful in their present format as a control mechanism for determining the maximum horizon over which simulation can be carried out meaningfully. We will return to this subject in a minute.

For $t = T = 1$, the first row in (20) shows what is customarily¹⁰ referred to as the impact multiplier (or the

¹⁰The first row in (20) gives the immediate effect for any $t = T$. I have added in the text the stipulation that $t = T = 1$ since it is common practice to define the impact multiplier with reference to the first period. But this, of course, need not be so, and the impact multiplier is applicable for any $t = T$ as (20) shows.

immediate effect) of the price of electricity on the manufacturing demand for electricity. The second row shows the interim (or intermediate run) multipliers of the price of electricity on the manufacturing demand for electricity. The same terminology applies to the various multipliers of the manufacturing demand for electricity shown in (21).

Equation (20) shows the expression for the price multipliers in its most general form. The time path of the response of electricity demand to a one-year impulse in the price of electricity (that is, an increase in the price of electricity which occurs in a single year, but which is not sustained thereafter) can be derived by simply fixing t in (20), and letting T vary over the range of interest.

When t is fixed at $t = 1$, (20) yields:

$$\frac{\partial E_T^{MA}}{\partial P_{e_1}} = \begin{cases} \frac{1}{2P_{S_1}^{1/3}} \left\{ -\beta_1 + \beta_2 \left(\frac{P_{e_1} + P_{e_0}}{P_{S_1}^{1/3}} \right) - \delta MA_1 \right\} & T = 1 \\ \sum_{i=1}^T \frac{\kappa^{T-i-1}}{2P_{S_{i+1}}^{1/3}} \left\{ -\beta_1 + \beta_2 \left(\frac{P_{e_{i+1}} + P_{e_i}}{P_{S_{i+1}}^{1/3}} \right) - \delta MA_{i+1} \right\} & T > 1 \end{cases} \quad (22)$$

The cumulative response in period τ after the impulse

is $\sum_{T=1}^{\tau} \frac{\partial E_T^{MA}}{\partial P_{e_1}}$, and its limiting value $\tau \rightarrow \infty$ is referred to as

the total response or long-run multiplier.

Since the interim responses are monotonically decreasing functions of time ($\kappa < 1$) the electricity demand will gradually gravitate back to its initial level, E_1^{MA} , as the cumulative response approaches its limiting value. Assuming all variables in (22) are held fixed at their level in period 1, and letting

the constant c denote $\frac{1}{2P_{S_1}^{1/3}} \left[-\beta_1 + \beta_2 \left(\frac{P_{e_1} + P_{e_0}}{P_{S_1}^{1/3}} \right) - \delta MA_1 \right]$,
 the total response will approach $\frac{2c}{1-\kappa}$ as the demand for
 electricity returns to its initial level E_1^{MA} .

When the impulse is sustained, demand of course will not return to its original level but drop steadily. At time τ , the amount by which demand has dropped from its level in period 1 is given by:

$$dE_{\tau}^{MA} = \frac{\partial E_{\tau}^{MA}}{\partial p_{e_1}} dp_{e_1} + \frac{\partial E_{\tau}^{MA}}{\partial p_{e_2}} dp_{e_2} + \dots + \frac{\partial E_{\tau}^{MA}}{\partial p_{e_{\tau}}} dp_{e_{\tau}} \quad (23)$$

But since $\frac{\partial E_{\tau}^{MA}}{\partial p_{e_2}} = \frac{\partial E_{\tau-1}^{MA}}{\partial p_{e_1}}$; $\frac{\partial E_{\tau}^{MA}}{\partial p_{e_3}} = \frac{\partial E_{\tau-2}^{MA}}{\partial p_{e_1}}$; etc., equation (23)

may be written alternatively as:

$$\begin{aligned} dE_{\tau}^{MA} &= \left(\frac{\partial E_{\tau}^{MA}}{\partial p_{e_1}} + \frac{\partial E_{\tau-1}^{MA}}{\partial p_{e_1}} + \dots + \frac{\partial E_1^{MA}}{\partial p_{e_1}} \right) dp_1 \\ &= \sum_{T=1}^{\tau} \frac{\partial E_T^{MA}}{\partial p_{e_1}} dp_{e_1} \end{aligned} \quad (24)$$

where I substituted dp_1 for dp_t , $t = 2, \dots, T$ (the sustained increase in price is the same throughout).

Equation (24) says that when the increase in the price of electricity is sustained, the demand for electricity at $T = \tau$ will be lower than it was at $T = 1$ by an amount equal to the cumulative response we calculated from (22) for $T = \tau$,¹¹ and that in the limit demand will reach a level which is

¹¹ In the case of the one-year impulse, of course, the demand at time $T = \tau$ will be lower than demand at time $T = 1$ only by an amount equal to the interim response (not the cumulative response) at $T = \tau$.

$\frac{2c}{1-\kappa}$ lower than its initial level $E_1^{M,d}$.¹² This is also the same result we get if we were to solve (17) for the equilibrium value $\bar{E}^{M,d}$ when the explanatory variables are held fixed at some equilibrium level (which could be any level, including their value at $T = 1$) and differentiate $\bar{E}^{M,d}$ with respect to the equilibrium price of electricity.

Similar remarks apply when the instrument is the production rather than the price variable. Our point of departure would then be equation (21). The only difference is that the long run multiplier here is $\frac{1}{1-\kappa}$ (rather than $\frac{2}{1-\kappa}$) times the impact multiplier (on the assumption that all predetermined variables are held fixed). Everything that has been said so far is applicable to the linear models as well.

A knowledge of the time path of the response of demand to changes in the price variable or to changes in the production variable is important for policy purposes. This should be clear from the above discussion since policy measures taken today may have substantial consequences in the future due to the

¹²When estimates of demand in a future period are needed manual computations are necessary when no access to a computer is available. It is easy to get the estimate of demand for any time in the future without having to calculate the demand in every intervening year by simply solving the difference equation (17). For example when the increase in the price of electricity at $t = 1$ is sustained, we can write $E_t^{M,d} - \kappa E_{t-1}^{M,d} = m$, where m denotes the (constant) value on the right hand side of (17) for period 2. The general solution is then given by $E_t^{M,d} = B\kappa^{t-2} + \frac{m}{1-\kappa}$ where $B = \left(E_2 - \frac{m}{1-\kappa}\right)$. Electricity demand can then be calculated for any time t in the future. In addition, when the postulated increase in price is assumed to increase by constant amounts, the difference equation (17) can be solved in a similar fashion, except that the particular solution will have trend terms in it. Similarly, when the postulated increase in price is assumed to increase by a constant percentage, the particular solution can be found by the method of undetermined coefficients, or by making use of known results for polynomial functions of shift operators. See Allen [1], pp. 176-208 and Kaplan [8], pp. 151-170.

existence of delayed (interim) responses. Proper decision making requires a knowledge of the time profile of the expected effect of alternative policy measures. To keep this work within scope, I will not pursue this subject in detail here.¹³

It is important to keep in mind though that an analysis of the impact multipliers by itself is not adequate since, as I indicated above, it does not take into account the subsequent responses. Yet, it is quite conceivable that while the impact of, say, manufacturing production on electricity demand may be smaller than the impact of manufacturing production on coal demand, the cumulative effect may be such that the reverse is true in the long run. Proper decision making should take this fact into account. To the extent that the picture conveyed by the long run multipliers reverses the initial one conveyed by the impact multipliers, it is evident that somewhere along the line the interim multipliers have built up in one case faster than in the other to a point where the initial picture was reversed. It should not be difficult then to determine from an analysis of the interim multipliers the number of years it took this reversal to materialize.

The Horizon of the Simulation

In dealing with a non-linear model, it is important not to overlook the fact that the effect on the dependent variable of a change in an instrument is determined, among other things, by the level of that instrument. In simulation, there is always the danger that the postulated change in an instrument may, after a finite number of years, carry the simulation to an inadmissible region of the estimated surface, where the simulation results cease to make economic sense. In practice it is not always easy to detect when the region has been reached, by simply looking at the dependent variable. This is also made

¹³ I have worked out the analysis elsewhere. The interested reader may want to consult Federal Power Commission [5], Section 5, pp. 67-74; and Tables III.38 and III.39 in Khazzoom [10].

more difficult when there are several provinces to be watched, and when changes in several instruments are assumed to take place simultaneously. For this reason, it is important to have some control mechanism which enables us to determine in advance the horizon (or the number of years ahead) for which a simulation experiment can be carried out, before the inadmissible region is reached. Equations (20) and (21) provide such a mechanism. To be specific let us focus on equation (20).

As electricity price is allowed to increase (holding MA_t and P_{S_t} fixed), a point may be reached when (20) becomes positive. This is also implied in the quadratic relationship for $E_t^{M.A.}$. With P_{e_t} rising, the cumulative response a fortiori reaches a maximum (numerically) after a finite number of steps beyond the initial period. Subsequently, the cumulative response begins actually to decrease (numerically). The danger signal is flashed when the model begins to yield positive values for any one of the terms in (20). Of course, if P_S , the price of substitutes, is assumed to increase at the same time, the time it takes any interim response to change from negative to positive will be that much longer.¹⁴ The same is true when

¹⁴Equation (19) tells us that when electricity price and the price of substitutes increase at the same rate, holding MA fixed, electricity demand remains unchanged. The reader should not confuse this result with that derived from (20). Indeed, (20) is homogeneous of degree minus 1 in prices, as we would expect.

But $\frac{\partial E_t^{M.A.}}{\partial \left(\frac{P_{E_t}}{P_{S_t}^{1/3}} \right)} = 0$ when electricity price and the price of substitutes increase at the same rate (then $\frac{P_{E_t}}{P_{S_t}^{1/3}}$ is a constant).

This is consistent with what (19) shows.

MA is allowed to increase. In fact, with sufficiently high rate of growth of MA, (20) will remain negative as long as that rate (of growth of MA) is maintained.

Hence, to simulate meaningfully with the model, one would want first to examine the results from (20) for any combination of postulated changes in the predetermined variables. The simulation should not be carried out beyond (and

preferably stopped before) the time period T when $\frac{\partial E_T^{MA}}{\partial P_{e_t}}$ ceases to be negative.¹⁵

Similar remarks apply to the various multipliers of E_T^{MA} with respect to MA_t , $t = 1, \dots, T$. For meaningful simulation results, we want (21) to be positive for each province over the whole time period for which the simulation is carried out. Here again, with P_{e_t} rising (holding MA and P_S fixed, the cumulative response reaches a maximum after a finite number of steps beyond the initial period. Subsequently the cumulative response begins actually to decline. The time it takes this to happen may be prolonged if P_S increases at the same time as electricity price increases. The opposite is true when MA increases at a faster rate, since the quadratic term enters (in the case of electricity, oil and coal) with a negative sign.

Taken together, (20) and (21) determine the maximal time horizon over which we could simulate meaningfully the behaviour

¹⁵We could write (20) as a function of the rate of change in the price of electricity, price of substitutes, and manufacturing production, and solve for the time horizon T that would keep the first term in (20) smaller than or equal to zero--conditional on the initial value of electricity price, price of substitutes, and manufacturing production. The solution is not straightforward, however, because of the exponential terms with which the rates of growth enter. It is much easier, however to compute (20) for any postulated rate to change in the explanatory variables and determine the time T when the sign of (20) changes from negative to positive.

of the manufacturing demand for electricity under alternative assumptions about the behaviour of the predetermined variables. The maximal horizon is the smaller of the two time horizons during which (20) remains negative and (21) remains positive.

To illustrate how the procedure works, let me give a concrete example that I worked out for the quadratic model of the industrial demand of gas, and which I estimate initially for 1960-1968 for Quebec, Ontario, Manitoba, Saskatchewan, Alberta, and British Columbia. The main difference between this model and the electricity model we have been discussing, is that in the case of gas we constrained κ to 1. But with $\kappa > 0$, this does not affect the essence of the procedure.

Taking 1969 as the base year, I calculated $\frac{\partial G_T}{\partial p_{g_t}}$ and $\frac{\partial G_T}{MA_t}$ (where G_t stands for the industrial demand for gas) using a 4% rate of growth for real manufacturing production in combination with a 5% rate of growth of gas price and zero change in the price of gas substitutes. The results are shown in Table 2.¹⁶ The upper panel of the table shows the various price multipliers. It can be seen that the multipliers increase (numerically) from the first to the second year, but beyond that, they begin to decrease in all provinces except in Ontario. Hence the size of MA is so large that with a 4% growth rate of MA, the response of gas demand to gas price continued to increase. (Recall in the case of gas, $\kappa = 1$.) The last row of the upper panel shows the $\frac{\partial G_T}{\partial p_{g_T}}$ for each province. It can be seen that by 1979 the interim multiplier has decreased to a point where $\frac{\partial G_T}{\partial p_{g_t}}$ will no longer be negative in every

¹⁶The results in this table are shown to three decimal points, mainly to illustrate the point about the determination of the time horizon.

Table 2. Impact multipliers and interim multipliers (in trillion BTU) of the industrial demand for gas with respect to gas price and real manufacturing production. Initial year is 1969. Rate of growth of real manufacturing production = 4%; increase in gas price = 5%; increase in the price of substitutes = 0%.

| $\partial G_T / \partial p_{g_t}$ | | | | | | |
|-----------------------------------|--------|---------|----------|--------------|---------|------------------|
| Year | Quebec | Ontario | Manitoba | Saskatchewan | Alberta | British Columbia |
| 1970 | -0.253 | -0.571 | -0.104 | -0.095 | -0.131 | -0.111 |
| 1971 | -0.484 | -1.165 | -0.185 | -0.178 | -0.259 | -0.191 |
| 1972 | -0.470 | -1.181 | -0.169 | -0.170 | -0.257 | -0.170 |
| 1973 | -0.453 | -1.198 | -0.152 | -0.162 | -0.255 | -0.148 |
| 1974 | -0.435 | -1.214 | -0.134 | -0.153 | -0.253 | -0.124 |
| 1975 | -0.416 | -1.231 | -0.115 | -0.144 | -0.251 | -0.099 |
| 1976 | -0.396 | -1.248 | -0.095 | -0.134 | -0.249 | -0.073 |
| 1977 | -0.374 | -1.266 | -0.074 | -0.124 | -0.247 | -0.045 |
| 1978 | -0.351 | -1.283 | -0.052 | -0.113 | -0.244 | -0.016 |
| 1979 | -0.169 | -0.646 | -0.021 | -0.054 | -0.122 | -0.001 |

| $\partial G_T / \partial MA_t$ | | | | | | |
|--------------------------------|--------|---------|----------|--------------|---------|------------------|
| Year | Quebec | Ontario | Manitoba | Saskatchewan | Alberta | British Columbia |
| 1970 | 0.228 | 0.633 | 0.350 | 0.460 | 0.637 | 0.246 |
| 1971 | 0.198 | 0.620 | 0.331 | 0.446 | 0.632 | 0.220 |
| 1972 | 0.167 | 0.607 | 0.310 | 0.432 | 0.626 | 0.193 |
| 1973 | 0.135 | 0.593 | 0.289 | 0.417 | 0.621 | 0.165 |
| 1974 | 0.101 | 0.577 | 0.266 | 0.401 | 0.614 | 0.135 |
| 1975 | 0.064 | 0.561 | 0.243 | 0.384 | 0.603 | 0.104 |
| 1976 | 0.026 | 0.543 | 0.218 | 0.366 | 0.601 | 0.071 |

province for T beyond 1979.¹⁷ This determines then a horizon of ten years (beginning in 1970 and ending in 1979), during which the model results will continue to make sense from the point of view of the effect of gas price on gas demand.

The lower panel of the table shows that beyond the first year, $\frac{\partial G_T}{\partial MA_t}$ declines steadily. The table also shows that by 1976 the interim multiplier has reached a point where $\frac{\partial G_T}{\partial MA_t}$ will no longer be positive in every province¹⁸ for T beyond 1976. This then determines a horizon of seven years, beginning in 1970.

The maximum horizon over which we could simulate meaningfully under the conditions postulated in Table 2 is then seven years--which is the smaller of the two time horizons determined by the two panels of the table. The purpose of the preceding discussion was simply to illustrate the procedure we used in determining the horizons over which the simulations were carried out.

III. Estimated Results for the Residential and Residential-Commercial Markets

Estimated results for the residential and the commercial markets are not complete. Work is still in progress on these markets. Table 3 below shows estimated results for the residential and commercial markets.

The hypothesis that an increase in the proportion of apartments in total dwellings tends to lower the response of demand to price is confirmed in the residential markets for

¹⁷ See $\frac{\partial G_T}{\partial p_g}$ in British Columbia.

¹⁸ See $\frac{\partial G_T}{\partial MA_t}$ in Quebec.

Table 3.

| RESIDENTIAL MARKETS 1960-1970 | |
|---|------------------------------|
| <u>Natural Gas:</u> | |
| $\Delta G_t = 2.99 - .45 \frac{P_{G_t}}{(P_0^P P_C^P P_E^P)_t^{1/3}} - .15 \text{Apt.}_t + .005 H0_t$ <p style="text-align: center;">(5.83) (1.10) (5.6) (6.32)</p> $- .04 G_{t-1}$ <p style="text-align: center;">(2.42)</p> | $\bar{R}^2 = .71$ D.F. = 61 |
| <u>Electricity:</u> | |
| $\Delta F_t = .39 - .06 \frac{P_{E_t}}{(P_0^P P_C^P P_G^P)_t^{1/3}} + .03 Y_t - .02 E_{t-1}$ <p style="text-align: center;">(2.35) (2.27) (3.04) (1.00)</p> | $\bar{R}^2 = .91$ D.F. = 62 |
| <u>Oil:</u> | |
| $\Delta O_t = 3.81 - 12.17 \frac{P_{O_t}}{(P_0^P P_E^P P_C^P)_t^{1/3}} + 0.5 Y_t + .39 \frac{P_{O_t}}{(P_G^P P_E^P P_C^P)_t^{1/3}}$ <p style="text-align: center;">(2.07) (3.11) (2.21) (3.54)</p> $\text{Apt.}_t \quad .03 \quad O_{t-1}$ <p style="text-align: center;">(1.48)</p> | $\bar{R}^2 = .25$ D.F. = 106 |
| COMMERCIAL MARKETS 1960-1970 | |
| <u>Natural Gas:</u> | |
| $\Delta G_t = 1.69 - 2.92 \frac{P_{G_t}}{(P_0^P P_C^P P_E^P)_t^{1/3}} - .17 \left[\frac{P_{G_t}}{(P_0^P P_C^P P_E^P)_t^{1/3}} \right] \text{Apt.}_t$ <p style="text-align: center;">(2.10) (1.01) (3.85)</p> $+ .001 P0_t$ <p style="text-align: center;">(7.74)</p> | $\bar{R}^2 = .49$ D.F. = 62 |

Note: Apt. = % apartments in total dwellings;
 H0_t = number of households, in thousands;
 P0_t = population, in thousands;
 Y_t = two-year average real personal income, at t and t - 1,
 in billion \$ of 1961 prices; and
 Y_t = two-year average personal income, at t and t - 1, in
 current billion \$.

oil (and the commercial markets for gas). In general, the effect of an apartment is to create a buffer between the purchaser of the energy resource (the tenant) and the purchaser of the equipment (the owner). By divorcing the payer of the oil bill from the investor in the oil-using equipment, apartment dwelling tends to reduce the link between the replacement and expansion demand for oil, on the one hand, and the price of oil, on the other hand.

We have estimated a similar relationship (as for oil) for the residential demand for natural gas; but the estimates were not meaningful. The alternative results reported in Table 3 for the residential demand for natural gas reflect the fact that an increase in the share of apartments tends to reduce the demand for gas. In itself this is not surprising, since it takes less to heat an apartment than a house. We have not been able, however, to find a convincing reason for the different effect exerted by apartments on the demand for natural gas and oil in the residential market. One reason may very well be the fact that data for the residential demand for natural gas do not include gas consumed by households residing in apartments. When a household changes dwelling from a house to an apartment (and continues to use natural gas) it is reported in many cases (there is no uniformity in reporting) under commercial demand (not residential anymore). Hence, a switch to apartments appears as a net loss to the residential market. The fact that natural gas demand by apartment households is not always included under residential demand may account for the fact that the estimates were not meaningful when we calculated (for residential demand for natural gas) an equation comparable to the residential demand for oil.

IV. Simulation

In this section I show selected simulation results which focus on the effect of price on demand. Figures 4 to 6 are based on earlier estimates (1960-1968) of the industrial demand

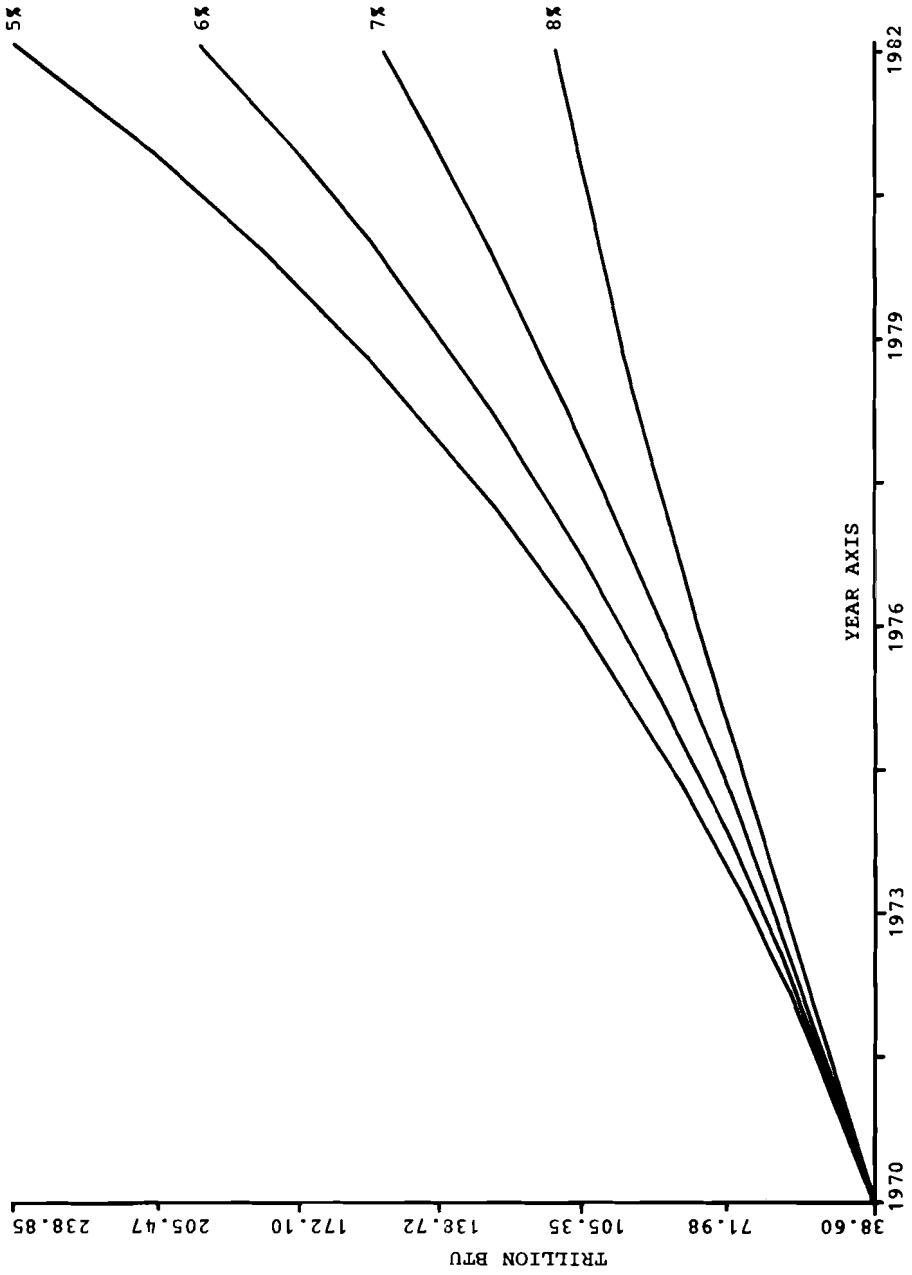

Figure 4. Simulation results of the industrial demand for gas in Quebec: real manufacturing production increasing at the historical rate of the sixties; price of substitutes increasing by 5% annually above their 1969 level; and gas price increasing above its 1969 level by the percentages indicated.

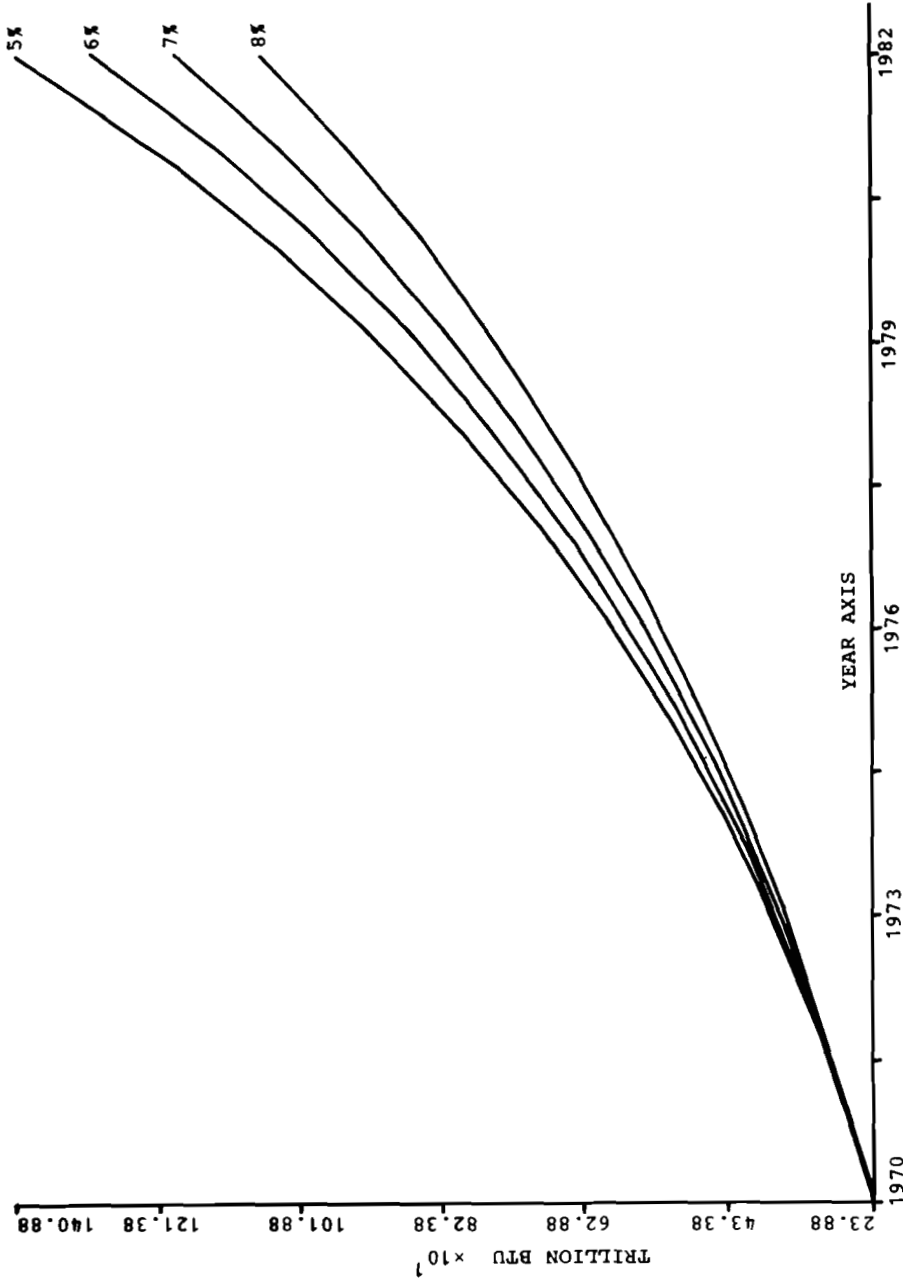

Figure 5. Simulation results of the industrial demand for gas in Ontario: real manufacturing production increasing at the historical rate of the sixties; price of substitutes increasing by 5% annually above their 1969 level; and gas price increasing above its 1969 level by the percentages indicated.

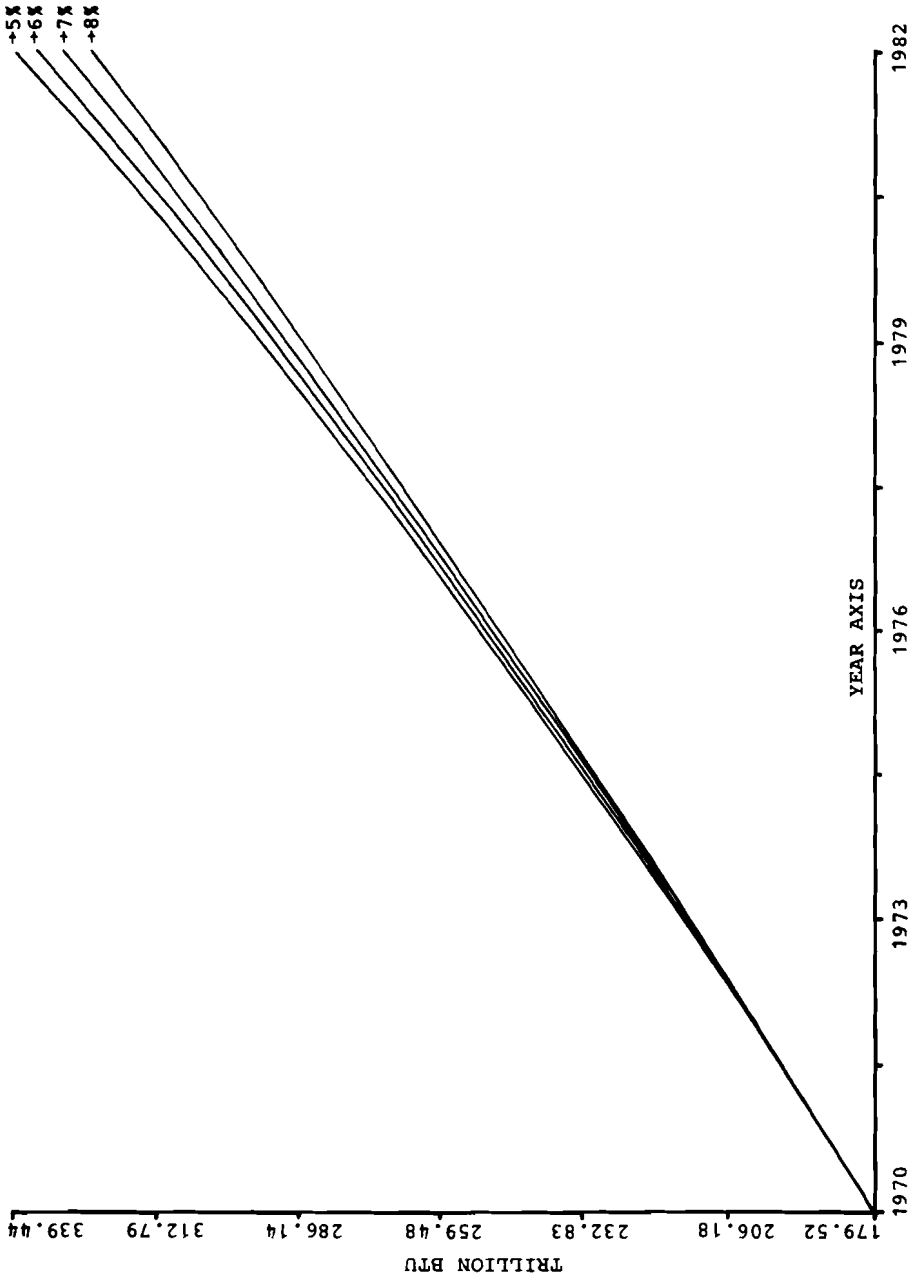

Figure 6. Simulation results of the industrial demand for gas in Alberta: real manufacturing production increasing at the historical rate of the sixties; price of substitutes increasing by 5% annually above their 1969 level; and gas price increasing above its 1969 level by the percentages indicated.

for natural gas. Note the effect of a change in gas price on the demand in Quebec. In Ontario the response is even larger. (In fact we had to plot Ontario on 1/10 of the scale used for Quebec or Alberta.) Contrast the sizeable effect of price on the demand in Ontario with the very small effect of price on demand in Alberta. (It is interesting to see in this context the constant strife between Alberta and Ontario about raising the price of natural gas.) From the point of view of planning, regional patterns such as the one displayed by Alberta versus Ontario are very important to unveil. In the case of Alberta, a policy maker can say with confidence that he has a handle on future demand. Not so in Ontario. Greater care and contingency planning is needed here. Small discrepancies between the estimated and actual prices may mean tremendous differences between anticipated and actual demand in the future.

Figures 7 and 8 show a different simulation format. Here we plotted all provinces on the same diagram to see each province in relation to the rest. In comparing the two diagrams, note in particular the relative position of Ontario and Quebec. An increase in the price of electricity is seen to affect demand in Ontario much more than in Quebec. In Figure 7 Ontario is seen to overtake Quebec around 1976 (both demand curves are almost linear); in Figure 8 Ontario's demand is seen to curve and to stay below Quebec's (possibly with increasing gap beyond 1980).

Figure 9 shows the aggregated demand for coal in all of Canada; in the aggregate coal is more sensitive to price than the rest of energy sources, which may say a great deal about the future demand for coal, if we could only overcome the problem of emission control in the near future.

Figure 10 shows a similar diagram for mining demand for oil; typically, mining demand for oil is more price-sensitive than mining demand for electricity, possibly because oil enters more as a source of heat and less as part of mining technology than electricity does.

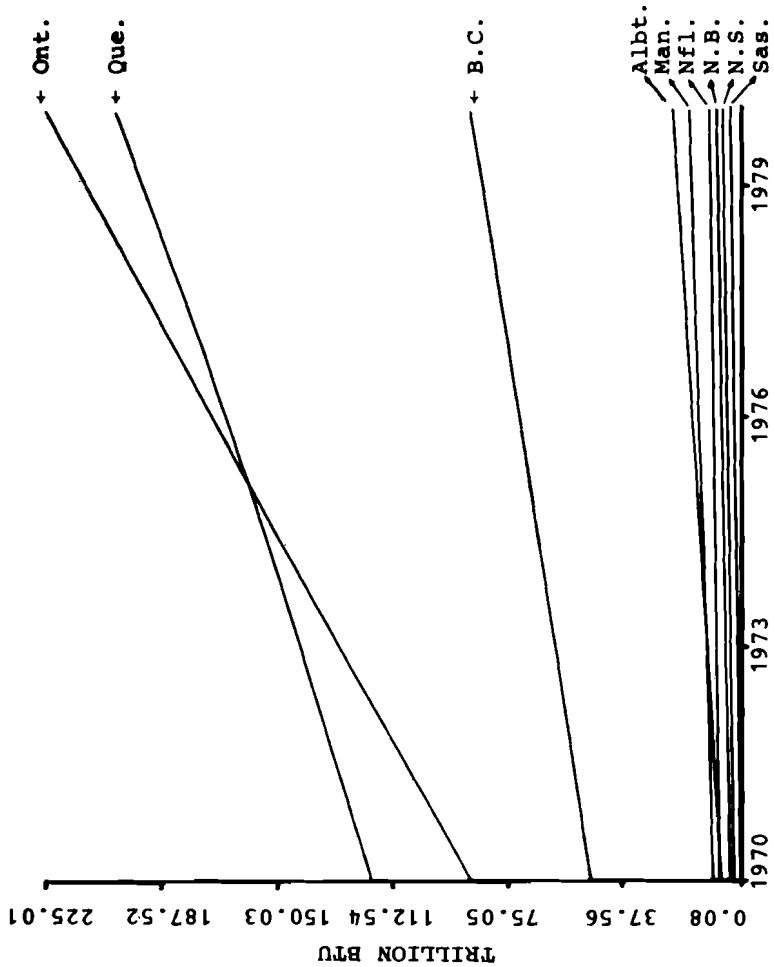

Figure 7. Simulation results for the manufacturing demand for electricity in Canada. Assumptions: price of electricity increase slower than the price of substitutes by one percent (base 1969-70); real manufacturing production (in 1961 prices) increasing by the rate of the 60's less one percentage point (base 1970).

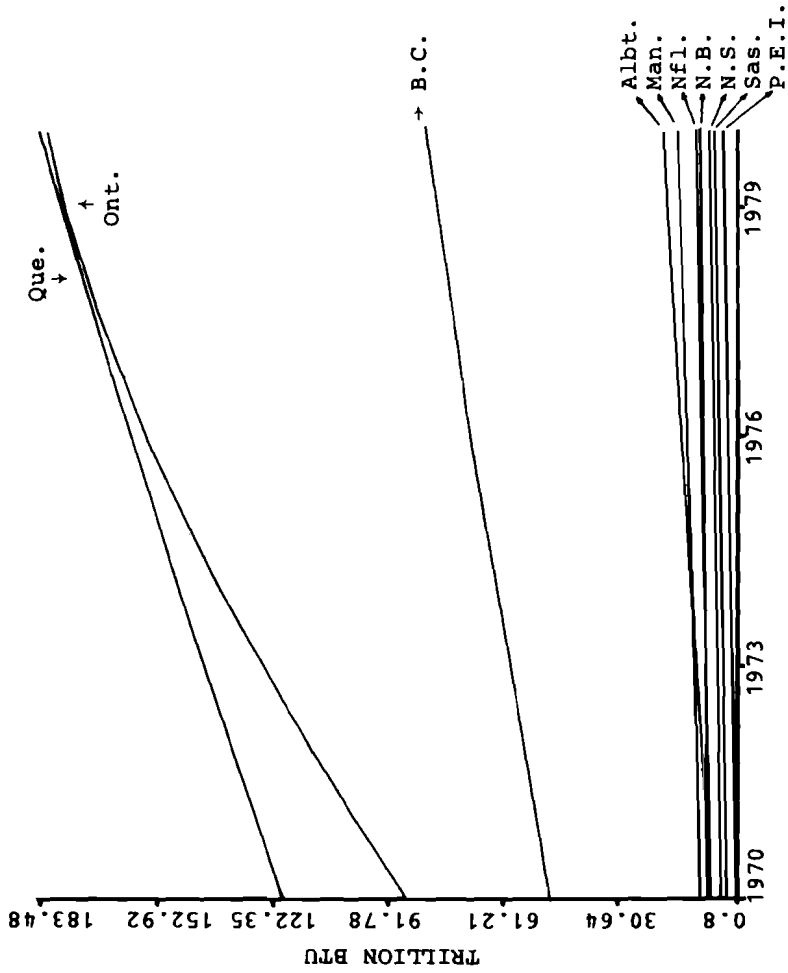

Figure 8. Simulation results for the manufacturing demand for electricity in Canada. Assumptions: price of electricity increase faster than the price of substitutes by one percent (base 1969-70); real manufacturing production (in 1961 prices) increasing by the historical rate of the 60's less one percentage point (base 1970).

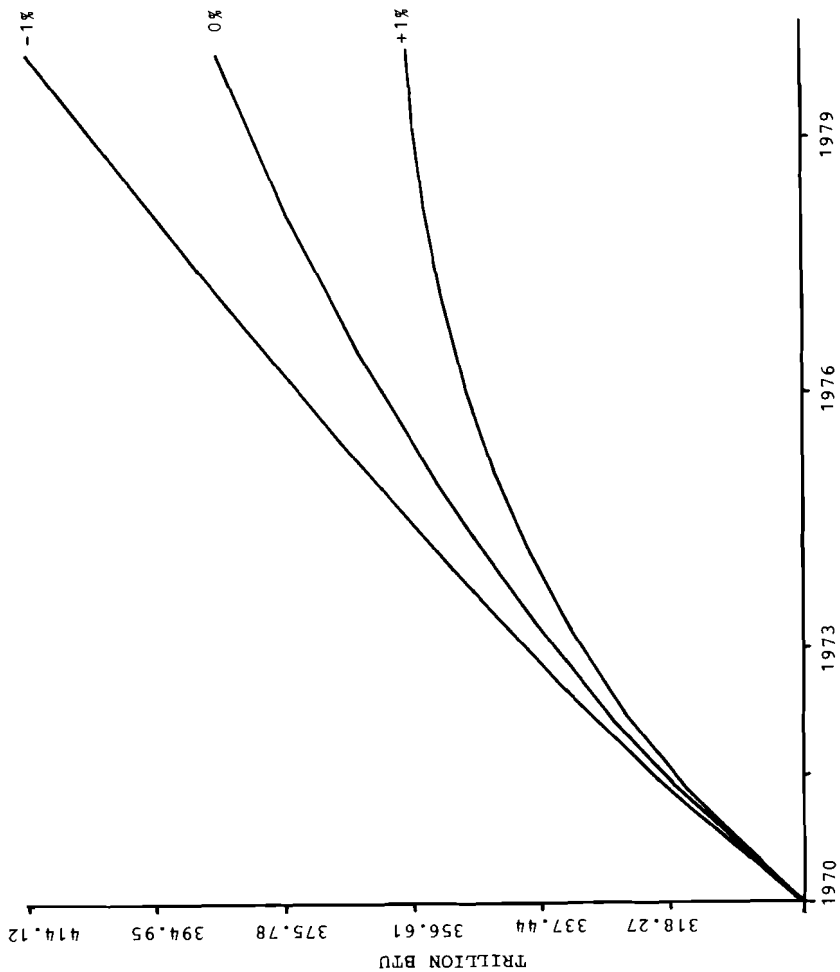

Figure 9. Simulation results for the industrial demand for coal in Canada. Assumptions: real manufacturing production increasing at the historical rate of the sixties less one percentage point (base 1970); price of coal increasing faster (slower) than the price of substitutes by the percentages indicated (base 1969-70).

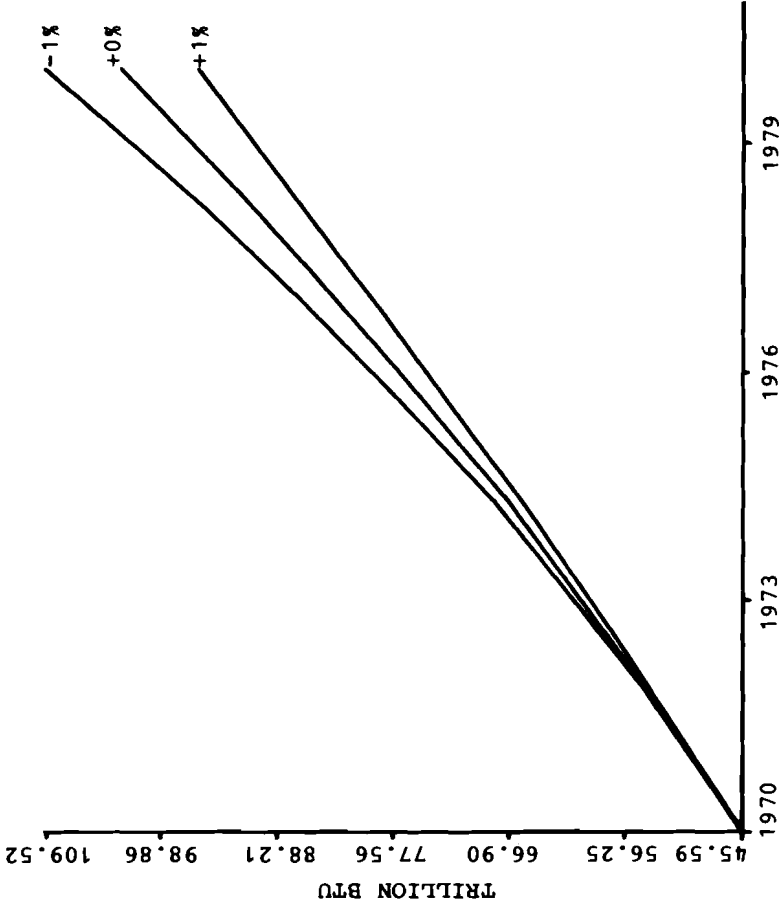

Figure 10. Simulation results for the mining demand for oil in Canada. Assumptions: real mining rate production increasing at the historical rate of the sixties less half percentage point (base 1969-1970); price of oil increasing faster (slower) than the price of substitutes by the percentages indicated (base 1969-1970).

Figures 11 to 14 were prepared in connection with the James Bay Hearings. Here I raised the price of the substitutes of electricity and held the price of electricity fixed at its 1970 level in order to estimate the maximum demand for electricity in Quebec under conditions most favorable to electricity demand.

For the combined residential-commercial markets hardly any price effect is discerned. This is quite understandable, since in the commercial markets (which make up approximately 2/3 of the combined residential-commercial markets) electricity has hardly any substitute (particularly in electronic equipment, which is a big consumer of electricity). Some responsiveness to price is present in the residential markets, perhaps reflecting the price responsiveness of the little electric space heating there is.

The manufacturing demand for electricity, however, is very price sensitive, as one might expect of electricity prices. Note also the diminishing effect of the price of substitutes on the demand for electricity. For the first 5% increase in the price, the increase in electricity demand is larger than the increase in demand associated with the second round of increase in the price of substitutes. This is as it should be. As the upper layers of demand for substitutes are shaved off, further cuts meet greater resistance and therefore require bigger boosts in prices.

Figures 15 and 16 (and the subsequent diagrams) were prepared in connection with the NEB Hearings on the future requirements of natural gas. The NEB asked, among other things, to forecast natural gas demand on the assumption that the price relationship that existed on May 15, 1974 will be maintained in the future (future demand under those price conditions are marked f) and on the assumption that the price of gas is boosted to a level that equates gas price with oil price on a BTU basis. Since NEB did not say over what time horizon this

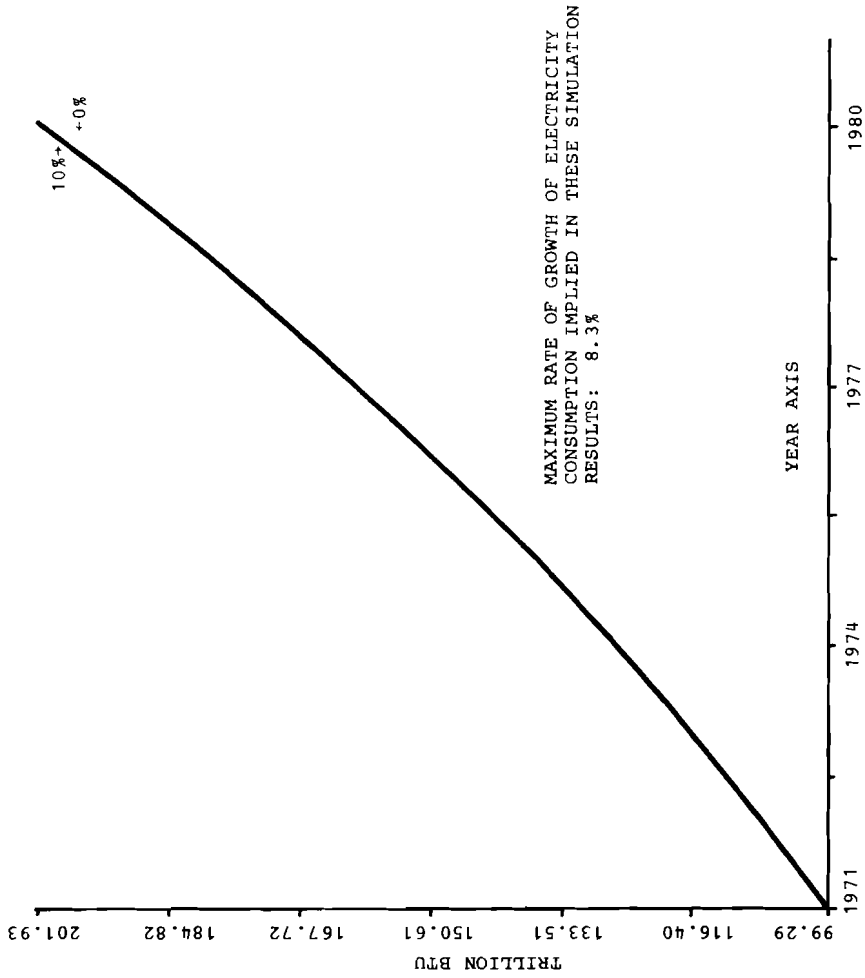

Figure 11. Simulation results for electricity demand in the residential commercial market in Quebec. Assumptions: medium to high personal income; electricity prices frozen at the 1970 level; and the prices of substitutes increasing by the percentages indicated. Base year is 1970.

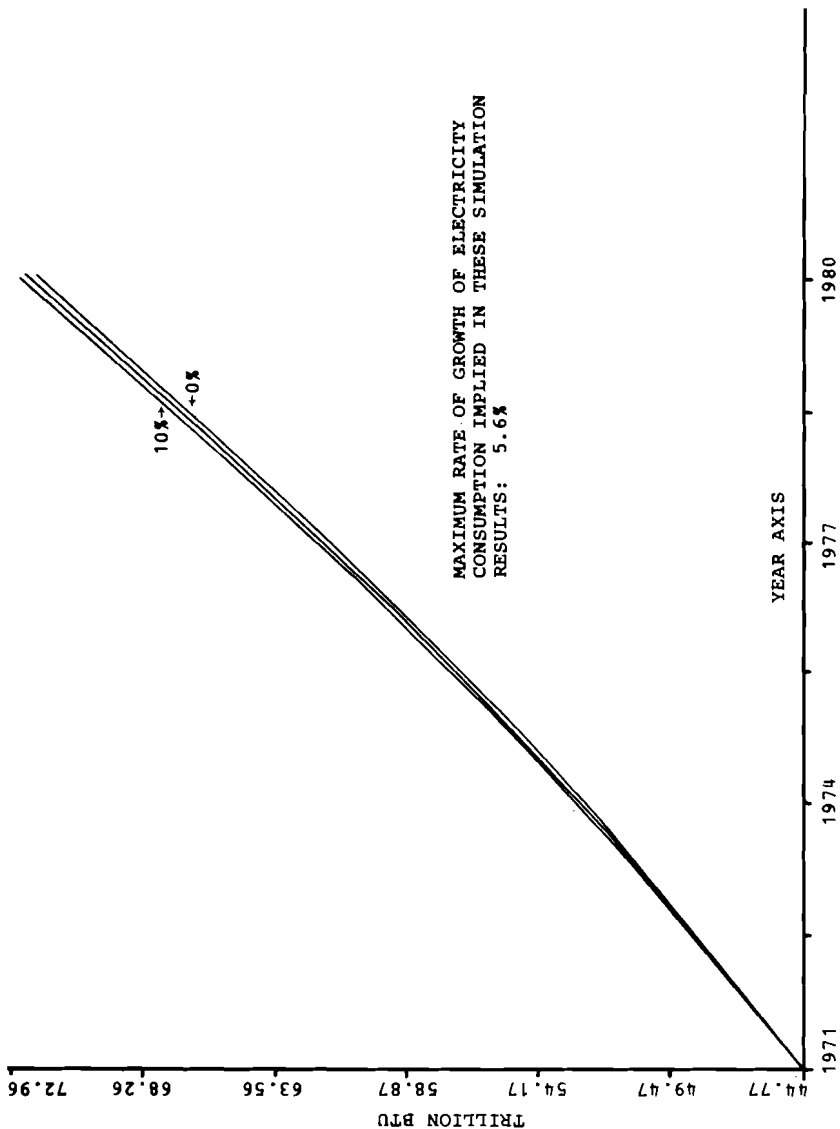

Figure 12. Simulation results for electricity demand in the residential market in Quebec. Assumptions: real manufacturing production increasing at prices frozen at the 1970 level; and the prices of substitutes increasing by the percentages indicated. Base year is 1970.

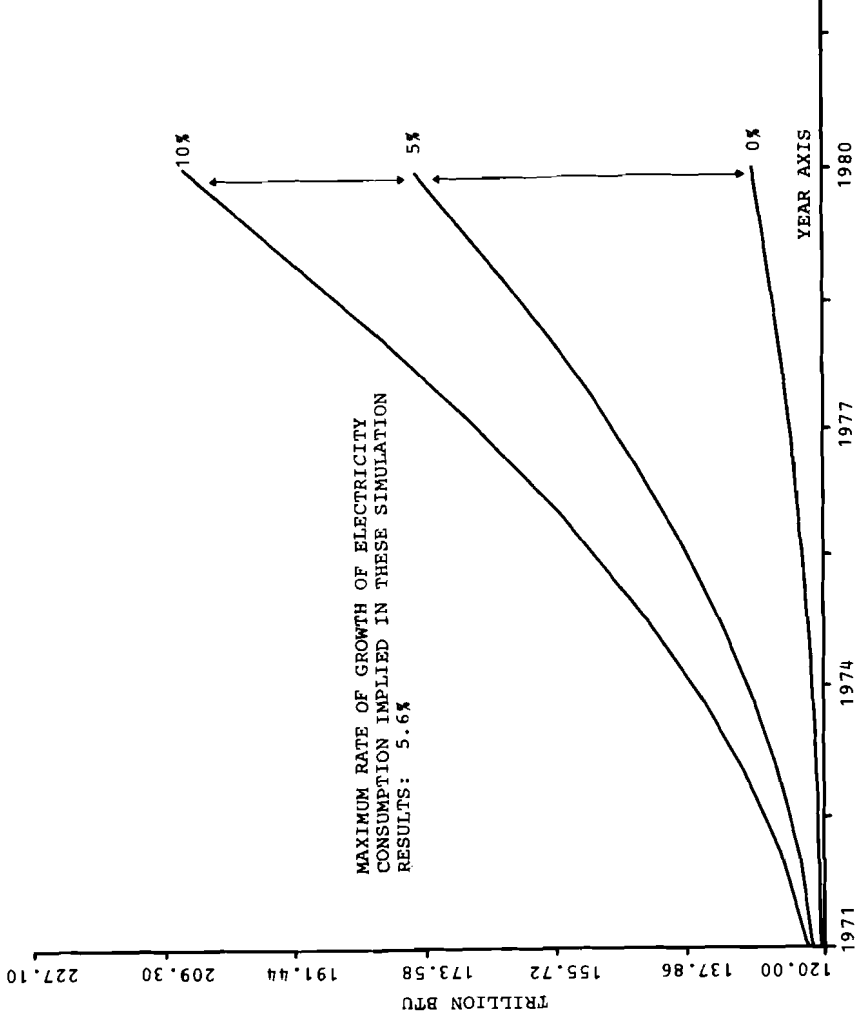
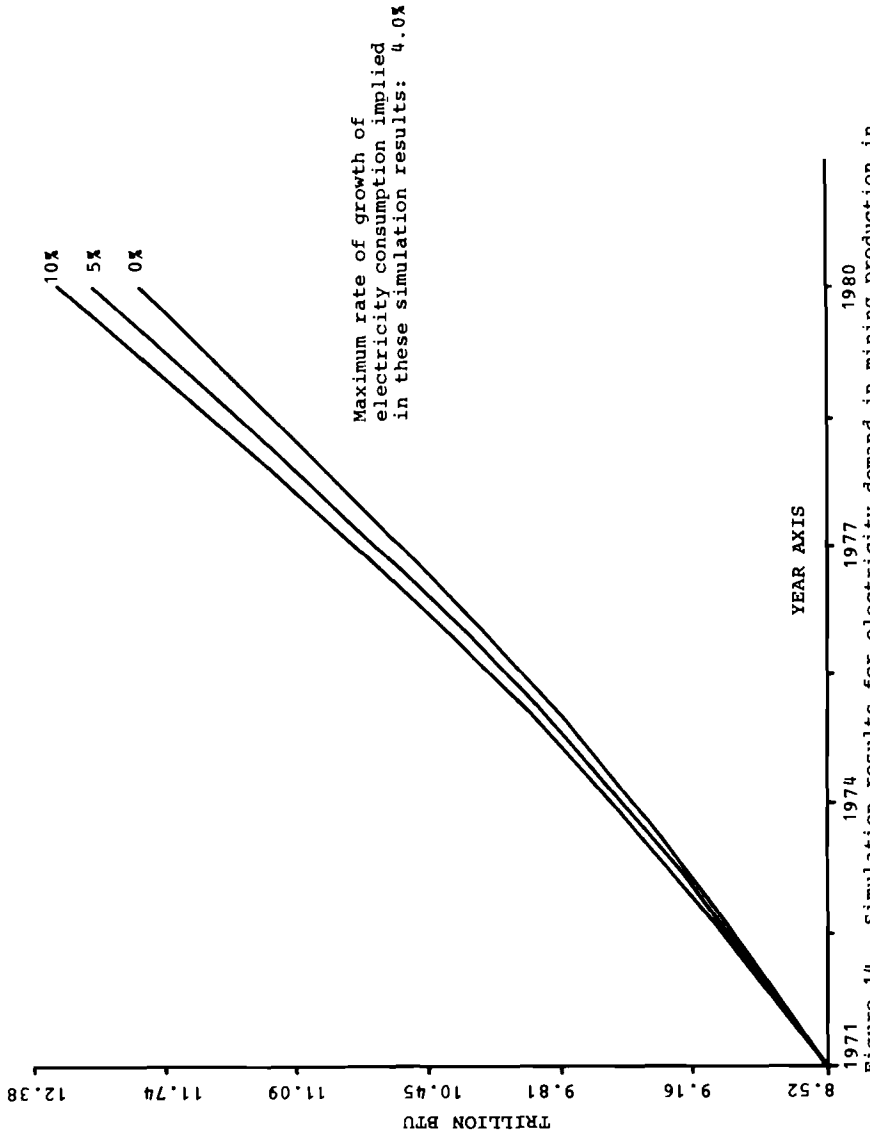

Figure 13. Simulation results for electricity demand in manufacturing production in Quebec. Assumptions: real manufacturing production increasing at an average rate of 5.6% per annum; electricity price frozen at its 1970 level; and the prices of substitutes increasing annually by the percentages indicated. Base year is 1970.



Maximum rate of growth of electricity consumption implied in these simulation results: 4.0%

Figure 14. Simulation results for electricity demand in mining production in Quebec. Assumptions: real mining production increasing at an average rate of 6.3% per annum; electricity price frozen at its 1970 level; and the prices of substitutes increasing annually by the percentages indicated. Base year is 1970.

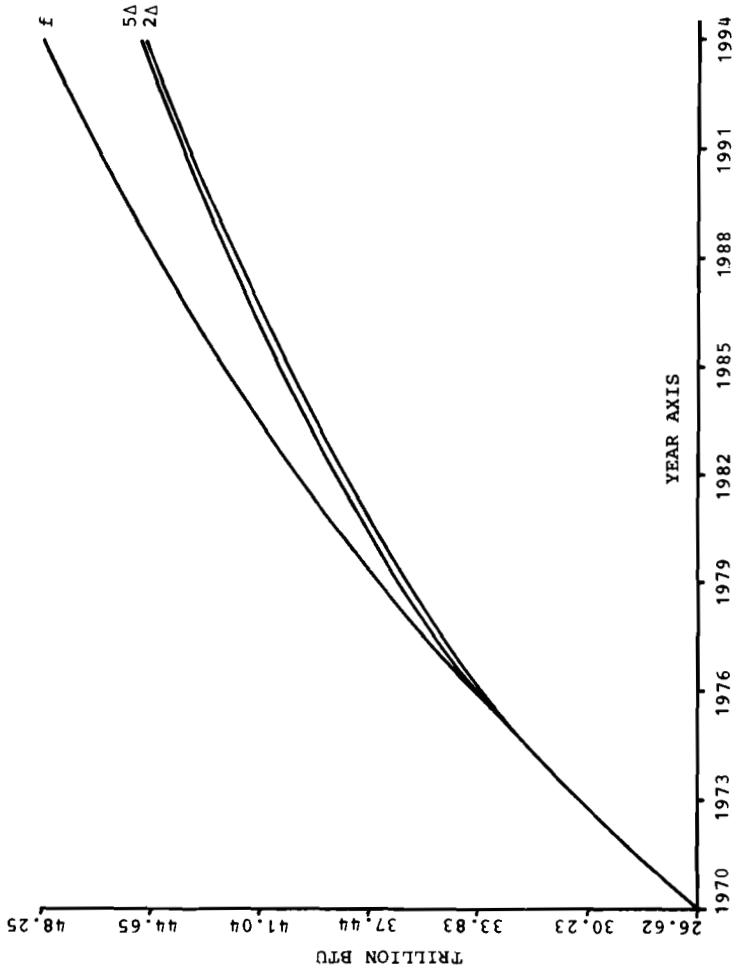

Figure 15. British Columbia. Simulation results for the residential demand for natural gas. Assumptions: Price of oil, coal, and electricity fixed at their level of May 15, 1974. Ratio of apartments to total dwellings increasing annually (from 1970 on) by 3.06% and total number of households increasing by 3.35% annually. Price of gas fixed at its level of May 15, 1974 (curve labelled f, for fixed). Price of gas boosted over a two-year period (1975/76) to equate it to oil price on May 15, 1974 (curve labelled 2Δ). Price of gas boosted over a five-year period (1975/79) to equate it to oil price on May 15, 1974 (curve labelled 5Δ).

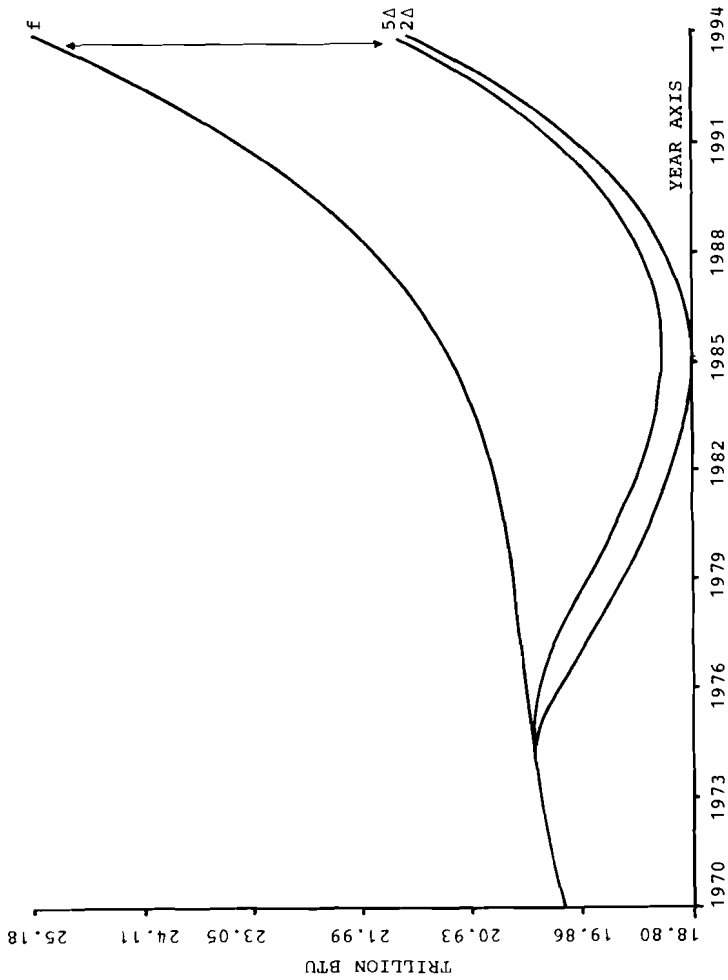

Figure 16. Manitoba. Simulation results of the residential demand for natural gas. Assumptions: Price of oil, coal, and electricity fixed at their level of May 15, 1974. Ratio of apartments to total dwellings increasing annually (from 1970 on) by 3.08% & total number of households increasing by 1.61% annually. Price of gas fixed at its level of May 15, 1974 (curve labelled \bar{f} , for fixed). Price of gas boosted over a two-year period (1975/76) to equate it to oil price on May 15, 1974 (curve labelled 2 Δ). Price of gas boosted over a five-year period (1975/79) to equate it to oil price on May 15, 1974 (curve labelled 5 Δ).

increase is to take place, I boosted the price of gas to the equivalent of the price of crude oil over a two year period (curve marked 2Δ) and alternatively over a five year period (curve marked 5Δ).

For British Columbia the 2Δ and 5Δ boost are seen to slow down the growth of the residential demands for gas, but not by terribly much in the residential markets. In Manitoba, however, the 2Δ and 5Δ increases are seen to have a tremendous effect on the demand for gas. Even with a recovery beginning in 1985, the savings by 1994 remain very large. A drastic increase in price could affect even captive demand. It is important to realize this point. A big enough increase in energy price can restrain energy even in relatively short time. The cost, however, may be a great deal of hardship to the public. (I regret the plotting routine did not plot from zero because of the size of the diagrams.)

Figure 17 shows the commercial demand for natural gas for all provinces plotted on the same chart with 2Δ . Except for Ontario where the hump appears around 1976, followed by continued growth the commercial demand slumps even in Alberta and finally dries up in the rest. With 5Δ (see Figure 18), the picture is essentially the same; the only difference is that the outcome takes slightly longer time to materialize.

Figure 19 shows the aggregated commercial demand in Canada under the three price scenarios. It is clear that in the short run the drop in demand associated with 2Δ price increase is much larger than the drop associated with 5Δ (see the interval 1976-1981). Over the long run, however, the difference is not that big, but in comparison with demand under the price relationship that prevailed in May 1974, demand under 2Δ or 5Δ is less than a third of what it would have been in the early nineties.

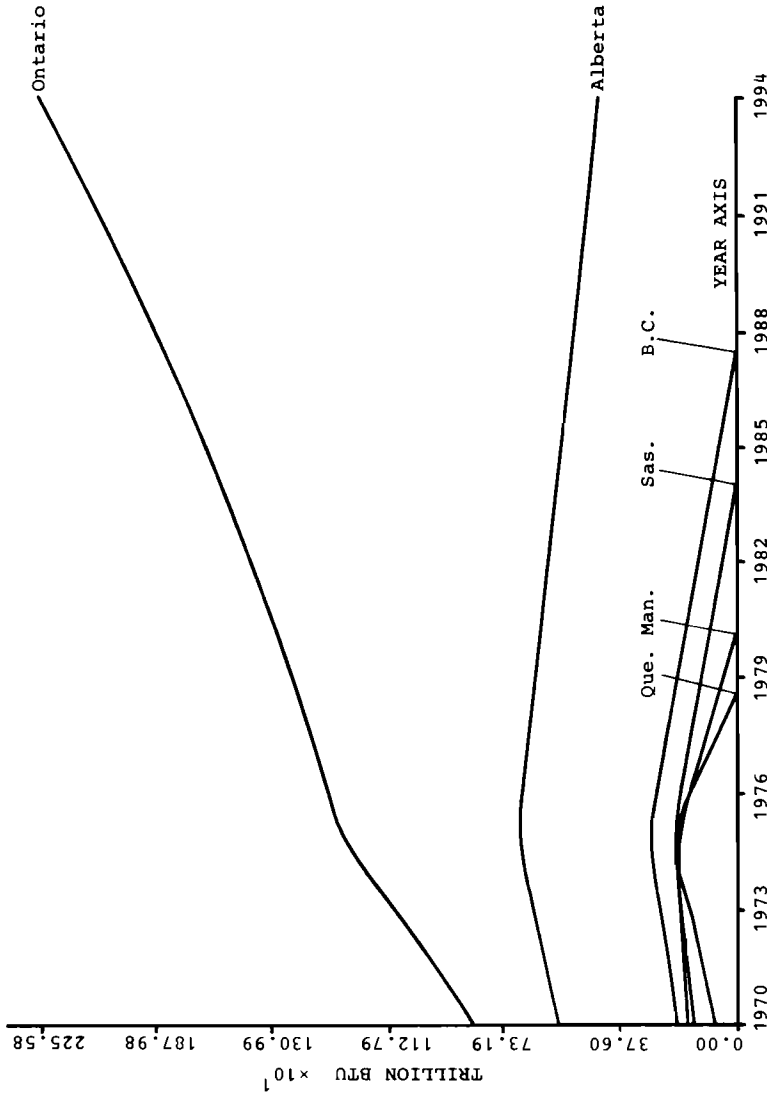

Figure 17. Canada. Simulation results for the commercial demand for natural gas in Canada. Assumptions: Price of oil, coal, and electricity are fixed at their level of May 15, 1974. Price of gas boosted over a two-year period (1975, 1976) to equate it to oil price of May 15, 1974. Percentage of apts. to dwellings, and population, respectively, increasing from 1970 on at the following rates. Quebec: Apt. 1.00%, P. 1.00%; Ontario: Apt. 2.32%, P. 2.29%; Manitoba: Apt. 1.00%, P. 0.71%; Saskatchewan: Apt. 2.025%, P. 0.41%; Alberta: Apt. 1.16%, P. 1.20%; British Columbia: Apt. 3.06%, P. 3.05%.

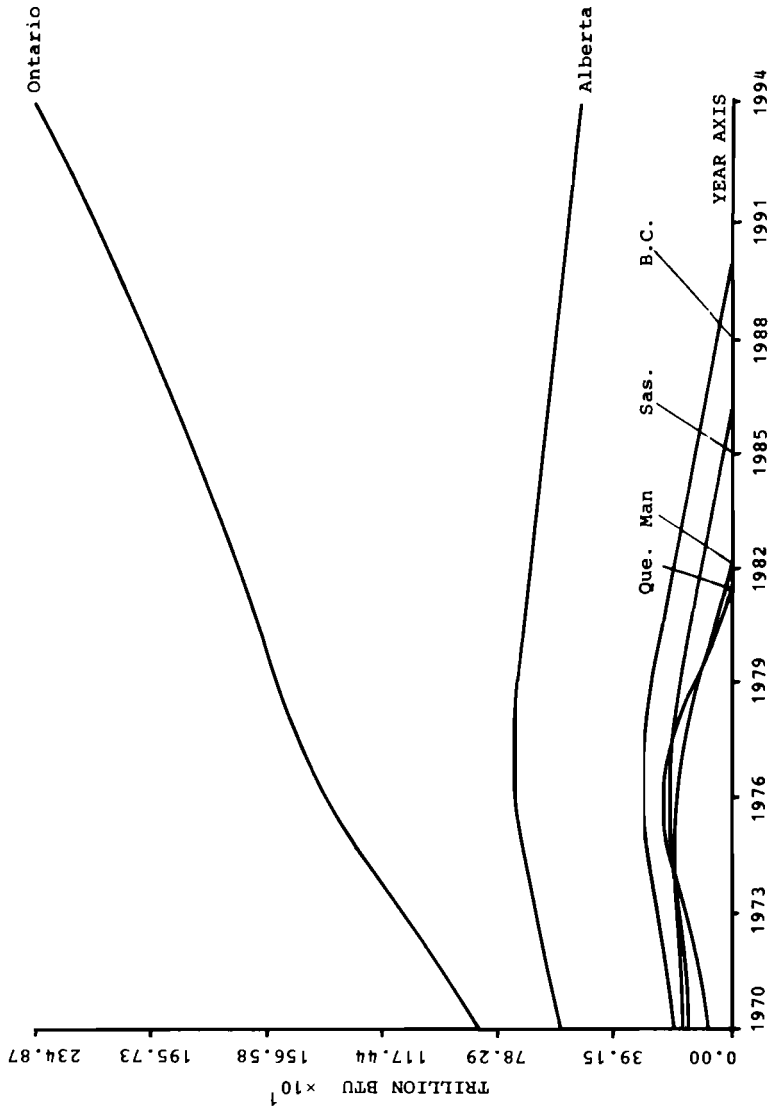

Figure 18. Canada. Simulation results for the commercial demand for natural gas in Canada. Assumptions: Price of oil, coal, and electricity are fixed at their level of May 15, 1974. Price of gas boosted over a five-year period (1975, 1976, 1977, 1978, and 1979) to equate it to oil price of May 15, 1974. Ratio of apt. to dwellings, and population, respectively, increasing from 1970 on at the following rates. Quebec: Apt. 1.10%, P. 1.00%; Ontario: Apt. 2.32%, P. 2.29%; Manitoba: Apt. 1.00%, P. 0.71%; Saskatchewan: Apt. 2.025%, P. 0.41%; Alberta: Apt. 1.16%, P. 1.20%; British Columbia: Apt. 3.06%, P. 3.05%.

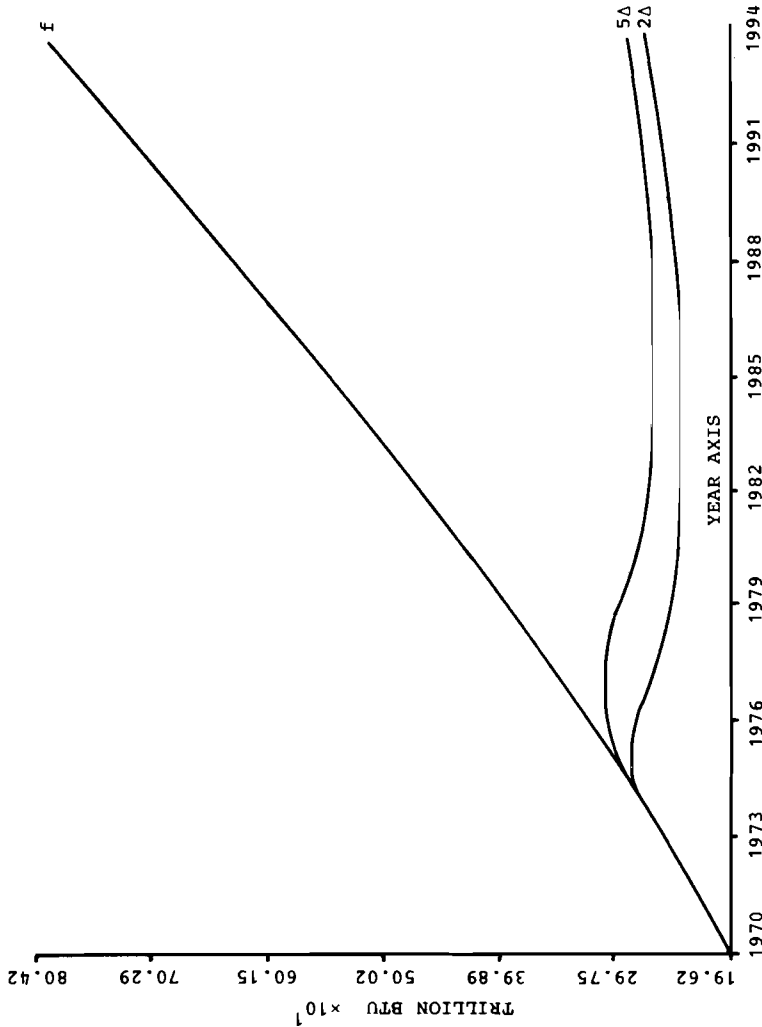

Figure 19. Canada. Aggregated simulation results for the commercial demand for natural gas in six provinces: Quebec, Ontario, Manitoba, Saskatchewan, Alberta, and British Columbia. Assumptions: price of oil, coal, and electricity fixed at their level of May, 15, 1974. Ratio of apartments to dwellings, and population, respectively, increasing from 1970 on at the following rates. Quebec: Apt. 1.10%, P. 1.00%; Ontario: Apt. 2.32%, P. 2.29%; Manitoba: Apt. 1.00%, P. 0.71%; Saskatchewan: Apt. 2.025%, P. 0.41%; Alberta: Apt. 1.16%, P. 1.20%; British Columbia: Apt. 3.06%, P. 3.05%. Price of gas fixed at its level of May 15, 1974 (curve labelled f, for fixed); price of gas boosted over a two-year period (1975-1976) to equate it to oil price of May 15, 1974 (curve labelled 2Δ); price of gas boosted over a five-year period (1975, 1976, 1977, 1978, and 1979) to equate it to oil price of May 15, 1974 (curve labelled 5Δ).

The tremendous sensitivity of the industrial demand for energy to energy price is illustrated in Figure 20 for Ontario. For demand in all markets combined, the picture is essentially the same (see Figure 21) because of the predominance of the industrial demand in the total.

All of the simulation results tend to underestimate the total price effect on demand. The model I described served primarily as a satellite model. There was no econometric model of the economy that is detailed enough and which was equipped to process and feed back information generated by this model. Because of the lack of feedback effect, the adverse effect of the secondary wave of price increase on demand (due to a slow down of economic activity) is not reflected in the model.

Allowing for the fact that the simulation results I showed tend to underestimate the effect of energy price on demand, we can summarize the major points of the simulation results we have seen so far:

- 1) there are regional differences in the responsiveness of energy demand to energy price;
- 2) in the short run the responsiveness of energy demand to energy price is fairly small, although even here large price increases could have a substantial effect, perhaps at the cost of a great deal of hardship to the public;
- 3) in the long run, energy demand is sensitive, often extremely so, to price variations;
- 4) typically, the manufacturing demand is much more sensitive than either the mining, commercial or residential demand for energy.

These are important policy implications to these results, particularly in the use of energy price as a tool for restraining energy demand.

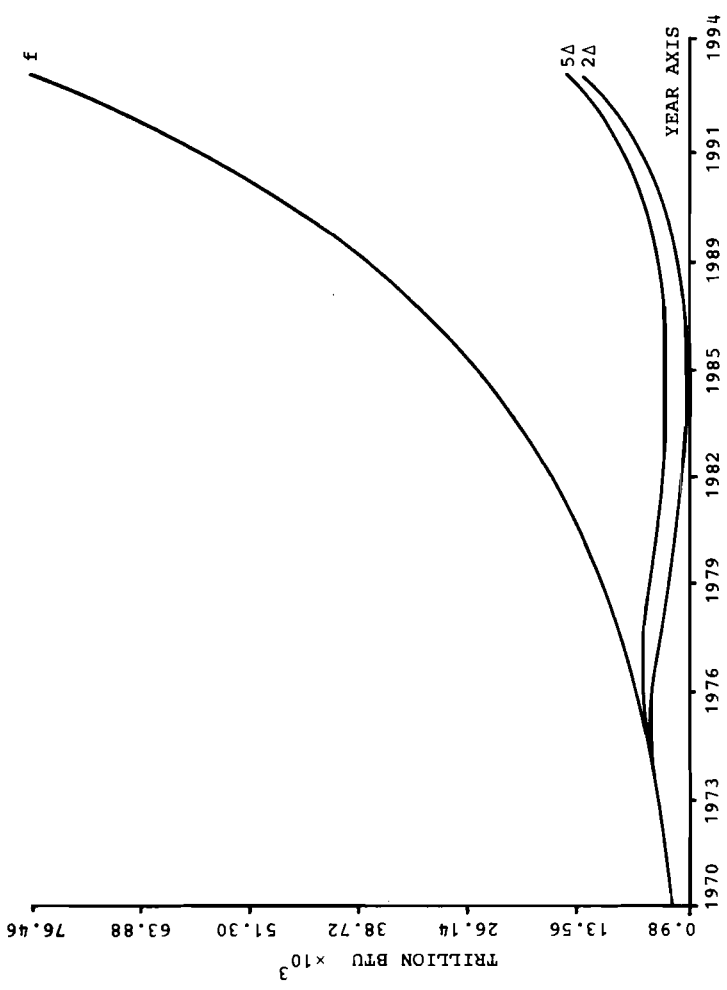

Figure 20. Ontario. Simulation results for the industrial demand for natural gas. Assumptions: Price of oil, coal, and electricity at their level of May 15, 1974. Real manufacturing production increasing at 7.2% annually. Price of gas fixed at its level of May 15, 1974 (curve labelled f, for fixed). Price of gas boosted over a two-year period (1975/76) to equate to oil price of May 15, 1974 (curve labelled 2Δ). Price of gas boosted over a five-year period (1975/79) to equate to oil price of May 15, 1974 (curve labelled 5Δ).

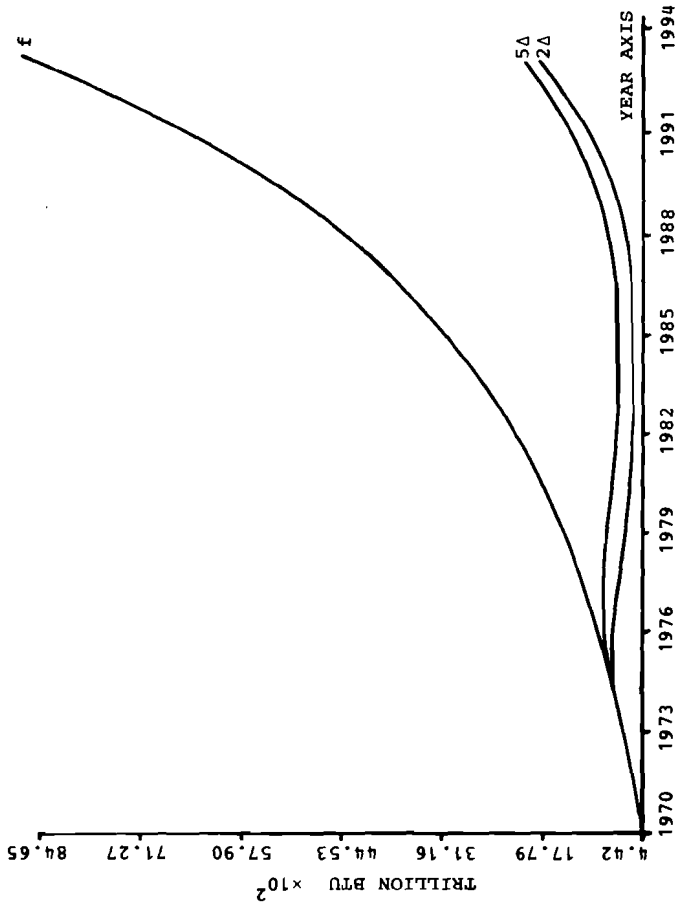

Figure 21. Ontario. Simulation results for the aggregated demand (inclusive of losses and adjustments) in the residential, commercial, industrial, and electrical utilities markets for natural gas. Assumptions: Price of oil, coal, and electricity fixed at their level of May 15, 1974. Following rates of increase used from 1970 on: Ratio of apartments to total dwellings increased by 2.32% annually. Number of households increased by 3.12% annually. Population increased by 2.29% annually. Real manufacturing production increased by 7.20% annually. Price of gas fixed at its level of May 15, 1974 (curve labelled f, for fixed). Price of gas boosted over a two-year period (1975-1976) to equate it to oil price on May 15, 1974 (curve labelled 2Δ). Price of gas boosted over a five-year period (1975-1979) to equate it to oil price on May 15, 1974 (curve labelled 5Δ).

References

- [1] Allen, R.G.D. Mathematical Economics. London, MacMillan & Co. Ltd., 1963.
- [2] Balestra, P., and Nerlove, M. "Pooling Cross Section and Time Series Data in the Estimation of a Dynamic Model: The Demand for Natural Gas." Econometrica (July 1966), 585-612.
- [3] Christ, Carl. Econometric Models and Methods. New York, John Wiley & Sons, 1966.
- [4] Dhyrnes, P.F., and Kurz, M. "Technologies and Scale in Electricity Generation." Econometrica (July 1964), 287-315.
- [5] Federal Power Commission. "A Study of the Demand of Gas to 1970." Testimony by Sherman Clark et al. in the Matter of Area Rate Proceedings, FPC Docket AR61-2, 1963. See also various other testimonies by Clark before the FPC beginning with Permian Basin Case, 1961.
- [6] Fisher, F.M., and Kaysen, C. The Demand for Electricity in the U.S. Amsterdam, North Holland Publishing Co., 1962.
- [7] Houthakker, H.S., and Taylor, L.D. The Consumer Demand in the U.S., 1959-1970, Analysis and Projection. Cambridge, Massachusetts, Harvard University Press, 1966.
- [8] Kaplan, W. Ordinary Differential Equations. Reading, Massachusetts, Addison Wesley Publishing Co., 1961.
- [9] Khazzoom, J. Daniel. "An Econometric Model of the Demand for Energy in Canada, 1960-1968." Unpublished working paper in Econometric Studies presented at the February 1973 Conference on Energy, Massachusetts Institute of Technology.
- [10] Khazzoom, J. Daniel. "An Econometric Model of the Industrial Demand for Oil, Coal, and Electricity." Unpublished working paper in Econometric Studies, Department of Economics, McGill University, 1974.

- [11] Khazzoom, J. Daniel. Review of P. Balestra, "The Demand for Natural Gas in the U.S." Econometrica (November 1970), 946-947.
- [12] Khazzoom, J. Daniel. "The FPC Staff Econometric Model of U.S. Natural Gas Supply." The Bell Journal of Economics and Management Science (Spring 1971), 51-93.

DiscussionSweeney

I have a few questions on the Khazzoom study. I liked his approach to the dynamics of adjustment, using the notion of captive versus free demand. But, I see some problems with the independent variables. In looking through the equations, I noticed that all energy prices were specified as ratios of the price of one fuel to another. As I see it, these equations imply that if the price of all energy products triples, the energy demands will not change. So while he tries to focus on interfuel substitution in captive demands, his specification excludes the notion that there may be "energy conservation." It seems unreasonable to assume that if all fuel prices go up people will continue to demand the same amount of energy, yet this is the way the equations are specified. Secondly, I was concerned about the insignificant statistics associated with many of the variables: I question the validity of using simulations based upon changing prices that were statistically insignificant.

Waverman

In his paper he performs dynamic analysis, and this is very important, although I really do not believe that thinking of it in terms of captive versus noncaptive is the essential answer. I cannot conceive how the interruptible gas market fits in, especially with dual burning equipment. These people can switch between alternative fuels depending on the price. For example in Saskatchewan 90% of the industrial gas market is interruptible because the price of interruptible gas was a legal quantity discount. How do we take account of all those things and how do you answer Taylor's problem whether to use the marginal or the average price?

Charpentier

I wonder what are the current studies on the lag of response to price changes. Almost all studies assume that the response is very quick but we know the lag is long.

Nordhaus

The question really revolves around the distributed lag of quantity response to a price change. That was part of Khazzoom's presentation in which on a theoretical level that distributed lag is involved with the life of the equipment. When the equipment falls apart the lag is over. It is a very important question, but my own intuition is that we do not have any definitive econometric information on the lag.

Sweeney

In the US there are poor data on the capital stock of energy-using equipment. One area where good data do exist is the use of automotive gasoline. The Federal Highways Administration in the US collects information on the number and the efficiency of cars. I have developed a vintage capital model of the automobile use of gasoline focusing on the dynamics of adjustment. This is the only endeavor in which I have been able to find enough reliable data on the capital stock of energy using equipment to reasonably expect to analyze dynamic issues.

Hutber

I wanted to say that we in the UK have done some analysis of demand, but we had to abandon it. We did the statistical work to try and estimate the parameters in the model and we did have some success in estimating these. We did it by adjusting the lag till we got the best fit. The thing that destroyed the model was not the problem of estimating lags. Rather we do not believe a unified demand modelling system can work. Instead, we use a complete range of models.

Khazzoom

I think the comments of both speakers are well taken. Sweeney's remark about the prices is well taken. I think this is a weak part of the model. It is a by-product of the fact that all of us who worked on energy for quite some time were caught all of a sudden in an unforeseeable price increase. The model started over five years ago. Energy costs were a very small fraction of the total. The worst that we could expect then was an increase in the price of energy of 10% annually which still is too small to have any significant feedback effect. When the embargo went into effect it was evident that this is not adequate. I am trying now to compensate for it by capturing the feedback effect through a national model. But some of the price coefficients are unstable. I try to allow for that by simulating with various specifications.

Nordhaus

This has been a very interesting set of comments. I would like to make a couple of remarks on these papers. One theme that is going to run through the entire Workshop is the distinction between the demand for energy and the interfuel substitution problem. That is just what Sweeney was referring to. My intuition is that you have a fighting chance to estimate the overall demand but that you are going to be plagued in any interfuel substitution estimates by all sorts of things. Just to take a simple example: In Western Europe you will never be able to predict on the basis of price alone the penetration of natural gas in the Netherlands. If you just look at what happened to prices and penetration rates you just never are going to be able to pick up the differential speeds of penetration.

There is another technique which is to try to use the econometric approach for overall energy demand and an engineering programming approach for the interfuel substitution. This is being done in a number of places mainly outside of North America. We need a diversified box of tricks in our forecasting. On the

question of Lencz's paper, as well as Chapman and Mount's forecast, and also Khazzoom in a sense, you are seeing very precise individual forecasts from a single specification, but when you put two specifications together you get tremendously wide variations in the forecasts. I think there are two things functioning here: one is what I call a Limits to Growth message, that you can get anything you want by specifying--or misspecifying--your functional form properly. The other thing is that I think econometricians are always underestimating their standard errors and their forecast errors. I think that is just what Sweeney was saying to Khazzoom, that because the standard errors are high, if he had not just put in the maximum likelihood forecast but also a confidence interval, the prediction would be much less precise.

III. INDIVIDUAL ECONOMIES

3.1 Eastern Europe and the USSR

Methods of Calculating Power Consumption
In the USSR

A. G. Vigdorichik and A. A. Makarov

Determination of future energy demand is one of the major tasks in the complex problem associated with the rational development of the energy sector. The difficulty of this task stems not only from methodological and informational difficulties, but also from a special responsibility inherent in forecasting; energy demand predetermines not only the overall level and growth rate of the energy sector but also to a large extent, its inner structure, that is, methods used in converting primary energy sources, composition of conversion plants and, indirectly, demands for a particular type of primary energy resources.

The determining influence of the scope and structure of energy demand on the nature of overall development of the energy sector makes the task involved in determination of the forecast indices composition non-trivial. The "cross-section" of the entire technological chain of energy conversion in relation to which a forecast for energy demand would be feasible is particularly essential.

We believe that this "cross-section" is determined largely by the goals associated with the optimization of the energy sector by the degree of concreteness of the decisions made, and, naturally, by the available information. Hence, there can be at least three essentially different approaches to energy sector optimization, each having its own appropriate requirements for the content of the energy forecast.

1) Since the composition and cost of primary energy sources exert influence on the fields of application of finite energy sources, a full-fledged optimization of the power economy predetermines the forecast of energy demand at the level of its final utilization in the sphere of material production and for everyday amenities. Then, the requirements for energy sources, and all the more for primary energy sources, can be determined by optimizing technological decisions throughout the entire chain of power conversion, ranging from primary sources up to and including the final utilization.¹

2) In practice, however, it is common to have a more specific statement of the problem associated with the energy sector optimization, particularly when a forecast of demand for energy sources serves as a starting point of the calculations. In such a case the choice of rational kinds of energy sources for particular needs (or for final utilization) is beyond the scope of the optimization of the fuel and power system; the task of the optimization is reduced to the selection of the most optimal sizes of fuel generation plants and of the methods used in fuel production, processing, and geographical distribution. Production and

¹According to terminology in the Soviet Union final utilization is taken to mean those directions in power consumption which reflect the character of its final purposeful processes, e.g. power, thermal energy, lighting, electrochemical uses, etc. An energy source is the source of energy used directly in production, transport and domestic life to generate final energy; a primary energy source is the source of energy that formed as a result of geological development of the earth or other natural processes. See Energeticheskii Balans Terminologiya, in Russian (Nauka Publishers, Moscow, 1973).

geographical distribution of energy sources are included in the task too.

3) Lastly, in the most trivial case energy forecast may mean a direct demand for primary power sources. In this case, optimization includes only the allocation of primary power source production and distribution.

Centralized planning of the energy sector in the Soviet Union is exercised with a procedure that is intermediate between the first and the second statements of the optimization problem. The demand for energy sources is the value which is subject to direct forecast, and is therefore exogenous to the optimization, as is the rational composition of such sources for the most common technological and social processes. The great stability of forms of final energy expenditures in relation to the existing variety of technologies and the stable composition of energy sources for the greater part of energy consumption make it possible to draw up short- and medium-term forecasts of demands for specific energy sources with a simultaneous verification of the feasibility of their utilization in controversial cases. We believe that such an approach to the forecast at the level of energy sources under centralized planning is the most rational one, since it ensures a solution of practically all the tasks involved in energy sector optimization and requires much more readily accessible information than in the case of forecasting a final energy demand.

At the same time, the final energy expenditure in major sectors of the economy appears to be the best forecast parameter for a long-term perspective that is beyond the planning period. The correlation between the expenditures on final energy sources and the growth of the physical volume of production is more stable in time than the correlation between demand for physical energy sources and the physical value of production; the reason is that the energy conversion

in final energy consuming plants does not take place with a varying conversion coefficient. This makes it possible to specify more precisely the overall demand for final energy regardless of energy sources providing it; this final energy becomes then the basis for transition to individual sources of energy as applied to economic conditions of a long-term perspective.

When a composition of forecast parameters has been selected (i.e. of the "cross-section" of the technological chain of energy conversion), the method of forecast used acquires a decisive importance for the reliability and labor expenditure of the forecast.

At present, one can obviously speak of two fundamentally different approaches to the quantitative assessment of energy consumption. The first one consists in extrapolating the existing growth trends and the relationships between energy sources expenditure and such macroeconomic indicators of the national economy development as national income, gross (net) industrial output or physical (natural) growth indicators of a group of key industries, etc. A change in the field of application of energy sources is indirectly taken into account in this approach by introducing "elasticity" functions characterizing the degree of the interchangeability of various kinds of energy or fuel depending on their costs.

The second approach, making use of the advantages of a planned economy, envisages a determination of the demand for energy sources not by extrapolating the past but on the basis of existing plans of future development of various branches of national economy and on the basis of the overall analysis of technological processes. By using existing plans and technological analysis it is possible to form the most representative norms of energy consumption. With such an approach, the determination of energy demand ceases to be a forecast in the narrow sense of the word, and turns into a

system of calculations (including both calculations dealing with optimization and calculations with elements of heuristic decisions) reflecting external ties of the power economy with all other energy consuming industries.

The sphere of application of each of these principles of quantifying energy demand is a function of the interaction in time of the following three factors: 1) the rate of accumulation of structural and technological changes in the sphere of material production, 2) the possibility of obtaining sufficiently reliable detailed information about the power consumers, and 3) the accuracy required for the quantitative assessment of power consumption.

The totality of all the above conditions permits the extrapolation approach to be used in assessing energy demand either for the near future when a paucity of new structural and technological changes makes the use of labor-consuming calculation method unpractical, or for a rather remote future when the calculation method cannot be used any longer because of the absence of planning information.

From the point of view of reliability of energy demand assessment, the feasibility of employing the calculation method during the planned period proper is beyond doubt. Relying directly on the planned output of various kinds of products and services and providing for a detailed analysis of existing and new processes, this method makes it possible to rule out the major drawback of the extrapolation approach associated with insufficient consideration of inevitable changes, the drawback that has been revealed on the basis of the past history of the phenomenon being forecast.

However, a greater reliability of the forecast can be attained in this case by a considerable expansion of the information used and, hence, by making the calculation far more laborious. Indeed, the calculation method requires that

there should be a long-term economic development plan or, at least, draft versions of a plan. The possibility of obtaining such information virtually predetermines the sphere of applicability of this method. Obviously, it is infeasible to carry out such work for the sake of forecasting energy consumption alone; therefore the calculation method appears to be practical only in countries with a planned economy. In addition, a correct choice of energy sources requires a great amount of information about possible methods of energy supply for production and public services in various branches of the national economy, information which is again available only under centralized planning.

Taking into account the advantages and disadvantages of these two methods, a new hybrid method has been worked out in the USSR. It is based on the calculation method for determining most of the energy demand, while the rest, the so-called non-normalized part, is forecast in accordance with the extrapolation principle.

In implementing this hybrid approach, the greatest methodological difficulties were associated with establishing a rational correlation between calculation and extrapolation procedures. In practical terms it meant the selection of such a composition of branches and products for which energy demand can be determined most efficiently according to the norms of energy source expenditure, that is by multiplying planned output of production by these norms.

The essence of this operation consists in selecting the most energy-intensive products or the most representative types of products passing in the course of their manufacture through numerous, quite concrete stages of intermediate products. From a formal point of view, a compromise has to be sought between the desire to minimize the number of products under consideration and the wish to determine with their help the largest possible portion of the total energy output required by the national economy. In this case, of

course, the well-known fact has to be taken into account that in arranging the products by their energy intensiveness (with due regard for their representativeness), the increase in the number of products considered entails a progressively decreasing increment in the "normalized" power consumption. In other words, due to the widening of the number of products under consideration, the efforts toward collecting and processing additional information result in an increasingly less precise refinement of energy demand. For many years experiments on calculating power consumption for various combinations of industries and products have been conducted in the USSR, which made it possible to reveal their optimum composition (see Supplement). At the same time, we had to solve a rather non-trivial problem concerned with the selection of indices to measure the physical volume of production of various industries manufacturing diversified products on a large scale as well as problems concerned with the reliability and representativeness of the norms for energy source expenditure.

Based on the above indices, all the sectors of the national economy may be grouped more or less by conventional means as follows:

- industries manufacturing "multitonnage" production represented by a limited variety of items: ferrous and non-ferrous metal industry, production and processing of oil, coal and gas, production of construction materials;
- industries with varied but comparatively stable nomenclature of output and of its production technology: light industry and the food industry;
- and industries with varied and frequently changing nomenclature of output and dynamic production technology, which is especially peculiar to chemical industry, mechanical engineering and metal-working.

Other sectors of the economy, such as communal services, agriculture and transport can be attached from this point of view to the first group.

In the first group of industries, the production volume indices are individual kinds of products in their material form. A relative stability of nomenclature and production technology in the second group makes it possible to use gross output as a physical volume index. In the third group the use of gross output for these purposes is inadmissible because it can lead to serious errors in the quantitative evaluation of the demand for energy sources. For this reason, in determining the demand for energy sources in the chemical industry, one should strive for the fullest possible inclusion of output. For this purpose the twelve to fifteen most power-consuming and heavy goods accounting for about 60% of the total expenditure of electricity and heat in industry have been used in the USSR as such indices. Further increase of the share of the "normalized" expenditure can be ensured only by a sharp expansion of the number of included products, an expansion which is hard to realize.

A great variety of items used in mechanical engineering and metal working makes the application of the calculation method virtually impossible. The experience in using gross output as an indicator of the growth of the physical volume of production has demonstrated complete groundlessness of applying this indicator for long-term forecasts; cost of products fails to reveal both the structural shifts occurring within mechanical engineering and certain corollaries of the scientific and technological progress, for example reduction in consumption of materials and its energy consequences. The way out of this situation appears to be associated with accepting the instruments and objects of labor (types of inputs) as the indicator rather than the results of labor (types of output); the demand for electric energy can be estimated on the basis of individual power-consuming processes.

This makes it possible to get hold of the main link in the "production-technology-instruments and objects of labor" chain and to take account of the interaction among these components as fully as possible.

The above considerations and the calculation practice in the planning and research organizations of the USSR have made it possible to design a satisfactory information model to determine the demand for final energy sources and the overall demand for primary energy resources. Table 1 shows that the calculation method using this model permits us to determine up to 80% of the energy and heat demand and up to 90% of the fuel demand. In essence, this information model provides for the following.

To calculate the amount of electric energy used by industry, forty types of products in material form are used (see Table 1). Power consumption in light industry and the food industry is calculated by gross output, and in mechanical engineering and metal working in the following way: for power supply purposes, by the stock of machine tools for thermal treatment purposes and by the metal subjected to all kinds of thermal treatment (including smelting and heating). For mechanical engineering as a whole the "direct count" method permits determination of 70% of the overall expenditure of electric power in this branch of the national economy.

In other branches of the national economy (transport, communal services, agriculture) demand for electric power is determined for fields of utilization or processes as given in the Supplement, and this practically rules out any significant non-normalized expenditure of electric power.

To calculate the amount of thermal energy an industry needs, twenty types of products in material form are used (see Table 1). For industry as a whole the "direct count" method can calculate up to 65% of the total thermal energy consumed in this branch of the national economy.

Table 1. Share of the normalized expenditure of major energy sources in their overall expenditure.

| Branches of industry and national economy | When specifying demand for: | | | | | |
|---|---|-----------------------------------|---|-----------------------------------|---|-----------------------------------|
| | electric power | | steam and hot water | | fuel directly for the finite consumer plants | |
| | number of types of products, works and services | share of normalized expenditure % | number of types of products, works and services | share of normalized expenditure % | number of types of products, works and services | share of normalized expenditure % |
| A. Industry: | 44 | 70 | 24 | 45-65 | 30 | 85 |
| Fuel | 3 | 95 | 3 | 80 | 1 | 99 |
| Ferrous metallurgy | 10 | 70 | 6 | 42 | 10 | 99 |
| Non-ferrous metallurgy | 8 | 80 | 4 | 33 | 7 | 90 |
| Chemistry | 10 | 55 | 8 | 55 | 4 | 95 |
| Pulp and paper | 4 | 40 | 3 | 45 | - | - |
| Construction materials | 2 | 60 | 1 | 55 | 4 | 90 |
| Mechanical engineering | 1), 2) | 80 | 3) | 99 | 2) | 95 |
| Light | Gross output | 100 | Gross output | 100 | - | - |
| Food | Gross output | 100 | Gross output | 100 | 5 | 75 |
| B. Transport: | Work of transport | 88 | - | - | Work of transport | 95 |
| C. Daily life and communal services | 7 | 100 | 7 | 100 | 4 | 100 |
| D. Agriculture | 11 | 100 | 11 | 100 | 5 | 90 |
| Total for the national economy | 62 | 80 | 42 | 78 | 45 | 90 |

1) Demand for energy--seven types of equipment.

2) Volume of metal subjected to all forms of thermal treatment.

3) Cubic capacity of production buildings.

Demand for thermal energy in everyday life and communal services and agriculture is determined for the various fields of its application as specified in the Supplement. The heat expenditure for heating and ventilation purposes in housing and communal services is calculated on the basis of per capita rates of floor space, and the heat engineering characteristics of buildings in regard to calculated temperatures in various parts of the country. Heat expenditure for water heating is calculated proceeding from the planned range of the service to be rendered to the population.

In agriculture, just as in the previous case, the demand for heat is calculated for the areas specified in the Supplement. For each kind of work, there exist norms of expenditure of thermal energy per unit of production or per animal.

The demand for fuel consumed directly in final consumer plants is comprised of the following uses: in industrial furnaces and technological installations; in small thermal plants for heating and production needs of everyday services as well as for agricultural production in other branches of the national economy; in mobile (all kinds of transport) and stationary power plants; and itself as a raw material.

On the whole, the field of direct burning of fuel in the course of material production and in communal services is substantially narrower than that of other energy sources, particularly electric power. This substantially facilitates the calculation of fuel demand and all other conditions being equal, increases the share of the normalized portion.

Thus, in industry about thirty types of products mentioned in the Supplement determine up to 78% of the total expenditure of fuel used directly in furnaces and other technological installations. The share of normalized

expenditures is still larger for other fields of fuel use which are strictly purpose-oriented by their nature. Calculations have shown that in this case the share of the normalized expenditures of fuel is no less than 86% of the total fuel expenditure in the national economy of the USSR.

From this it follows that the composition of the products and services given in the Supplement is representative enough to determine, with the help of the calculation method, a rather large proportion of the overall demand for energy sources. If we will take into consideration that the total fuel expenditure for the production of electric power, steam and hot water is also normalized, then the total share of the normalized part of overall demand for fuel and energy resources (without exports) may be raised to 80%.

Selection of representative indices showing the development of various sectors of national economy is but one of the ways of attaining a greater accuracy in the calculation method for determining energy demand. A second way is based on a forecast of norms of energy source expenditure. The direct dependence on the kind of energy source and the norm of its expenditure on the technology used in manufacturing a particular product make it necessary to take into account such factors as unit power of the equipment, quality of initial raw materials, climatic characteristics of the region where an energy source is located, etc. In doing so constant care should be taken to assure the correspondence of the kind of energy source to be used in future production conditions to expected expenditures for its provision. This is one of the most responsible aspects in the energy demand forecast regardless of the methods used for its quantitative assessment.

In a number of cases the choice of the kind of fuel or energy for final consumer plants is accompanied by a comparison of corresponding energy methods, of power supply, for instance, in the case of heat supply to the population, agricultural production, heating of metal in mechanical engineering, etc. In these cases optimization of energy sources merges with optimization of power supply, systems of transport and distribution of energy and fuel.

Of fundamental importance is the fact that the above system of interconnected calculations is characterized by a strong feedback. It manifests itself in selecting energy sources (when the user's economic effect obtained by utilizing a specific energy source is compared with the costs incurred in providing these energy sources), in selecting energy supply plans and the parameters of power equipment and in determining the economically justified volume of secondary energy sources to be used (in the process of comparing the damage caused by excessive fuel consumption with the expenditure for power plants and energy distribution). Optimum solutions in all these and similar particular energy problems can be ensured by using shadow prices² of fuel and energy when assessing the energy component in comparable

²Shadow prices of fuel, electric and thermal energy are a system of interacted specific economic indices characterizing economic assessment of the expenditure for the national economy to provide for additional demand for various kinds of fuel and energy in various regions of the country. Shadow prices are formed with due account for the differential rent characterizing the difference of the geological and mining conditions of output, location and quality of fuel (Rukovodyashchie Ukazania K Ispolzovaniyu Zamykayushchikh Zatrata na Toplivo I Elektricheskuyu Energiyu, in Russian (Moscow, Nauka Publishers, 1973)).

versions. As a result, the identified absolute scale of demand for individual energy sources is optimal for a given technological structure of the material production, works and services corresponding well enough to future conditions of the development of the energy sector as a whole.

The long experience the USSR has accumulated in the use of the above methods to calculate energy demand has made it possible to improve them substantially from a technical point of view and to turn them into an adequate instrument for determining power consumption in a planned economy.

Supplement

Below is a list of major output items and services for which a demand for energy source is determined by the "direct count" method.³

Ferrous Metallurgy:

pig iron, coke, open-hearth steel, converter steel, electric steel, rolled steel, pipes, sinter, ingots, iron ore output, oxygen production.

Non-ferrous Metallurgy:

alumina, aluminium, copper nickel,* electrolytic nickel, magnesium, titanium, blister copper,* refined copper, copper ore output, lead and zinc ore output, lead, zinc.

Chemical Industry:

ammonia, plastics and resins, methanol, caustic soda, soda ash, artificial fibres, calcium carbide, yellow phosphorus, sulphuric acid, artificial rubber, apatite concentrate.

Pulp and Paper Industry:

paper, pulp, board, wood pulp.

Fuel Industry:

petroleum production, oil refining, transportation of oil in pipelines, coal mining, gas extraction, transportation of gas in gas pipelines.

³An economic substantiation of the energy sources is required for the asterisked types of products and services.

Construction Materials Industry:

cement, ferro-concrete structures, red brick,
window glass.

Light Industry:

gross output.

Food Industry:

gross output.

Mechanical Engineering:*

production of forged and stamped pieces, pig iron
casting, steel casting, non-ferrous metal casting, thermal
treatment after machining and casting.

Work of Transport:

railway,* river, sea, air and automobile transport.

Communal Services:

lighting, television, radio and the whole range of
small household appliances, cooking,* hot water production,*
heating and ventilation.*

Agriculture:*

for the upkeep (lighting, heating, preparation of
fodder, etc.) of cattle (beef and dairy), of pigs, poultry,
other animals, heating of hotbeds and green houses, drying
and processing of grain, production of vitaminic meal,
irrigation, for field work.

Some Problems of Energy Demand in Poland

J. Filipowicz and A. Kłos

Energy demand in Poland is growing systematically according to the industrial and social development of the country. The growth of energy demand and its structure is shown in Table 1 below. An analysis of the table can be summarized as follows:

- According to its natural resources, Poland is a country of hard coal. In 1970, hard coal provided 74% of the national energy production and in 2000 it will provide about 41%. It should be noted both that these figures differ substantially from the averages in other European countries, and that Poland exports a great deal of hard coal.

- The global energy demand is growing rapidly; during the thirty year period 1970-2000 it will increase about four times.

- The electrical energy demand is growing most rapidly; during the thirty year period 1970-2000 it will increase about nine times and its percentage in the national energy demand will rise to 18%.

- The centralized heat supply in Poland (hot water and steam) is comparatively very high. In 1970 its percentage in Poland's energy demand was 22%, and it will drop to 17% in the years 1990-2000.

- Energy production in nuclear power stations is rather low.

The number one problem for us is the forecast of energy demand in long range terms. The figures presented in Table 1 are one of the possible variants of energy demand up to the year 2000. The estimate is based on the assumption that the gross national product will grow 6.5 times by the year 2000, and that the population will grow 17% during the same period. Some other assumptions concerning the above two factors are of great importance for the final figures. The above energy

Table 1. Energy balance in Poland¹⁾ in million tonnes coal equivalent (tce).²⁾

| | 1950 | 1960 | 1970 | 1980 | 1990 | 2000 |
|------------------------------------|------|------|-------|-------|-------|------|
| 1. Energy Demand primary | 49.3 | 77.0 | 119.4 | 200 | 324 | 462 |
| 1.1 hard coal | 39.9 | 69.1 | 88.4 | 121.3 | 148.0 | 202 |
| 1.2 lignite | 0.3 | 1.2 | 8.8 | 9.7 | 18.5 | 18.5 |
| 1.3 oil | 0.9 | 3.2 | 12.1 | 48.9 | 94.0 | 124 |
| 1.4 gas | 0.3 | 1.0 | 7.1 | 16.7 | 47.0 | 62 |
| 1.5 hydro | 0.3 | 0.3 | 0.8 | 1.0 | 1.5 | 2.5 |
| 1.6 nuclear | - | - | - | - | 13.0 | 51 |
| 1.7 others | 2.2 | 2.2 | 2.2 | 2.4 | 2.0 | 2 |
| 2. Conversion and Transport Losses | 9.9 | | 27.2 | | | 116 |
| 3. Energy Demand: Secondary | 34 | | 91.2 | | | 346 |
| 3.1 electricity | 1 | | 6.7 | | | 61 |
| 3.2 hot water and steam | 6 | | 20.3 | | | 60 |
| 3.3 gas | 3.5 | | 9.5 | | | 67 |
| natural | | | (4.7) | | | (45) |
| industrial | | | (4.7) | | | (20) |
| liquid | | | (0.1) | | | (2) |
| 3.4 oil products | 0.5 | | 8.0 | | | 80 |
| 3.5 coal | 18 | | 34.1 | | | 33 |
| 3.6 coke | 4 | | 10.9 | | | 40 |
| 3.7 others | 1 | | 1.8 | | | 5 |

1) K. Kopecki, Polska 2000 (Warsaw, Ossolineum, 1973).

2) The tce = $7 \cdot 10^6$ kcal = $29,302 \cdot 10^9$ J.

demand projection was made in 1973. Now a new projection is being made in order to establish the current versions of energy demand growth by taking into account the new situation in the energy market.

In the new projection the figures for energy demand are about 10% to 20% lower than those given in Table 1. A steeper reduction of the energy demand could lead to the reduction of the gross national product and it is not considered. More essential changes are foreseen as far as the structure of the energy mix is concerned. In order to solve the problem and to find the optimal strategy of the energy supply, many research studies have to be done. An entirely new situation and the end of the "period of cheap energy" make the energy problem difficult to solve.

In order to improve the energy balance the following are proposed:

- Coal production, (hard and lignite) should be expanded as much as possible. The growth of the coal mining industry is very much limited by the lack of labor force and by environmental limits. Doubling of the coal production is the most could be done up to the end of the century;
- Energy production in nuclear power stations should balance the energy demand. There are, however, certain limits which prevent the development of nuclear energy production;
- Energy and fuel consumption should be rationalized and optimized by:
 - 1) new technologies in industry which are less energy consuming;
 - 2) utilization of the heat wasted in technological processes especially in steel, iron and other

metal production, the chemical industry and so on;

- 3) reduction of heat losses in all kinds of buildings by improving the thermal insulation and by regulation and recuperation of the heat in buildings;
- 4) new energy conserving means of transportation of goods and the reduction of transportation needs by rational localization of factories;
- 5) reduction of losses in energy and fuel production transformation and utilization processes.

The methodology of the energy demand projection should be given greatest concern. In medium and long range prognosis all direct methods like correlation and extrapolation are virtually useless unless they are not just statistical extrapolations of the past into the future.

The medium and long range prognosis can be improved by using the so-called heuristic extrapolation, the essential features of which are taking into account and investigating some important matters influencing the process considered. Considering the nature of the process and taking into account the expected social and economic development of the country, and taking into account the international situation, one can predict the shape of the projected function for such things as is it linear or nonlinear, convex or concave, monotonic continuous, has it extreme points, etc.?

There are many factors which can have an essential impact on the shape of the function to be predicted. They can influence very much the parameters in the statistical functional relations. The main factors are:

- the evolution of the structure of the global national product;
- the limitations in the growth of the global national product;
- the evolution of the distribution of national income;
- the evolution of energy consumption per capita;
- the changes in price relations of the main fuels;
- environmental limitations;
- general progress, politics, social relations, etc.

The new tendencies can be revealed by the analysis of the derivatives of the statistical trend. First, second and third derivatives are used to describe the process and to investigate the changes and tendencies. Sensitivity analysis of the macroeconomical parameters such as global income, gross national product and others is of particular importance.

Special attention should be paid to the boundary values. Finding such values for an infinite time period permits the effective narrowing of the range of the prognosis in the finite future.

The next problem is the complex optimalization of various forms of energy utilization and production. Up to now, the energy systems such as electricity, gas, oil and coal are optimized independently of each other. Research work is under way in order to create the mathematical models and methods for the complex optimalization of an energy balance.

A very important problem, whose solution is under way, is the establishment of a data bank for energy problems. Such a bank provides a necessary tool for dealing effectively with problems.

Planning the Energy Demand for the German Democratic Republic

W. Hätscher

In the German Democratic Republic the most important means of production are owned by the people. This condition is a prerequisite for planning on a society-wide level, for all fields of economic and social development. As far as the energy industry is concerned, both the economy's and the population's energy demands have to be met to ensure the proportional development of all branches of society, on the one hand, and the planned increase in living standards on the other.

The interrelationship between the energy industry and the rest of the national economy is very close. In all fields, an ever growing energy demand has to be met; therefore, the energy industry has to use considerable amounts of social resources such as investment, manpower, etc. An ever growing energy demand also creates serious environmental problems.

These close interrelations and the fact that investment in the energy industry generally needs relatively long preparation, while investments are tied up over long periods of time, show that the energy industry is not only strongly dependent upon overall economic development but itself plays a crucial role in determining the development rate of the national economy. Therefore there is an urgent need for long-term planning in the energy industry. In planning several decades ahead account has to be taken of all the industry's interrelations, and the economic aspects of its structure have to be optimized.

Two stages are involved in energy industry planning:

- 1) planning of energy consumption (heat, power, light); and
- 2) planning procurement of energy resources and primary energy.

The long-term plan for the development of the national economy, which lays down among others indices for the growth of national income and of gross production, and for the accumulation-consumption ratio, serves as a basis for planning the amount of service energy needed, i.e. the demand for those energy resources which are destined for direct conversion into heat, power, light, etc. The development of individual branches and of product structures as well as the improvement of living standards are derived from the long-term plan. The planned scientific and technological development is another basic aspect determining the development of production techniques, composition of raw materials, and technological and economic indices of energy demand. These data are necessary conditions for defining the volume, the structure, and the chronological development of the amount of service energy needed.

Figures on service energy demand, plans for the scientific and technological improvement of methods and processes of energy generation, conversion and transportation, as well as detailed knowledge of maximum availability of energy resources are fundamental aspects in planning the procurement of energy resources and primary energy. More restrictions which play an important part in the planning of the energy industry are brought in by limits on capital expenditure and by environmental considerations. The necessary procurement of all energy resources, their timely development, and primary energy demand can be calculated with the help of technological and economic indices reflecting interrelations within the energy industry, and by taking into account all limiting factors.

Passing once through the two stages outlined above, however, does not mean having accomplished the planning for the energy industry. For two reasons these two stages have to be repeated several times in the short- and medium-term planning, and above all in long-term planning:

- a) The basic initial data of these two stages are not static but change in the process of planning. It has to be pointed out that planning in the energy industry does not start once the other sectors of national economy have brought their plans to a close. Just the opposite is true because since the energy industry needs forecasts over particularly long periods, it is bound to start often at a moment when the energy-consuming branches have only a very vague idea, if any, of their development. In the course of long-term planning energy planners are even frequently forced to bring forward their own hypotheses on the potential needs of certain branches; these hypotheses can subsequently be adjusted together with the planning experts of the branches in question.
- b) Outward dynamic factors are responsible for the repetition of energy planning stages. Of equal importance is the fact that the results of both stages have mutual influence. Calculations for energy resource supplies therefore may yield conclusions as to possible service energy supplies. This means that conclusions regarding the structure or even rate of development of the national economy have to be drawn from factors pertaining to the energy industry. An answer then has to be given, for instance, for the question of whether it would be good to envision certain additional importations of energy resources or would giving up the extension of some energy-intensive branch or process not be more useful for the national economy.

Quite a number of methods are used for long-term energy planning in the GDR. Economic-mathematical models which were first developed more than ten years ago and which since have been introduced gradually into practical planning are the central parts of these methods. They constitute in fact a system of synchronized linear medium-term optimization models. The

objective function is to minimize the overall social labor expenditure (labor costs, material costs, capital costs, etc., discounted at the appropriate rate) in order to fulfill a given task in production or supply over a given period of time. Social labor expenditure includes all current and unique expenses from the time of their occurrence, including procurement for extended reproduction and social consumption. The objective function was developed under the guidance of national economy planning, and it is to optimize not only the structure of the energy industry as an individual branch of industry, but also the energy industry's integration into the national economy. As pointed out at the beginning of this paper, the maximum economic benefit for the whole of society and not for an isolated branch or enterprise is the optimality criterion.

The demand optimization and the production optimization models are the fundamental parts of the Central Model System for long-term energy industry planning. For the time being, both are laid out to cover the period between now and 1990. These and other models can be coupled since they have identical mathematical structures (linear programming), objective functions and time differentiations and use the same kind of energy resource nomenclature.

The demand optimization model determines the demand for service energy. The production optimization model allows the structure of energy generation and conversion plants, the production of all energy resources and primary energy to be calculated. The demand optimization model selects optimum variants for those energy consuming processes which allow different techniques involving different energy resources to be applied. It determines, for instance, whether cement should best be manufactured using the wet, the Lepol or the dry processes, and with pit coal, fuel oil, natural gas or powdered brown coal. The remaining energy demand which cannot be substituted for and is not worth while optimizing is simply shown in the balance

sheet.

The production optimization model includes all essential facilities of the coal, power, and gas industries, of primary oil processing and heat generation irrespective of what administrative body they report to. Service energy and restrictions imposed by the national economy determine not only the volume of the production of energy resources but also the specific social expenditure needed for making each of the energy resources available. Specific expenditure is taken account of in optimization calculations with the demand optimization model and thus influences service energy structure. This in turn requires calculations with the production optimization model. Iterative calculation is continued up to a predetermined degree of consistency between demand and supply potentialities.

Apart from the two above-mentioned models, other models are being used to optimize territorial energy structures and power plants within different sectors of the energy industry (such as coal and crude oil processing, power generation and other industries). These models can also be coupled with each other and with the models mentioned above.

After setting up the long-term energy balance with the help of optimization models, check computations are made with global methods. Furthermore, economic consequences resulting from the balances are determined (such as the demand for investment funds, demand for foreign currency for energy resources importation, demand for manpower, jobs to be done by the building industry and energy plant manufacturers, etc.). If the balancing on the national economy level shows that the variants thus found for the development of energy industry cannot be synchronized with the planned development of the national economy, calculations have to be repeated. If the variant is acceptable from the point of view of the national economy, it is incorporated into the corresponding state plans, in particular into the five-year plan. These plans have legal force,

thus ensuring that the socialist state implements a structural development found to be optimal for energy industry.

Finally, note the part played by energy prices in planning the GDR's energy industry. Only prices for imported energy resources exercise an influence on the structure of the energy industry. Actual transaction prices paid for any of the domestic energy resources have no influence whatsoever on energy balance optimization.

The actual social expenses are the only determining economic factor in optimization. If it is true that in principle actual prices reflect social expenditure, they are not always identical with it. Fixed fuel prices have, however, an important role to play in implementing the long-term energy plan. They are differentiated in such a way that enterprises are stimulated to back the government's energy policy and to implement it in their fields of action.

DiscussionHutber

It is misleading to think of trend extrapolation as being simple. I agree that there are simple ways of looking at trend extrapolation, but I believe that underlying the idea of trend extrapolation is the belief that we are talking about a behavioral model, one which is determined by the consumers themselves, their aspirations for what they want to do, and these are things not readily controlled by econometrics. Before we dismiss extrapolation completely I would like to say that we do use a form of extrapolation, but it is very complex and it is rather more akin to a behavioral model than simple extrapolation. The other observation I think applies to both the Kjos paper and the Vigdorichik-Makarov paper.

I would like to draw attention to the fact that the apparent gap between the controlled economies and the state which the Western world is in on the energy situation is not as different as one might be led to believe. We have just been informed that the environment of forecasting in Russia is one in which the economic pattern for a number of years to come is firmly fixed by a set of optimization decisions. The optimization process is one by which you just allocate your energy resources to maximize some objective function, presumably minimum cost. This is very similar to Western economies when you consider that, apart from the fact that we do not set about and decide what our economic parameters are going to be for the next five years, we do say what we think they are going to be and having committed ourselves to that thought we then try to balance our industries in the same sort of allocation by way of moving across the boundaries of the individual industries. The industries are not independent elements in the market economy; they are becoming more controlled and with an energy policy as such, whether it

is a national one or supernational one, we are getting very much closer to the allocation problem which has been described in the earlier paper.

KYos

I agree with Hutber's comment that it is misleading to think of trend extrapolation as being simple. He is proposing the extrapolation method called "UASTIC," which he considers not entirely useless. I further agree with Hutber's statement on the resemblances of Eastern and Western economies, in the matter of setting targets for energy demand (by industries).

Albegov

In one of the diagrams you showed us the growth of demand for coal in Poland by 50% from eighty-eight million tce to 121 million tce and growth of demand for oil by four times from twelve million tce to forty-eight million tce. Is this decision the result of optimization in view of the rapid growth of the cost of oil? It can be a very expensive balance.

KYos

The figures for 1980 and 1990 are not obtained from an optimization procedure. They come rather from the balance of fuels and from the production possibilities of coal and lignite. We are very short of gas and oil in Poland.

Mount

I am not too certain that I have understood what Hutber said about econometrics. I do not feel that econometricians have much influence in the US for planning electricity capacity. Expansions are traditionally planned using engineering procedures. I think what is interesting is that econometricians come up with very different answers. Since the traditional methods being used by the utility companies do not look so good, maybe they will change in the future.

Parikh

I do not think one should really worry about the dichotomy between the engineering approach and the econometric approach because it seems to me that there is a clear cut place for both approaches and one has to have an integrated view about this. For example, I think it makes a lot of sense to have a programming type of approach when you are talking about energy as a derived or intermediate demand. However, when energy is used in domestic sectors and others where people's preferences have to be respected, then any kind of control techniques that you want to use have to bring in prices and preferences, and you have some kind of econometric estimates of demand as a function of price. I think if one can have a combination of these two efforts for one set of sectors using the programming approach and for the other set of sectors using the econometric approach, that would probably optimize the system.

Woite

I would like to ask a question with respect to the planning procedure which has been described by Belostotski and which seemed to be very elaborate and sophisticated. Are contingency factors foreseen in this planning to cover demand which cannot be foreseen at the time being? When you assess the demand for certain products, the demand might increase with time or it might saturate.

Belostotski

I should say that your question relates to the problem of planning in circumstances of uncertainty. I did not say anything about it, but we do some work in this area. Moreover, our planning process is a process which might be repeated in one or three or five years and during this process we try to adjust our plans with the new information.

Foell

We are carrying out a regional energy research program here at IIASA in which we are working with three regions of the world and trying to integrate some supply, demand, and environmental conditions. I may have missed it in your paper, but I am wondering whether you discussed the question of regional optima versus national and global optima and how you handle the question of planning for regional optima and national optima.

Belostotski

We calculate this optimum in one mathematical model which has several regions, about thirty to forty, and more for the short term. I was personally working with the model that had eleven regions, eleven points, and showed some optimal distribution of energy resources toward the demand in these regions.

Foell

What sort of formal methodology did you use?

Belostotski

Linear programming methods.

Nordhaus

I would like to make a few comments on the papers concerning the Soviet Union and Poland. There is important material here to study on both parts and let me say why. We have seen in the papers this morning relative emphasis on econometric techniques which are almost purely behavioral and have very little in the way of technological constraints imposed. And we have seen almost the exact opposite this afternoon in the discussion where most of the emphasis is upon the technological and input-output relations, and relatively little emphasis on the behavioral aspects, in particular perhaps on the response of consumers. I think that in particular for some of the work that has gone on in North America that we really should think hard about whether

we want to push harder into introducing some of the technological constraints instead of black box or behavioral constraints, in particular on the problems we talked about this morning of interfuel substitution and the plague that has been on econometricians. I think we should seriously consider whether a completely different approach from the one we have been using would be able to cut through this difficulty.

I would also like to mention something on the use of shadow prices and especially with reference to what Hutber has said. There is a fundamental difference between the techniques used in the East and the West. The West does not rely upon the use of shadow price techniques. There is no reason that the shadow price used in the West in different industries and different firms should be the same. It is a fundamental point in the kind of optimization techniques that we discussed here that the shadow prices used in all industries should be the same. In the West we have not had much use of shadow prices. The use has been pioneered in the Soviet Union following the work of Kantorovich. I understand it has been used very widely in the energy sector especially. I think here again in the absence of futures markets in market economies we should think very seriously about the question of whether shadow prices should be used as substitutes for the nonexistent markets.

Hutber

I would like to object if I may, to associating all Western countries with not using shadow prices. We certainly do use shadow prices in the UK energy sector and I would not want to be associated with not using them. Also I would like to make it perfectly clear that certainly as far as the UK is concerned we do not look at fuels in isolation. Our work is done in an integrated fashion with all the fuels being considered. In fact, the main process that we use is to forecast total energy by sector. It is only at a later stage that we break it down into the individual fuel components.

Belostotski

I must add to Nordhaus' comments that there are two main points which must be mentioned in our discussion now. First, that the planning process in our country includes a simultaneous process for all branches of the economy and second, that we have the effect of the energy branch not through a market but through the process of planning. This is simultaneous for all branches. This process is part of our methodology.

Parikh

May I ask a supplementary question. What do you do if the shadow prices are not stable?

Albegov

I refer to a report prepared in another section of IIASA. We think that the system of these shadow prices depends on the rate of initial expenditure in our large coal basins such as the Donets and the Kuznetsk and we have in these basins an additional capability for meeting all additional demand, and this enables us to use stable shadow prices at the lower levels.

Styrikovich

My opinion is that today in the market economy countries many big decisions are governmental and are planned. In the last few years in our country many governmental decisions and many data for the "optimization model" have derived from the statistical extrapolation of the aggregated needs of individual consumer goods and we rely in some sense on the market or the demand and supply of these goods. We have institutes working on the problem of the future trends of the people's demands. These institutes are connected with the Ministry of Domestic and Foreign Trade.

But the major part of our energy demand derives from direct calculations of fuel requirements after levels of production are planned for large enterprises or planned levels of steel

production, electricity production, etc. As Belostotski added, we have permanent planning machinery which means that, with some new factors coming up in the planning review, we can include them in the model for reoptimization, taking into account all the possibilities that we have for balance of investment, balance of payment, balance of labor forces, etc.

Hutber

Could you give us some rough idea how many institutes are involved in this planning process?

Styrikovich

In the process of planning we have many institutes. But for the process of optimizing the energy balance itself we have today I think five or six big institutes. The major part of their work is in the optimization of energy demand and supply and energy balance optimizing. I think there are about 500, maybe 700, scientists devoted primarily to this task in specialized, scientific institutes working for the Ministry and Central Planning Committee of the Soviet Union, Planning Committees of the Republics and other administrative bodies. The total number of people engaged in energy planning at central, republic, and local government levels is even higher. But the figure of 500 to 700 relates only to the specialized scientific institutes. These date, I think, from 1958 and 1959 when the system of the so-called shadow or closing price was established for energy balance optimization.

A small remark for Parikh: Of course shadow prices based on the cost of production and distribution are variable and change with time, but I think that the shadow price based on the cost of production and distribution is more stable than normal market prices.

Khazzoom

You have been using the term "energy balance" and I want to make clear to myself that we are talking about the same thing. We had a paper this morning by Slesser on energy balance. Is that the term that you have in mind? Do you maximize energy balance in the same sense that he was talking about?

Nordhaus

He is asking about the objective function in your optimization.

Styrikovich

The objective function is the minimum cost to meet the planned needs. The minimum cost is called the calculating cost, and it includes all labor costs, material costs, and 12% per year for investment. The 12% is the present standard practice for such calculation in the Soviet Union. It is possible to change this in the future. It is interesting that if you change this percentage in the long-run it will affect the outcome. If this percent is too high, it means that all the enterprises will choose expensive investment with a consequent high demand for labor. If the rate is too low, the consequence is too much capital investment. In the first case you will have shortage of labor, in the second you have an excess of labor and a shortage of investment.

In principle this means that with a discount rate of 12%, we have full employment of capital and labor. Of course, it is not so simple in timing sometimes because the location of resources forces us to raise prices. For example, the price in central Siberia is low because energy is very cheap in this region. But we have a shortage of labor and this restricts the possibilities for new investment. Further, it means that we need bigger investments in the infrastructure of central Siberia, bigger investments of cultural and housing measures to make central Siberia attractive to people. All this needs time, and, because of this, sometimes it is necessary to revise the plan and to reoptimize our allocation of energy, labor, and investment, in short, our whole plan.

Woite

Just for clarification I would like to ask you if this 12% per year capital charge which you mentioned is in real terms or is there any inflation?

Albegov

The value of the product is taken as a constant over time for project calculation. [Therefore it is a real interest rate --Ed.]

Parikh

I would like to clarify my earlier question on the stability of shadow prices. I thought what was being said is that in order to take into account uncertainties that may arise in the future, the Soviet Union carries out the exercise with a higher and a lower estimate of demand. It seems to me that in both cases you look at the shadow prices and find that the shadow prices are stable. I ask, when you are doing this exercise, suppose you find that shadow prices are not stable, then what do you do? And secondly, regarding the point you made that shadow prices are more stable than market prices, I beg to differ. I find that in most linear programming exercises that I have seen the shadow prices fluctuate widely from year to year, and from period to period. It can happen, given an initial imbalance, that the shadow price is zero for a particular resource in one year, and next year you have that particular resource constraint binding and its shadow price can become very high. So in linear programming exercises I find that the shadow prices fluctuate very widely.

Styrikovich

They fluctuate widely only if some big change occurs. Because the external market is small in the Soviet Union, the influence of the external market on our economy is not important. Therefore, some technological changes, some changes from

discoveries of new resources, and some errors in planning will of course go into the changing of shadow prices, but for so big a country several errors in one area are mitigated by opposite errors in other areas and our practice shows that shadow prices in our country are very stable. There was one big change recently; because of the big changes in oil prices the usefulness of our oil and gas exports changed.

Belostotski

First a small addition to what Styrikovich said. I think that the stability of the shadow price depends upon our special circumstances. We have regions of coal which will be the stabilization factor in our formation of the shadow prices. If you must go from one basin to another basin, or from one region to another to meet your changeable demand, you have changeable shadow prices; but we have the great region of coal in Siberia and this coal region stabilizes our shadow prices and this meets the changeable demand. Second, as for the dependence upon the world market prices, I think that there are some strata in our energy balances. The world prices have a connection with only a small stratum of our demand.

Nordhaus

May I just comment on this, because I think in fact the sensitivity really depends on the time period of the estimate. In the short run where output is capacity constrained, you find that shadow prices are highly variable. In the long run where output is not at all capacity constrained, the cost curves are flat and you find the shadow prices tend to be very stable. My understanding is that the calculations that you are talking about for the Soviet Union are mainly for long-run planning purposes, and therefore it is reasonable that your shadow prices would be much more stable than those of Parikh, which are for the short run.

Styrikovich

Yes, it is mainly so because the changes of our shadow prices do not affect the price to the individual markets in the Soviet Union in the short run, and, as a rule, they also do not change the prices for the big governmental type of consumer. We change actual prices only gradually after a big change in the shadow price. Because of this, changes in the shadow price do not change the demand from our internal market, so we change actual prices only from time to time when the big differences in shadow prices accumulate.

Waverman

In practice, do you use the shadow price or the actual price in calculations, say for steel plants?

Styrikovich

Because all steel factories belong to the government, we use the price which is the highest price among the individual factories. If we have for example very low cost gas in the Ukraine, but limited supplies, the cost is not used as the shadow price. Shadow price is a price for closing the balance in energy resources. We have very cheap energy resources and of course at first we use the cheapest, afterward the more expensive, and finally the highest price as the shadow price. Of course this does not hold for existing plants. It is for new plants because for existing plants the capital investment is already in place; in many cases the real cost will be with the old investment. The output of this factory goes to the point where the cost reaches the shadow price.

Hutber

You have a dual pricing system internally, a planning price and an actual price.

3.2 Western Europe

The Influence of Prices on the
Consumption of Energy

P. Morin

Over the past ten or twenty years, the consumption of energy (aggregate or by sectors) of the different countries has been closely correlated with the evolution of their respective Gross National Products. In econometric studies, the price of energy or of its different forms does not constitute a significant explanatory factor. Indeed, the regularity of the evolution of the real price of energy (in constant decline) is not sufficiently informative.

On the other hand, it is to be noted that the level of the consumption of energy (expressed in tons coal equivalent (tce) per dollar of GNP, for example) varies considerably from one country to another, without the price of energy constituting a completely satisfactory explanatory factor either. The sudden rise in the price of imported crude oil after the end of the year 1973 has contributed to an appreciable modification in 1974 of the aggregate consumption of energy as well as in consumption after breakdown into its various forms.

The definition of new medium-term energy policies has given rise to many supply and demand forecast studies. If determination of supply curves can be the result of the aggregation of various technological and economic studies, definition of demand curves appears to be a far more delicate and uncertain matter. In this study, we shall strive to analyze the behavior of consumers (households and industries) who are faced, on the one hand, with high-priced energy, and, on the other hand, with modified relative prices for the different forms of energy.

1. Main Factors Acting Upon the Demand for Energy

The main factors acting upon the demand for energy are the gross national product and the incomes of households, the "guiding" price of energy, and the relative prices of the various forms of energy. Technological evolution must also be taken into account.

At a given moment, a variation in one of these parameters influences the choices made by consumers, modifying the volume and the distribution of energy consumption. It may be considered that for a given set of parameters an optimal situation corresponding to consumer equipment exists, and that the equipment is perfectly adapted to the determining variables.

In reality, this situation is never achieved. Energy-consuming equipment has a rather long life span, and the anticipations of consumers are uncertain. Each consumer is thus confronted at all times with the problem illustrated in Figure 1.

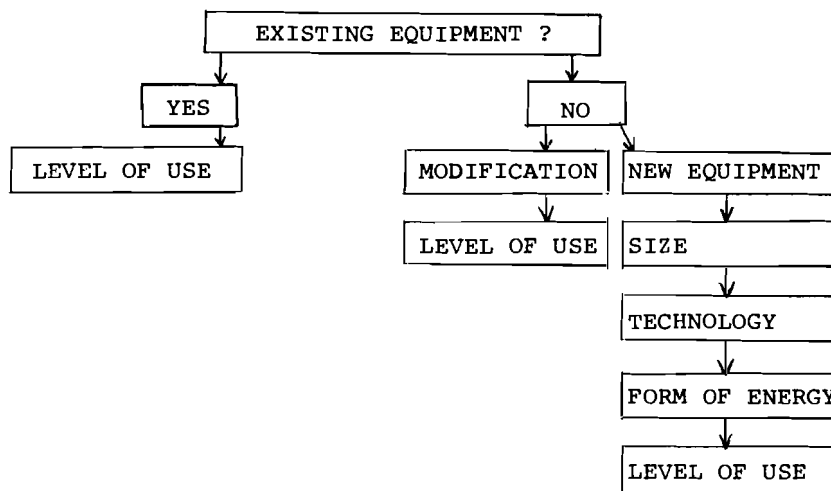

Figure 1. Choices open to consumers.

It must be noted that variations in the consumption of energy at times when prices vary little are mainly due to the acquisition of new energy-consuming equipment and the replacement of old appliances by more energy-intensive appliances. The effect of more intensive use of pre-existing equipment is a marginal factor. The evolution of consumption can then be explained by an increase in industrial production and an increase in the purchasing power of households.

The modification in the price of energy broadens the range of choice of the consumer, whose behavior varies depending upon whether the modification is a purely cyclical or a more durable phenomenon. In the first case, the decisions concerning equipment will for all practical purposes not be modified, but the level of use the consumer chooses will be different.

In the second case, the consumer will adapt his decisions on equipment to an anticipated price of energy which is more or less subjective. Under such conditions, the new equipment chosen will be different, and the overall renewal of consumer equipment will be hastened. The effect of a modification in the price will then increase as time passes, along with the share of adapted equipment owned by consumers. One may therefore distinguish between a short-term elasticity, resulting from a rigid equipment structure, and a medium-term flexibility, increasing with the adaptation of consumer equipment to the new price.

2. Substitutions Between Forms of Energy

Variations in the relative prices of the different forms of energy also modify the choices made by consumers. One can distinguish short-, medium-, and long-term effects. On a short-term basis, the level of consumption alone is modified, with no adaptation of equipment except possibly in the case of industrial consumers who possess a mixed power supply. On a medium-term basis, consumers will optimize the power supplies of their new equipment. Finally, on a long-term basis, technological innovations can broaden the range of substitutions.

In certain markets, term substitution is very difficult (e.g. automobile use, or aluminum production), while in most markets it is possible.

Analysis of the competition must take into account the economic cost of supplying energy. A specific technology of use corresponds to each form. The price of the energy itself corresponds to only part of the cost of supplying it to the user. This cost includes amortization and upkeep (storing, conversion, cleaning).

Thus, if a form of energy requires equipment that is less capital intensive in nature and offers a better quality of service (better yield, greater stability, easier regulation), equality of conditions of competition does not correspond to equality of price per thermal unit purchased by the user. This is of particular importance in the industrial markets where employment specifications may be variable.

3. Anticipations of the Economic Agents

The decisions of the economic agents do not hinge only on sure variables; they are also a function of their particular conception of the future. The forecasts or anticipations of the economic agents are rational only up to a certain point. Thus, an enterprise's choice of investments can give rise to economic calculations, but the decisions of households are marked by far greater subjectivity. When one observes a regular evolution over a long period, the problem of a collectively conscious evolution practically never comes up. Thus, in the sixties, the continuation of past evolution constituted the best possible forecast until 1972, and optimal decisions were repetitions of previous choices.

Conversely, the durable nature of the sudden reversal of the trend which occurred in 1973 can be interpreted in different ways. Whereas the experts can furnish only very uncertain forecasts, economic agents can take extremely varied decisions,

owing to the possibilities of varied forecasts and choice criteria in uncertain futures. Under such conditions, the desire to define an energy strategy and to make up for imperfections in the market may prompt governments to orient the choices made by various means by consumers (i.e. restrict their possibilities in which to choose).

Thus, the imperfections of the market (lack of information, lack of competition) may be corrected by means of structural measures (informing the consumer, modifying decision-, production-, and distribution-circuits with medium-term effect), or by means of regulatory measures (standards, quotas) with immediate effect permitting acceleration of the return to optimal conditions. Likewise, the energy policies of the different governments (such as self-sufficiency or a safe supply situation) may prompt them to adopt aggregative measures (measures of safeguard) or specific measures (financial aid to producers and consumers).

4. The Evolution of the French System

In France, energy-consuming equipment for many years has been chosen--in most cases--in the light of a stable price or even a decreasing price for energy (in prices of a given year). Such equipment is completely ill-adapted at the present time and will continue to be in the future, if we consider that the price of energy is very unlikely to fall back to its previous level.

In 1974, consumption of energy fell to a level of 4% below forecast level. In 1985, the figure may well drop to 20% or 25%. Quantitative analysis (aggregate or sectoral) of consumption, at least in the case of France, points with certainty to a growing effect in time of the variation in the price of energy. The use of private automobiles constitutes a market which is well-adapted to high prices. The rather high taxation of highway fuels, and the rather acute realization by the consumers of the high cost of their fuel purchases prompted automobile

manufacturers to orient their efforts toward models consuming a minimum specific amount of fuel. On a short-term basis, the consumer reacts to price hikes mainly by using his vehicle less. Overall consumption has decreased in 1974 as compared to 1973. The overall decrease was accompanied by a transfer of purchases to regular gasoline (lower octane fuel) which is less expensive. It is not easy to assess the past influence of prices on consumption. One notes, however, that gasoline (petrol) apparently has a positive elasticity (with respect to the real price) of 0.25, while premium grade gasoline (petrol) has a negative elasticity of 0.9. For the aggregate of the fuels, the elasticity seems to be about 0.35.

The effect registered in 1974 is coherent with this estimate. Regulatory measures, which at any rate have more to do with problems of safe driving (speed limitations) are absolutely inadequate to explain the drop in consumption. The increase in consumption noted in the first quarter of 1975 confirms these conclusions, if we take into consideration the fact that the real price of fuels has gone down.

On a medium-term basis, the evolution of consumption will proceed at a slower tempo than has been forecast, due to the influence of three factors:

- the slower tempo of equipment installation or renewal;
- the lower total mileage covered; and
- the lower specific consumption.

At the present time, it is estimated that in 1985 the consumption figure may be from 15% to 25% lower than the level that had been forecast previously.

The domestic heating market features different characteristics. It is a competitive market in which all forms of energy compete with one another. Under the influence of a rising standard of living and a decreasing real price of energy, total consumption has rapidly grown. It thus appears today to be the

perfect example of a market that is ill-adapted to new prices, and one in which long-term elasticity could differ from short-term elasticity.

On the immediate plane, the agents' possibilities of reaction are relatively great, even if they do lead to a loss of satisfaction (reductions of indoor temperatures, shorter heating periods, improved efficiency due to better upkeep or good regulation). Taking the favorable weather conditions into account, the drop in consumption in 1974 was a sizeable one (in the vicinity of 17%).

On a medium-term basis, new buildings will be adapted to expensive methods of heating through better insulation which will permit a return to the previous level of satisfaction for a consumption of energy which will be 30% to 40% lower.

Finally, the industrial heating market features great rigidity on a short-term basis. Aggregate consumption is linked to the level of production. Substitution possibilities, on a short-term basis, are limited, in France, to electric power plants. In 1974 and 1975 the consumption of heavy fuel by industry has evolved practically as has industrial production: the saving can be assessed at 2%.

Conversely, on a medium- or long-range basis, technological modifications will make it possible to decrease the consumption of energy per unit produced and to carry out substitutions between forms of energy.

Energy Demand and Optimization of the
Energy Choices

D. Finon

Introduction

The upheaval of the energy situation in France, due essentially to the increased price of crude oil, invalidates the use of classic methods of extrapolation from the past in order to estimate energy consumption further than five to ten years ahead. Extrapolation methods take the evolution with time of certain basic parameters of the economic configuration (income, industrial production, price, technical progress, etc. and try to assess the future evolution of energy consumption, with the help of econometric laws which assume the existence of causal links (using the coefficients of elasticity, for example). But it is not sufficient to have determined a certain tendency in the past, to pretend to have discovered its laws of development without demonstrating, if necessary theoretically, that the presumption that these laws are valid for the future can in fact be justified.

In fact, the basic foundations of this methodology weaken these causality bonds: the prediction assumes the determinants of the consumer's behavior are unknown, but observation of past consumer behavior brings to light certain systematic aspects. These then can be described by a mathematical model which is chosen to take into account the aspects considered important, and the use of this model to establish predictions for the future depends upon the postulate that the energy system (production and consumption) will be reproduced in the same way as in the past and in a more or less identical environment.

In particular, this amounts to supposing that energy consumption will develop by the same mechanism as in the past. These hypotheses are no longer acceptable in the new energy situation, which corresponds to a period of adaptation to the abrupt rise in the price of hydrocarbons. In fact, there is reason to set aside the existing econometric laws--laws which amount to ignoring and rejecting a priori all the possibilities of fighting against the waste of energy or in the substitution of capital for energy, which will be essential in the future evolution of the energy system.

In order to do this, it is necessary to use methods which bring to light more explicitly the factors which determine energy demand (fundamental requirements, socio-economic variables, that is to say phenomena such as urbanization, the private car, the need of comfort) and which take into account the different processes and techniques of the use of energy, which are more or less "energy intensive."

One of these methods could be an analytical approach consisting of the long-term optimization of the whole energy production and consumption activities. This would be the logical continuation of a certain way of energy modelling already carried out in many places, especially in France at the Institut de l'Energie de Grenoble.

The model "ENERGIE"¹ which has been developed there is a linear programming model minimizing, in the long-term,²

¹See D. Finon, "Optimization Model for the French Energy Sector," Energy Policy (June 1974), 136-151; D. Finon, "Un Modèle d'optimisation du Secteur de l'énergie," Revue Française de l'Énergie, 261 (March 1974); and D. Finon, "Le Modèle 'ENERGIE', Essai d'Optimisation du Secteur Français de l'Énergie." Thesis, Grenoble, March 1975.

²For the period 1975-2020.

cost of final energy supply to the community, which also takes into account the different political objectives such as reducing energy dependency, the security of supply, and the limitation of effects on the environment.

By the attendant realization of the different types of choice at each energy branch, the optimization of the program enables one to determine:

- 1) the balance of primary energy, by form of energy and by origin;
- 2) the structure of the production of the different energy branches (that is to say, the capacities of the different equipment constructed at different dates) together with the distribution of the different energies in intermediate rival fields.

In order to do this, the different energy production processes have been represented with the help of a graph which starts from the production of the primary energy and finishes with the supplying of the final energy to the consumers. In its present form, the model also includes the choice between the secondary forms of energy for the rival fields of domestic and industrial thermal uses. The requirement levels to be satisfied are therefore expressed in effective energy for these rival fields and in final energy for the specific uses of a specific form of energy. The choices at the level of final consumption are therefore based on the utilization yield and the equipment outlay, and enable one to determine the definitive structure of the energy consumptions.

Other models of this sort have been developed in the world, whether in western countries³ or in socialist countries.⁴ As for the model "ENERGIE" some components include the optimization of certain consumption processes.⁵ It also proves to be of interest to systematize this representation of energy demand by considering two submodels, a submodel of production and a submodel of consumption. The latter--which it would be of interest to develop more extensively than is done in the present work--will optimize all the consumption processes from the level of obtaining the effective energy (that is to say the calorific, mechanical,

³See, for example in Mexico, the model "ENERGETICOS," "Multilevel Planning: Case studies in Mexico" (North Holland 1972), pp. 233-290; and in America, the Brookhaven Laboratory Model (K. Hoffmann, "A Unified Framework for Energy System Planning," Proceedings of IIASA Planning Conference on Energy Systems, July 17-20, 1973 (Laxenburg, Austria, International Institute for Applied Systems Analysis, 1973)).

⁴See, for example in Hungary, Sovary and Pikler, "Economic Principles for the Selection of Energy Sources," in Hungarian, Műsaki Elet, 15 (1969), and in Bulgaria, Kostadinov, "Economico-Mathematical Model for the Optimization of the Energy Resources of the People's Republic of Bulgaria," Econometricska Misal, 3 (1968).

⁵The Mexican model already cited includes, for example, the choices between siderurgical processes; the American model includes the choice between energy agents in siderurgy and in the domains of domestic and industrial thermal uses and air conditioning systems; the Hungarian model considers twenty-eight groups corresponding to a precise use and technique (cooking, domestic heating, industrial heating, cement ovens, brickworks, chalk, glassworks, bread ovens, etc.).

chemical, or luminous energy actually used)⁶ to the supplying of the different forms of final energy to the users. This optimization will allow the levels of final energy consumption (that is, the production objectives of the producer sector) to be determined by minimizing the cost of utilization of the different energies, the production objectives being the fundamental requirement levels of each user.

The basic ideas of this method of optimizing energy consumption are in opposition to those of extrapolation from the past:

- a) the consumer's behavior is perhaps not known precisely but it is reasonable to suppose it is rational. A study of the past allows the realism of this hypothesis to be verified;
- b) the step implicit in the research of the sector optimum supposes a rational sector allocation,⁷ practicing a policy of marginal cost pricing for production and selling, a policy which allows the realization of an optimum for the energy sector compatible with the optimum for the collectivity. It is neither absurd nor incoherent to suppose it possible to optimize the whole of the energy consumption processes in the same way.

This approach is open to two possible interpretations:

⁶In order to employ a vocabulary which does not give rise to confusion, we shall use the term "energy agent" to designate the different combustibles or electricity in as much as the real "forms of energy" are the mechanical work, the heat, or the luminous energy which they are supposed to supply. The term "energy vector" will be employed to designate the support of the energy from the entry in the consuming machinery to the effective use of the form of energy in the equipment under consideration (for example the vapor or hot water). One could discuss the merits of these terms but, stated thus, they at least help to avoid confusion.

⁷Implicitly the approach refers to a planning organization responsible for the elaboration and application of energy policies whose field of action covers the whole group of energy production activities.

- 1) Each energy consumer has a rational behavior, which enables one to "separate"⁸ the optimization of the parameters of his energy consumption and the optimization of the rest of his activities (consumption of other goods, production of outputs). Note that it is necessary to underline clearly that to "separate" the optimization of energy consumption activities from other activities of the agent under consideration signifies that the corresponding program should verify the conditions of "separability" compared to the global program for this agent. In fact, these conditions sometimes necessitate enlarging the program, taking into account certain interdependencies of the optimized field and certain parameters external to it.

- 2) The field of competence of the sectoral allocation will include the demand for a "form of energy."⁹ What the sector sells is always the different energy agents, but the price of these is defined in

⁸Explicit reference is made here to the theory of separability of a program, developed in France by F. Bessière during the sixties. (See in particular F. Bessière, "La Méthode des Modèles Elargis: Application à un modèle de choix des Investissements," 25 Ans d'Economie Electrique, pp. 227-240; and F. Bessiere and E. Sauter, "Optimisation et sous--Optimisation: la Méthode des Modèles Elargis," RFRO No. 40, 1966. It constitutes one of many variations of exploitation of the decomposition algorithm of Dantzig-Wolfe, the mathematical base of most of the planning methods decentralized by prices (or quantities). Separability will be used here mainly intuitively, not rigorously. Our aim is in fact to use the decentralization property of an optimization program in an informal way. It is probable that mathematical verification of our affirmations would involve reviewing one or another points of our method.

⁹This term is defined in footnote six above.

such a way that the implicit price of the "form of energy" demanded is related to its marginal production cost, that is to say, taking into account the production costs of the energy sector and the utilization costs of the consumer. The program for the energy sector, enlarged to include energy consumption should remain separable from the program for the whole of the economy.

Without formulating this last program mathematically,¹⁰ it would appear that the realization of the "separability" of the consumption submodel and this program is very different depending on the consumers and the uses, taking into account the variable importance of the interaction between the consumption of an energy agent and the characteristics of the technical capital, whose functioning necessitates the use of this agent. The principles of the representation of energy consumption processes will give rise to the characteristics (at least intuitive) of separability at the level of each of the consumer sectors and each type of use.

1. The Principles of the Representation of the Consumption of Energy Processes¹¹

1.1 The Strong Interaction Between Energy Agent and Technical Capital

This is the case of the large energy consumer sectors where the expenditure of energy constitutes a large part of the total cost and where the possibility of substitution

¹⁰Not formulating the whole group of programs for each energy consuming economic agent is practically the same thing.

¹¹The divisions of consumption which follow are similar to those in the trial of analytical approach to the evolution of energy consumption in the long or very long term made at the IEJE by B. Château and B. Lapillonne in "Projection à Long Terme de la Consommation d'Énergie en France," synthesis report.

between production factors, and in particular between energy agents, is small. The substitution of one for the other is only possible by changing or modifying the technological processes.

To define the future requirement levels of these sectors, which are to be satisfied in the submodel of consumption (that is to say the bounds of non-inferiority of supply constraints), one needs to distinguish two cases:

- a) If the horizon of optimization time does not allow one to envisage any possibilities of substitution due to the dominance of a given process and to the improbable access at the stage of economic maturity of eventual technological innovations, the use of the agent can be considered as being specific. If it is not possible to improve the dominant process, the demand for the "form of energy" is inseparably bound to that of the energy agent by which it can then be represented.
- b) If several processes are used or are potentially usable or if, between now and the end of the period under consideration, certain processes become viable, then the fundamental energy requirement is best conveyed by the output production level which constitutes the essential determinant of the energy demand of the industrial sectors. In fact it is possible to consider the production level as reflecting, more or less, the required transformation work necessary, taking into account the different processes already existing which the submodel will consider explicitly. This

schema can be applied to the following sectors and products (the list is not exhaustive) in Table 1.

Table 1.

| SECTOR | REPRESENTATIVE OUTPUTS |
|-------------------------------|-------------------------------------|
| iron and steel | steel, cast iron |
| non-ferrous metals | aluminium, alumina |
| ferro alloys | ferro alloys |
| non-metallic mineral products | cement, lime, bricks |
| paper | paper paste, cardboard |
| chemicals | rubber, chlorine, nitrogen, ammonia |

It is necessary to specify that, for a given sector, these products do not necessarily enable the whole of the sector's processes and activities to be covered; the parts of the sectors excluded by this representation have to be treated in the section of the model concerning the other consumer sectors.

This representation can also be applied to the transport sectors. In order to better understand the real situation, these should be disaggregated by transport type

(passenger transport--urban and inter-city, road haulage etc.) which best characterizes the given service. It is easy, then, to confuse the fundamental energy requirement with the transport requirements which can be satisfied by several modes (or means) which, taken into account explicitly in the submodel, will be the object of arbitration at the time of optimization (see Table 2).

Table 2.

| TRANSPORT TYPE | REQUIREMENT CHARACTERISTICS |
|-------------------------|-----------------------------------|
| Passenger transport: | |
| Urban | Number of passengers |
| Inter-city | Number of passengers x km |
| International | Number of passengers x km |
| Road haulage: | |
| Inter-city | Number of tonnes x km |
| International transport | Number of tonnes x nautical miles |

1.2 The Looser Interaction Between Energy Agent and Technical Capital

The rest of the industrial sectors, the tertiary and domestic sectors, allow a different kind of representation. In fact, in the rest of the industrial sectors, a weaker relation of the energy agents to the technical capital characteristics is observed. This is most often the case for the middle-size industries or small energy consumers¹²

¹²The percentage of energy expenditure in the output cost price is less than 4%-5%.

whose production is diversified in a certain number of products and processes not easy to aggregate. While this latter characteristic leads one to hope for the separability of the energy arbitrations among the contractors for other economic choices, the first characteristic allows one to presume this is more or less already realized. The demand can then be represented by that of the different forms of energy, thermal energy (high temperature heat, low temperature heat, heat for the purpose of heating buildings), mechanical energy (fixed motive force), luminous energy (lighting), etc.

At the domestic and tertiary sector levels which can be aggregated from the point of view of energy behavior, the problem of enlarging the substitution model is not encountered since these are final energy consumers. The technical and economic characteristics of the different energy agent consumption processes are therefore taken into account in the factors which determine their demand. It is possible to distinguish between the thermal energy requirements to heat buildings and supply hot water, and the requirements corresponding to the running of appliances (motive force, domestic appliances, air conditioning, refrigeration) a predominantly electrical domain.

When there is only one unique process in any given domain able to supply the requirements of a "form of energy" for the optimization period, a process which does not have a possibility for improvement or substitution, this demand can be represented (as in the large energy consumer sectors) by the demand for the energy agent consumed. This is the case of specific electricity uses. In the other cases, the substitution model takes into account the different processes which use the energy agent to satisfy the given requirements of each "form of energy" of the different consumer sectors (other industries, residential and tertiary sectors). This second representation schema could be applied to the following sectors and uses in Table 3.

Table 3.

| SECTORS | USES | TYPE OF USE |
|---|---|---|
| Industries metal fabrication food industry, textile industry, building industry etc. | furnace uses vapor uses building heating fixed motive force uses other uses | exchangeable exchangeable exchangeable specific (electric) or exchangeable specific (electric) |
| Agriculture | motive force uses heating uses | specific (carburants or electric) exchangeable |
| Domestic, tertiary sectors; small and cottage industries. | motive force uses domestic appliances uses other uses ¹³ building heating | specific (electric) specific (electric) specific (electric) or exchangeable exchangeable |

To resume, the necessity to "separate," at least intuitively, the optimization program of the group of energy consumption processes from a global economy program leads to the definition of the possibilities of substitution between energy agents. For this, the energy demand is expressed in terms of the fundamental energy or "forms of energy" requirements, this expression enabling the different energy consumption processes to be considered.

In fact, when there exists a rivalry between several processes, this demand is represented:

¹³This takes into account for example bakers' ovens, refrigeration, air conditioning, information processing.

- either by the output production levels of the consumer sector under consideration (large consumer industries); or
- by the requirements of transport for the transport sector; or
- by the levels of demand of the different "forms of energy" in the remaining sectors.

When the supply process of this form of energy and, therefore, the energy agent, is unique, the demand is represented by this agent.

1.3. Improvement of the Reality of the Representation

Following from the possibilities of substitution thus defined, it should be possible to draw a conclusion by optimization of an ideal structure of the energy consumption processes group. But it is necessary to improve the reality of this schema by bringing into account certain elements of the real conditions of substitution.

a) The Physical Characteristics of the Energy Agents

These can bring a consumer or a user to prefer one energy agent or another, with the same price for the usable (or efficient) therms. It is thus for gas due to its cleanliness, its ease of handling, the ease of regulation of the burners and atmosphere temperature control¹⁴ and, finally, due to the absence of storage necessary for the consumer. Electrical energy, when its use is justified from the economic viewpoint¹⁵, presents even

¹⁴This is necessary in certain dryings and cookings.

¹⁵This is not the case in industry for vapor uses.

superior qualities to gas. On the contrary, coal is not attractive even if only compared to petroleum products, due to the large storage space necessary, the difficulty of handling, the rapid choking up the burners, etc. Quality premiums can therefore be placed on the energy agents to be preferred.

b) The Rigidity of Behavior Principally Owing to the Length of Life of the Appliances

Whatever the consumer sector and the energy uses considered, the substitution of one energy agent for another can take place in several ways:

- either the reconversion of existing equipment, by changing the burners in the case of thermal uses for example; or
- the substitution of one process for another at the moment of changing obsolete equipment; or
- the choice between different processes at the moment of designing a piece of equipment to extend the existing store of consumer equipment.

The substitution in certain consumer domains, such as the large consumer industries essentially take the last two possibilities. In the same way, replacing combustibles by electricity necessitates a complete change of equipment. The pliability of consumption differs therefore from one consumer to another and from one process to another. The rate of modifications, which results from a change in the relative prices, differs enormously: It is true that everything depends on the amplitude of the change which, following its size, can have diverse consequences, varying from the modification of polyvalent equipment to the accelerated change of most of the consuming equipments. However, it is necessary by some means or another to

integrate these rigidity factors of energy consumption by explicitly taking into account the equipment, its age and length of life.

2. Proposition of a Possible Formulation of a Submodel of Optimization of the Consumption Processes

As it has been pointed out, the program to be optimized is the program to minimize the satisfaction cost of the levels of demand of the different "forms of energy" from the buying of the energy agent to the end of the consumption processes. The formulation will vary from one sector to another and from one user to another due to the difference in the "separability" of the problems encountered at each of these levels.

2.1 The Large Consumer Industries

The representation of the processes can be more or less true, more or less disaggregated. In the first instance, they will be formalized very simply by the quantities of inputs associated with the fabrication of one unity of output. Take, for example, the iron and steel industry. Consider four processes in the production of steel, characterized by the quantities of minerals, irons, coke, fuel, natural gas or electricity used to produce one tonne of steel.

These processes can be characterized economically by the annual unitary capital and labor costs or by separating variable costs, fixed costs, cost of investment (which, in this case, inhibits the explicit taking into account of the capacity of the equipment). The formulation in either case remains very simple.

Thus i is the particular process and x_i the quantity of steel produced annually by this process corresponding to a technique already optimized (size of the appliances,

recuperation of heat or gas, etc.). This process can be characterized by the unitary coefficients of consumption of each of the products considered:

| Minerals | Scrap iron | Coke | Coal | Gas | Fuel | Electricity |
|----------|------------|-------|-------|-------|-------|-------------|
| a_i | b_i | c_i | d_i | e_i | f_i | g_i . |

The total requirements of these products for steel production can be deduced from this, taking into account the production of steel x_i by each of the processes i :

mineral requirements: $\sum_i a_i x_i$,

scrap iron requirements: $\sum_i b_i x_i$.

The iron and steel section of the substitution model will be written taking into account explicitly the equipment.¹⁶

a) Constraints

- satisfaction of the steel requirement A : $\sum_i x_i \geq A$;

- limitation due to the availability of products (facultative) $\sum_i a_i \cdot x_i \leq M$ for example

where M is the availability of minerals;

- limitation due to the capacity: $x_i \leq C_i + X_i$ where X_i is the unknown capacity of the equipment i and C_i its original capacity.

¹⁶The mathematical expression, given here, is not indexed by the time for reasons of simplification.

b) Objective Function

If P_a, P_b, \dots, P_g are the prices of the different products used with C_i the variable exploitation costs of the process i , and I_i its unitary investment cost integrating the amount of fixed costs after discounting, then the function of the costs to be minimized can be written:

$$P_a \cdot \sum_i a_i \cdot x_i + P_b \cdot \sum_i b_i \cdot x_i + \dots + P_g \cdot \sum_i g_i \cdot x_i + \sum_i c_i \cdot x_i + \sum_i I_i \cdot x_i \quad .$$

This formulation¹⁷ is elementary, simplistic even. It could be improved eventually, by allowing certain substitutions between combustibles, by integrating the possibility of choice for the year of dismantling, but also by using the integer programming, which would allow one to abstract the hypothesis of the perfect divisibility of the iron and steel equipment which is possible because of the importance and the differences of the unitary sizes of the different equipment.¹⁸

c) Simplified schema of the processes to be noted¹⁹
is as follows:

¹⁷The scrap iron injected during the production of steel by the different processes comes from the rolling wastes (60%). This scrap iron should be considered differently from that bought on the market.

¹⁸The optimal size of the direct reduction gas equipment is one million tonnes per year compared with the three to five million tonnes of the classic reduction coke equipment.

¹⁹The information used to illustrate this paragraph was taken from a study of B. Lapillonne, "Analyse des Besoins d'Energie de Branches Industrielles Fortement Consommatrices," IREP, January 1975. The sources of information have been the publications of the IRSID and the Chambre Syndicale de la Sidérurgie.

1) Classic Blast Furnace Process

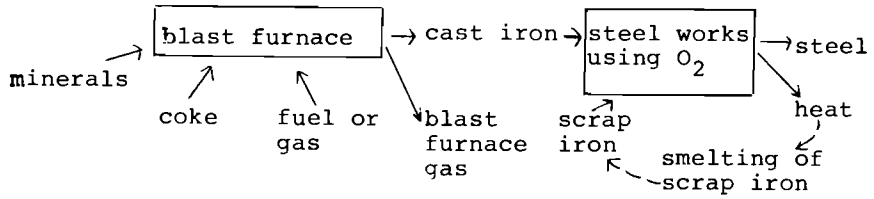

2) and 3) Direct Reduction HYL and MIDREX

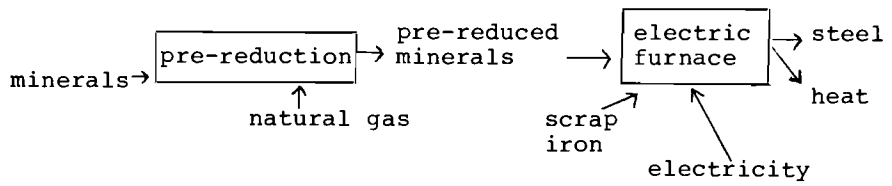

4) Electric Scrap Iron Furnace

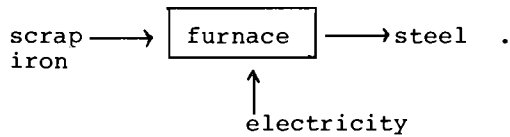

We note that other processes will be usable though they are not yet perfected for industrial use:

- the SLRN processes, whose reduction stage uses solid reducers, even poor reducers (lignite, peat, vapor coal) and which can be applied to poor minerals;
- other processes of direct reduction (FIOR and Purofer processes); the FIOR process uses hydrogen as the reducing agent;
- electro reduction by small furnaces which is not considered economical.

The characteristics of these processes could aid the eventual construction of a submodel of this type. These characteristics are given in quantities of products necessary for the production of one tonne of steel, presupposing the introduction of scrap iron, and therefore, cast iron (or pre-reduced minerals), for the production of one tonne of steel (see Table 4).

This approach can be generalized to other large energy consumer industries and to the transport sector. Since it is not necessary here to define the optimal structure of each of these different branches, the formulation can remain relatively simple (see Table 5).

2.2 The Thermal Uses of the Other Consumer Sectors

In other industrial sectors and in the tertiary and domestic sectors, the different consumption processes designed to satisfy the requirements of a particular "form of energy" and defined from the moment of purchasing the energy agent are represented by a succession of operations whose yields depend on the layout and design of the consumer equipment.

Table 4.

| Process | Minerals by quantity of iron contained | Scrap Iron | Coke + Fuel (kg) ³⁾ | Coal ³⁾ (th) | Gas ³⁾ (th) | Elec. (kwh) | Cost of investment ⁴⁾ | Labor cost |
|-----------------------------|--|------------|--------------------------------|-------------------------|------------------------|-------------|----------------------------------|------------|
| Classic (1) (2) | 850 kg | 150 kg | 315 | 360 | | 125 | 550 F/t | ? |
| | | | 350 | 1,240 th | | 160 | | |
| HYL | 730 kg | 300 kg | - | - | 3,400 | 600 | 405 F/t | 7.5 F/t |
| MIDREX | 730 kg | 300 kg | - | - | 2,835 | 744 | 395 F/t | 3-4 F/t |
| Scrap Iron Electric Furnace | - | 1,000 kg | - | - | - | 600 | 200 F/t | ? |

1) Corresponds to the treatment of rich minerals.

2) Corresponds to the treatment of poor minerals.

3) In the classic process, up to 290 kg of scrap iron can be introduced. It is a function of the scrap iron market and, in 1973, settled at the 150 kg level. On the other hand fuel injections are variable. The rate at the moment varies between 48 and 54 kg of fuel per tonne of steel. Th = therms = 105 btu.

4) The investment costs are given in francs per tonne installed (breakdown for the process): Blast furnace: 220 F/t cast iron; Steel works: 180 F/t steel; Raw Material Store and Infrastructure: 150 F/t.

Source: The work of B. Lapillonne (see footnote nineteen above).

| Table 5. Examples of the rival processes in some sectors. ¹⁾ | | |
|---|--|---|
| OUTPUTS | PROCESSES | REMARKS |
| Aluminum | Bauxite - electrolysis of alumina | Dominant process (15,000 kwh/t, 7,000 th/t) |
| | Bauxite - electrolysis of aluminum chloride | ALCOA process under experiment (12,500 kwh/t) |
| | Nepheline electrolysis of alumina | Process used in socialist countries |
| | Recycling of aluminum wastes | Process only using 1,000 th/t |
| Cement | Clinker production by wet process (variation of the additives) ²⁾ | 1,400 - 1,500 th/t clinker |
| | Clinker production by dry process (variation of the additives) ²⁾ | 850 th/t clinker |
| Paper | Rivalry between many kinds of paper paste using varying degrees of energy | Mechanical paste: 1,200 kwh/t kraft paste: 8 t vapor/t 700 kwh/t |
| Chlore | Electrolysis using mercury | 4,000 kwh/t |
| | Electrolysis using a diaphragm | 3,300 kwh/t |
| Urban passenger transport | Metropolitan - railway electricity | Taking into account social costs |
| | Bus (carburants) | |
| | Private (carburants, electricity) | |
| Intercity passenger transport | Railway (electricity, distillates) | Taking into account infrastructure costs |
| | Private car ³⁾ (carburants) | |
| | Airplane (kerosene) | |
| Internal road haulage | Railway (electricity) | Eventual limitation of capacity of transport. Taking into account the infrastructure costs. |
| | Waterways (distillates) | |
| | Road (diesel oil) | |

¹⁾ The information in the first part of this table is taken from the work of B. Lapillonne, see footnote nineteen above.

²⁾ The additives (slag, etc.) which can constitute up to 40% of the cement allow the economizing of the energy necessary to produce the part of the clinker which they replace.

³⁾ Different horse powers could eventually be allowed for.

a) Take, for example, the vapor-uses in a large fabrication group: this group requires a certain amount of heat between 300°C and 400°C which corresponds to the level of consumption to be satisfied. To supply this heat there is a succession of equipment: the burner, the boiler, the heat exchangers and the pipes. This corresponds to the following group of operations:

- 1) the transformation of the energy agent (here the combustible) into heat by combustion in the burner;
- 2) the transfer of this heat to the transport vector, constituted by water vaporization from raising the water's temperature in a boiler;
- 3) the transport of this heat by the "vapor" vector in the boiler pipes to the technical installations; and
- 4) the circulation of this heat in the pipes of the installations which use it, which heat should create and maintain a given temperature:

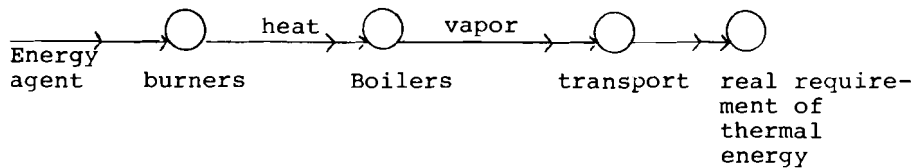

b) The heating of buildings can be represented schematically in the same way replacing the vector "vapor" by the vector "water" (or "air"). However, it is necessary to differentiate between the different buildings (rural house, town house, block of flats) and between the different kinds of heating, which are characterized by the distances covered by the heat carrier (for example,

individual central heating, collective heating, urban heating).

In order to simplify the representation of these two cases, it is possible to consider only three operations by grouping together the first two (burners and boilers).

Type 1:

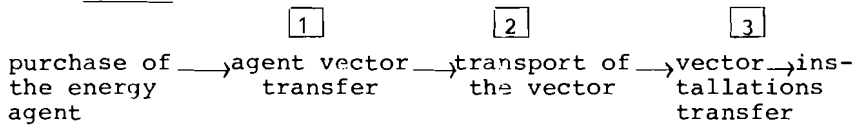

c) In the case of oven uses (glasswork furnaces, drying, cooking ovens, etc.), no vector is used, the thermal energy being transferred directly from the energy agent to the oven either on the inside or through the walls. There remain therefore only two operations.

Type 2:

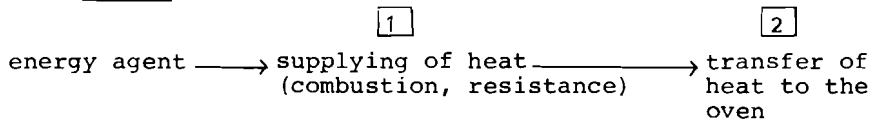

A yield for each operation is defined as the ratio of the quantity of energy out to the quantity of energy in:

- utilization yield for the first operation of the two types of chain;
- transport yield for the second operation of the first type;
- adequate yield for the last operation of both types.

This latter, which is characteristic of the technical installations used, is defined as being the ratio of the fundamental requirements of the "form of energy" considered for the quantity of this "form of energy" brought by the vector

in the first case or reaching the product to be heated in the second case. These fundamental requirements are more or less easy to define in industrial uses: they correspond to the quantity of energy necessary to create and maintain a given temperature in order to operate, for example, the drying, the cooking or the distillation of different products. They are more difficult to specify in the case of heating buildings: they do correspond to the same function of creating and maintaining a certain temperature in the buildings. On the one hand, the level of this temperature depends on the habits of comfort and, on the other hand, the quantity of energy to be provided depends on the volume of the buildings to be heated and their insulation. Because of this, we will define the fundamental requirements in certain very precise conditions (temperature level and volume of the given buildings at their maximum degree of insulation).

These simplifying representations could be considered elementary compared to the much more complex technical reality. Perhaps there could be reason to provide for other types of chains (for the successive uses of heat or mixed production vapor--electricity for example). Perhaps it will be necessary to refine the notion of the fundamental requirements of calorific energy of the different consumers in so far as this requirement, as it is defined here at the end of each chain, depends on the level of the known technologies; the future levels taken here could therefore be open to important variations due to technological innovations not accounted for. But here the objective is to define a formalized approach to the energy demand which is operational, and this consequently introduces simplifications.

Armed with these schemata, it is possible to represent the different processes which could be used to satisfy the same uses in certain rival domains of the industrial sectors and the tertiary and domestic sectors, a domain consisting

essentially of thermal uses. A formalization, made possible by this representation, will be used to improve the example of domestic heating.²⁰ The requirement of heat for domestic heating should be disaggregated by type of habitation (rural habitation, town habitation) and accommodation type (detached house, block of flats) in order to specify on the one hand the volume of the accommodation²¹ and the maximum degree of insulation²² and on the other hand the heating processes which could be employed²³ (see Table 6).

It is possible to multiply indefinitely the kinds of accommodation and heating. The different possibilities for improving burner regulation, boiler design, heat recuperation from smoke, pipe lagging, and building insulation should reduce the number of processes, but remain to be taken into account for any given process. To limit the dimensions of the program, it is necessary to simplify keeping two or three processes corresponding to a series of improvements coherent within themselves (a conception optimal for all the processes against two other conceptions) or supposing, for example, a uniform insulation without possibility of improvement.

²⁰The analytical approach to the evolution of domestic heating requirements has been developed with the help of an elementary simulation by B. Chateau, "Prévision à Long Terme de la Demande d'Energie Finale pour le Chauffage Domestique," Grenoble, June 1974.

²¹Detached houses generally have a greater volume than apartments in blocks of flats.

²²The degree of insulation depends on the number of outside walls; a detached house has five, an apartment in a block of flats has from one to four.

²³It is only possible to use urban heating for blocks of flats or for private houses in urban zones above a certain threshold density.

Table 6. Example of disaggregation.

| Habitation | Accommodation | Method of Heating | Energy Agent |
|------------|---|----------------------|---|
| rural | detached house | Central heating | all combustibles ¹⁾ |
| | | Room heating | electricity and combustibles |
| urban | detached house (in a low-density suburban zone) | see rural habitation | |
| urban | detached house (in high-density zone) | room heating | electricity or combustibles |
| | | central heating | combustibles |
| | | urban heating | electricity or combustibles geothermic refuse residual heat ²⁾ |
| urban | block of flats | room heating | electricity or combustibles ³⁾ |
| | | central heating | combustibles ³⁾ |
| | | collective heating | combustibles |
| | | urban heating | see above |

1) This excepts heavy fuel oil.

2) This comes from power stations on the outskirts of towns.

3) It is only possible to use urban heating in blocks of flats or in houses in urban zones of density above a certain threshold level.

However, here we only describe a simplified, unique formulation of urban heating of an apartment in a block of flats, which can be inserted in the following way in the schema of the heating of the latter (see Figure 1). This formulation explicitly takes the equipment into account. In the representation, the urban power station is assumed polyvalent and of optimal design, the lagging and the distance of transport the same.

Let

- r_1 be the burner-boiler group yield;
- r_2 be the transport yield;
- r_{31} be the adequation yield of apartments isolated one way;
- r_{32} be that of apartments isolated a second way.

Let

- x_1, x_2, \dots, x_{12} be the flux following the lines;
- C_1, C_2, C_{31}, C_{32} be the original capacities;
- X_1, X_2, X_{31}, X_{32} the capacities created between the original date and the date under consideration.

The constraints are:

- the capacity of the urban power station:
 $x_8 \leq C_1 + X_1;$
- the capacity of the transport network:
 $x_1 + x_2 + x_8 \leq C_2 + X_2;$
- urban power station balance:
 $x_8 = r_1 (x_3 + x_4 + x_5 + x_6 + x_7);$

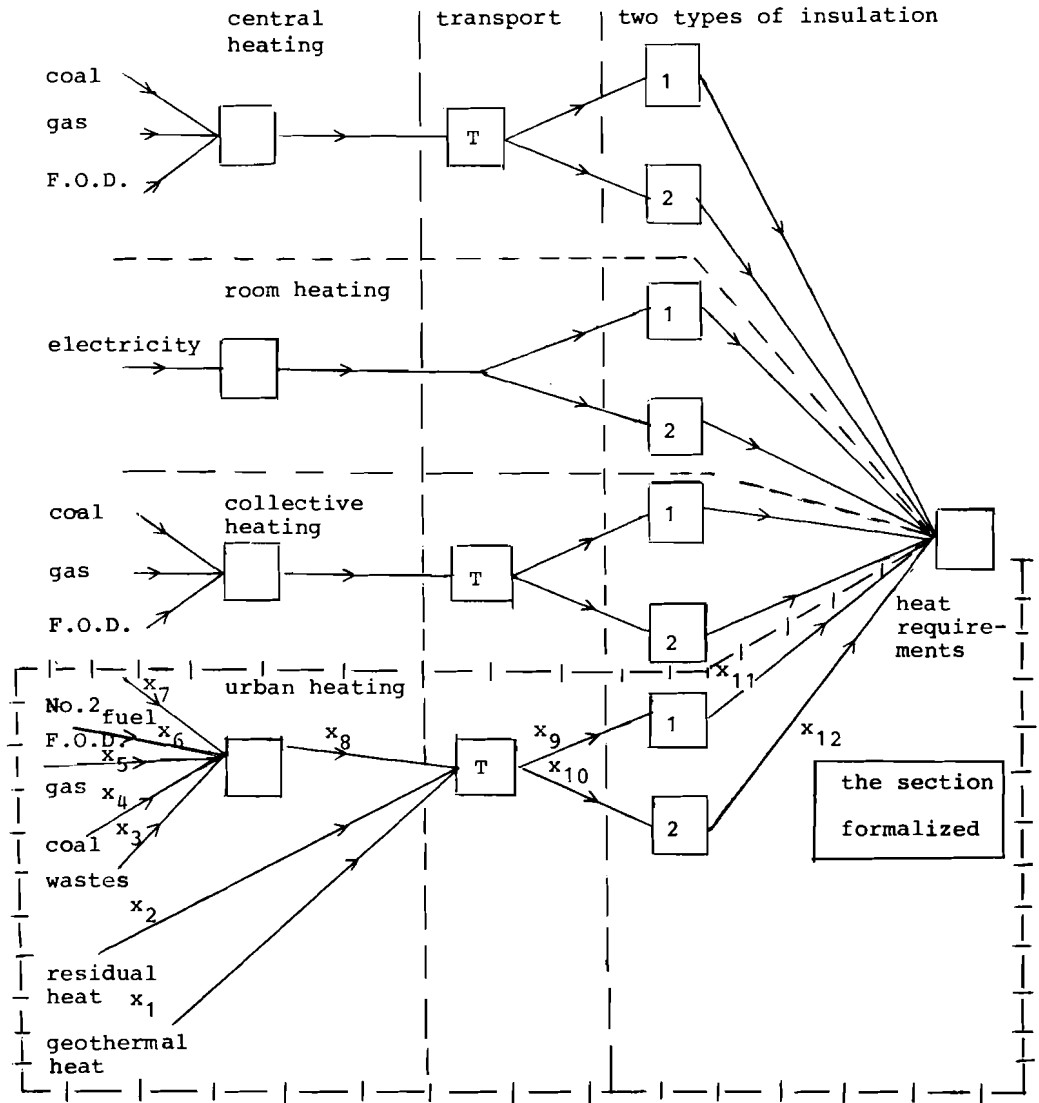

Figure 1.

- transport balance:

$$x_9 + x_{10} = r_2 (x_1 + x_8 + x_9);$$
- balance of accommodation, insulation No. 1:

$$x_{11} = r_{31} \cdot x_9;$$
- balance of accommodation, insulation No. 2:

$$x_{12} = r_{32} \cdot x_{10};$$
- capacity of the accommodation group,
insulation No. 1:

$$x_{11} \leq C_{31} + X_{31};$$
- capacity of the accommodation group,
insulation No. 2:

$$x_{12} \leq C_{32} + X_{32};$$
- satisfaction of the heat requirements B:²⁴

$$x_{11} + x_{12} \geq B; \text{ and}$$
- eventual availability limitations:
 - of geothermic heat (D_1):

$$x_1 \leq D_1;$$
 - of power station residual heat (D_2):

$$x_2 \leq D_2;$$

²⁴B being the total heat requirements of collective accommodation (flats) if all the modes of collective heating of blocks of flats were taken into account here, the heat flux which they would procure would be taken into account in this constraint. Also it is necessary to be precise in that the thermal capacities $C_{31} + X_{31}$ and $C_{32} + X_{32}$ should be evaluated in effective therms; in order to do this, the fundamental heat requirements necessary for a standard volume accommodation are to be multiplied by the total number of No. 1 or No. 2 type insulated accommodation.

- of waste (D_3):

$$x_3 \leq D_3 .$$

The objective function is

$$: \sum_{i=1}^7 c_i \cdot x_i + I_1 \cdot X_1 + I_2 \cdot X_2 + I_{31} \cdot X_{31} + I_{32} \cdot X_{32}$$

where,

c_i is the cost of the different energy agents;

I_1, I_2, I_{31}, I_{32} are the unitary investment costs.²⁵

From this short example, it is easy to generalize to the whole of the heating methods and, more generally, to the whole of the thermal uses. It is to be emphasized that, as in the iron and steel example, it is assumed that the consumer is optimizing behavior (minimizing cost with a given production objective). This behavior, by definition rational, is not necessarily unrealistic, especially insofar as it concerns industrial or collective choices (infrastructure of construction transport, of accommodation, etc.).

This is not the case when it comes to arbitrating between the possible forms of energy at the final demand level especially in the domain of domestic heating; for example, the heating costs are seen differently by those who build the accommodation and those who live in it, the ones being interested in the installation costs and the others in the operating costs (cost of maintenance and combustibles). Faced with this difficulty, it is possible to take refuge behind the normative signification of the methodology (which is the best choice for the community?) eventually adapting the rigidity of this approach by introducing premiums to allow for the psychological preferences. For example, private cars and integrated

²⁵ I_{31} and I_{32} correspond uniquely to the insulation costs.

electric heating have an implicit value due either to the present social values in France, or to the impact of advertising, or other equally diverse factors.

The energy consumption submodel will therefore consist of a group of subprograms, each one corresponding to a consumer type and or a well-defined type of use.²⁶ These will be only indirectly connected between themselves. Only the heat recuperation and mixed vapor electricity production are likely to create direct interdependences between certain of them.

There will be two ways in which indirect connections will be established:

- 1) when the prediction for the parameters of future levels of fundamental energy requirements or "form of energy" demand²⁷ is established. In fact, it is necessary that there is a minimum of coherence between these different provisions which will be established according to a hypothesis of the development of economic activity, the standard of living or the quantity of products requiring a large amount of energy which are imported already half-finished.
- 2) when the prices of the energy agents sold by the producing sector to the consumer sector are defined. These prices form the connection

²⁶ The specific uses (i.e. the specific domains of one unique consumption process and one unique energy agent) which cannot be optimized are excluded from the submodel.

²⁷ This is the production level of large energy consumer sectors, the effective thermal energy requirements of other sectors, and the electricity requirements in captive uses.

between the optimization submodel of the producing sector²⁸ and the optimization submodel of the energy agent consumption processes. At the global production-consumption program optimum, they constitute the equilibrium price between the supply and demand of these economic goods, and are fixed according to their marginal production costs.

The consumption submodel data will be made up by the technical-economic characteristics of the different equipment or techniques (yields, existing capacities, costs) as well as by the provisions of fundamental requirements. There is no reason to underestimate the practical difficulties of grouping together the data of one or another type (for example if the optimization period is long, what happens to the cost of the new technique which could be used?). Establishing the analytical type of provisions remains the major difficulty, especially since the disaggregation of the energy statistics used at the present time does not in any way enable the fundamental requirements, as they have been defined here, to be found. However, it will not be an impossible task if the elaboration of the general plans of the economy give a middle or long-term provision of the economic activity of the different sectors. Apart from this possibility, it is possible to appeal to the different alternative methods such as employing input-output matrices or systems analysis.

The first method (input-output) presents many deficiencies due to its inadaptability to a prospective middle- or long-term use (constancy of the interindustrial coefficients) or because of the incoherence between this method and an analytical approach to the consumption submodel. The second method would, on the other hand,

²⁸See the introduction.

allow the definition of hypotheses coherent for the definition of parameters which characterize the environment of the system to be optimized²⁹ and which would show themselves to be more adapted to the remoteness of the optimization horizon.

The proposed formulation has been developed in a more or less elementary way in the optimization models of the energy sector existing at the present time, as was noted in the introduction. The models for the Eastern European countries are better perfected at this level, which is not accidental as can be seen by taking into account the existence of global plans which are disaggregated by branches, and this favors obtaining the required data. But these attempts enable one to form an idea of what could be done in the way previously described and they suggest, at least in a simplified way, that this approach is viable.

Conclusion

There are many reasons to think that the method of optimization of energy consumption processes removes the difficulties associated with prediction only to replace them at the level of fundamental requirements (output production, "forms of energy" demand). Certainly one must not underestimate the difficulties, but this method has the advantage of avoiding simple extrapolation from the past, a framework which is completely unsuited to the provision of energy later than 1980 to 1985.³⁰

²⁹For example, there is reason to establish hypotheses coherent between economic development, the economic "tertiarization" phenomena, the industrial structure changes (importance of basic industries, etc.) and the importations of half-finished products.

³⁰See for example, "Bilans Energétiques Prévisionnels Etablis par le Commissariat Général du Plan et la Délégation Générale à l'Energie," March 1974; "Rapport du Conseil Economique et Social," Journal Officiel, 25, Annexe 9, 10 (24 Septembre 1974), 1307.

Paths of Energy Consumption for
the Twenty-First Century

J. R. Frisch

The energy crisis has provoked at least one clear result: it is making people and experts think about the evolution of the long range growth in energy needs. At Electricité de France, we are used to dealing with this kind of concern. Already by 1971-1972, we had tackled this problem for a very practical reason: we had to decide whether to stay at the present level of the European interconnected electrical network (380 kv) or to switch to 765 or 1,100 kv voltage level to meet the possible growth of electricity demand.

To answer this question, we had to estimate how the electricity consumption could evolve in the long run (say by the mid twenty-first century); but first we had to get an idea of the level of total energy consumption at that time. Now before we continue, I think that here some reference works could help us to make a few points.

1. Reference Works

Messrs. Weinberg and Hammond have assumed that per capita energy consumption in an advanced civilization could reach twenty kilowatts-thermal, i.e. twenty tonnes coal equivalent (tce)/year (or some 560 million BTU/year and that this could apply to a world population of fifteen billion people.

Fremont Felix proposes from his view point, ten tce/pc-year in 2030 and twenty-five tce/pc-year in 2100 as a world mean level for energy consumption. Some Polish experts suggest a maximum level of twenty-two tce/pc-year.

Thus, a consensus among experts exists at around twenty to twenty-five tce/pc-year in the very long run. As the present mean world level is around two tce/pc-year, it may be realized how long the way to go is. Only an exponential growth path during a long period could meet this proposed level. It means also that every man will someday reach the American level of energy consumption of the year 2000; this is what we could call the "railway theory" where all trains are supposed to pass by the same station but at different times. Behind this idea, we see the postulate of the universal spread of the American way of life.

There is another danger in this kind of assumption. When one multiplies this level of energy consumption by the possible world population, as Weinberg does, one has to face a world consumption of about 300 billion tce a year, and one comes quickly to a terrific picture when it is assumed that this will be provided only by nuclear energy. Far from allowing a sound appreciation of the long range difficulties, this opens the way to reflections leapfrogging ahead over time and forgetting the regulating capacity of the systems and all the necessary transitions between the present situations and the possible doom of tomorrow.

2. An Alternative Proposal

We decided to examine a less brutal evolution for a society more sensitive to the environmental constraints and to the conservation of energy. We proceeded by way of analytical approach.

In the residential sector, the most comfortable solution in the USA leads to 24,000 kWh a year (golden medal of electrical heating), i.e. eight tce per dwelling or about 2.5 tce/pc-year (3.3 tce/pc-year in 1971).

In France, with insulation standards, we can hopefully limit consumption to 15,000 kWh a year, i.e. 1.5 tce/pc-year.

Possible development of solar energy would bring this level back to one tce/pc-year of commercial energy.

In the tertiary sector (commercial, public services and offices), we think that the difference from the present American level will be of the same order of magnitude as observed for the residential sector. Even if, tomorrow, people spend more time outside their homes (than today), they will probably consume no more energy for comfort, eating or entertaining in the place where they work or entertain or travel than at home. Even if the tertiary sector tends to occupy a more important part in production in the industrialized societies, it will be relieved by a quaternary sector (electronics, information, leisure) with low energy needs. Let us take one tce/pc-year for this sector (1.6 in the USA in 1971).

Transportation is the sector where waste is the most obvious. A clear preference for mass transportation and the application of new technologies (such as fuel-cell batteries) would lead to a greater efficiency in energy utilization. Moreover, the compact geographical density in Europe promotes a lesser consumption: 1.5 tce/pc-year seems reasonable (0.6 today compared with 2.5 for the USA).

In industry, two evolutions work in opposite directions:

- on the one hand, the physical depletion of some raw materials will induce additional energy consumption (e.g. recycling, waste processing);
- on the other hand, a profound change in the international division of labor could profit both the industrialized nations and the third world.

The migration of manpower based industries toward raw-material sources in the third world will undoubtedly favor some kind of takeoff in these regions. In fact, in the long run, the main energy consuming industries will certainly develop faster in the developing countries than in Western Europe. So, we could agree on a figure of three tce/pc-year (against two in France and four in the USA in 1971).

All in all, we would obtain seven tce/pc-year as a final consumption estimate, i.e. about eight tce/pc-year for the primary consumption against thirteen in the USA and five in Europe today. This level of eight tce/pc-year (32,000,000 BTU/pc-year or ten tce/pc-year allowing for the uncertainty of the forecast) could be taken as a world average level of energy consumption in the long run. Clearly, this would be a compound of energy levels quite different from one country to the other, according to climate, way and speed of development, and so on. But the question remains, how do we reach this possible, stabilized level?

3. Some Paths for Future Energy Consumption

Let us suppose that all the consumptions tend toward the long range level (eight to ten tce/pc-year) set for an advanced civilization. The paths to this level would certainly be quite different. Some countries have already gone beyond this level (e.g. North America); some are drawing near quickly (Eastern Europe) or rather quickly (Western Europe); some still remain very far behind (the third world). So, if most of the third world countries could hope to reach this level from below, the developed regions are probably bound to reach it from above.

Consequently, one may think of three possible patterns for the long range: the continuous exponential growth (ten, twenty, thirty, forty tce/pc-year); the asymptotic evolution where the stabilized level is reached progressively from below; and the "hump" phenomenon where the present speed of

development is such that before the pace can be slowed down, the consumption has gone too far and must subsequently be diminished to the stabilized level (see Figure 1).

This "hump" theory is interesting because it takes firmly into account the inertia effects which rule energy life. These time constraints originate from three reasons:

- 1) lead time to adapt supply to demand (five to seven years to build a thermal plant; seven to ten years to develop an oil field);
- 2) time to implement novel technologies (twenty-five years before nuclear energy enters the industrial picture);
- 3) time lags embodied in the equipment and in the way to use energy (fifteen years for heavy industrial processes; thirty years for a central heated system in a house).

All those too-often-forgotten constraints slow down the possible substitutions, and the adaptation of the energy system can only come in stages. This can be seen in the present forecasts: in the USA, the lowest forecast for the year 2000 rises to eighteen tce/pc-year; in the USSR, it rises to over thirteen tce; for Eastern Europe it rises to over ten tce; already it is projected as 8.5 tce for the FRG in 1985. We clearly note that a good number of countries are doomed to the "hump" situation.

Even France which has in this matter the advantage of starting with one of the lowest energy consumptions among industrialized countries (five tec/pc-year) would have many difficulties in reaching the projected level (eight to ten tce/pc-year) from below.

Starting in France, from about 265 million tce in 1975, we set a reference forecast at 395 million tce for 1985 and a

recent target at 360 million tce. This means slowing down from a past rate of growth of 5% a year to 3% only between 1975 and 1985. There is no official forecast beyond 1985 as of today. But we may contemplate various evolutions to get finally to eight tce/pc-year in 2050 which, multiplied by the possible 90,000,000 French inhabitants, would lead to 720 million tce (which was the previous forecast for the year 2000).

It may be noted that there is only one way to reach this level asymptotically from below. That one goes through the government's preassigned goal in 1985 and assumes a very strict and conservationist policy beyond (2%, 1%, 0.6% per year). All the other hypotheses would lead past the reference level. But at any rate this goes to show that the French energy consumption will certainly never exceed one billion tce in the long run.

As regards electricity, even if someday it comes to represent two-thirds of the total demand energy (which could reach 800 or 1,000 million tce in the very long range), the generation would amount to a mere 1,600 to 2,000 TWh a year when we expect about 900 TWh in the year 2000.

4. Conclusion

A) On the practical problem, first: from our results, we decided to postpone the decision to switch to a higher voltage level for the electrical grid as the demand for power in the mid twenty-first century will likely remain in the same range as the one predicted for the year 2000. Accordingly, it seems preferable to moderate the movement to higher voltage levels.

B) More generally, it is possible to appreciate the portents of various strategies: either you believe in a continuous extrapolation of the present growth rates which lead quickly to twenty to thirty to forty tce/pc-year or you

bet on a possible long range stabilization of demand around eight to ten tce/pc-year.

But even in this latter case, during a first period, let us say at the turn of the century, the ongoing rate of development and the weight of time constraints are such that you may easily be led beyond this level before you can come back to it from above.

On a world scale, it is an entirely different prospect to face some day an annual energy demand of 300 billion tce (as Weinberg says), liable to keep on growing, or to have to supply a demand which anyhow is intended to culminate around eighty to 100 billion tce. And this means that the slope will remain steep till the year 2000 but beyond the growth rate could slow down quickly.

There is thus a problem of immediate responsibility for the industrialized nations. From now on, they must simultaneously organize the means to meet the future growth of demand and to take measures to keep it within desirable bounds (thus leaving to the third world the fossil energies they need in any case). This is a way to work toward a lasting appeasement and a general stability extremely valuable for the world system. (See Figures 1 to 5 for world per capita energy consumption and for projections of French energy consumption.)

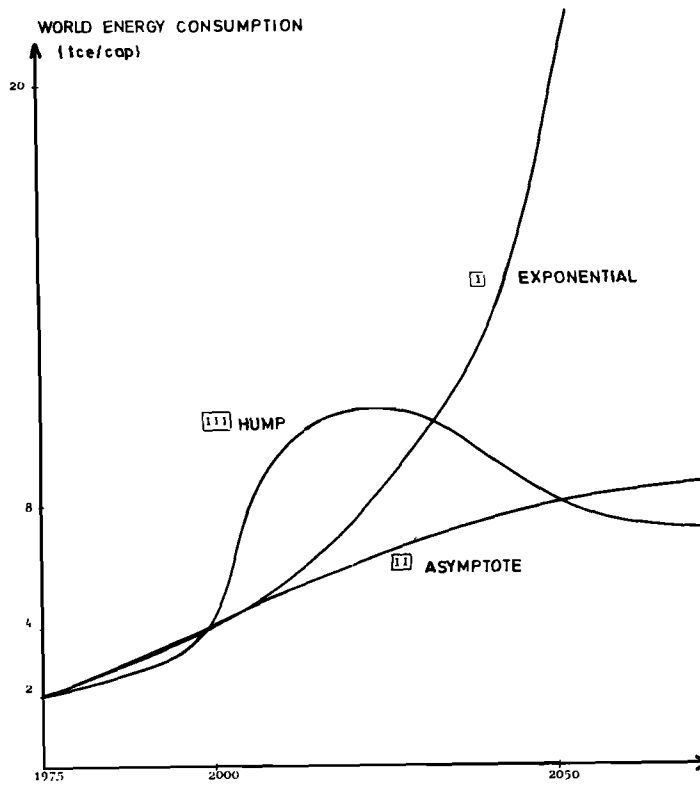

Figure 1. Evolution of the world energy consumption mean level per capita.

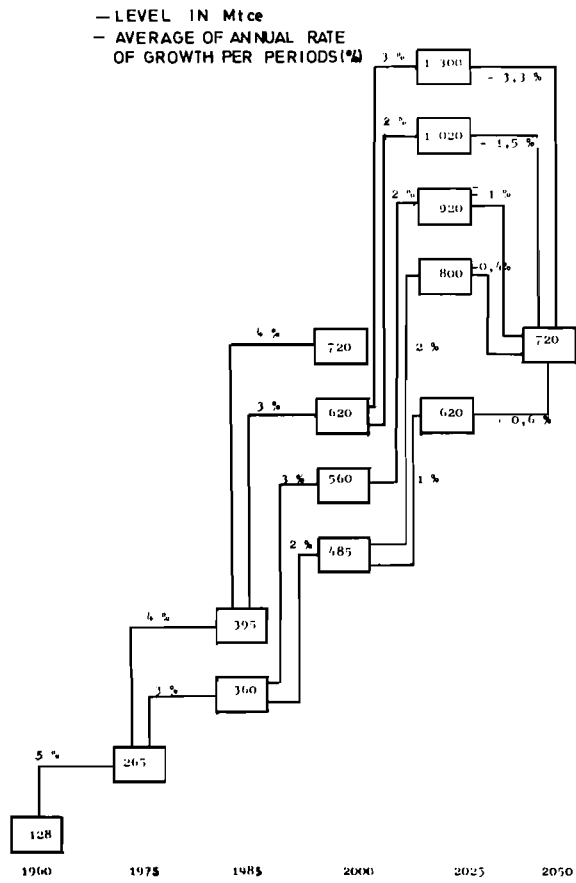

Figure 2. Projection of the total primary energy consumption in France. .

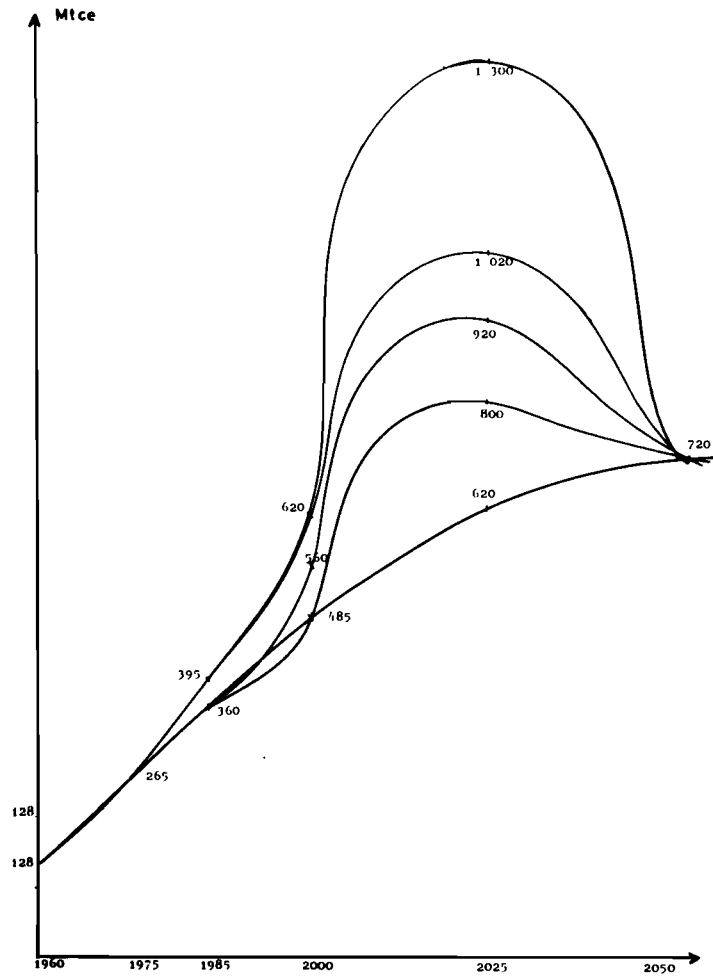

Figure 3. Projection of the total primary energy consumption in France.

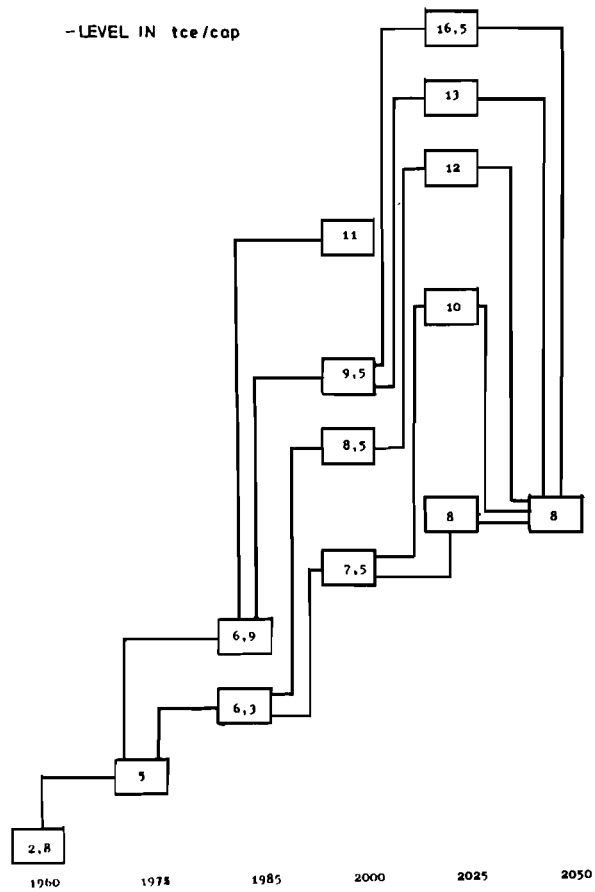

Figure 4. Projection of the total primary energy consumption in France.

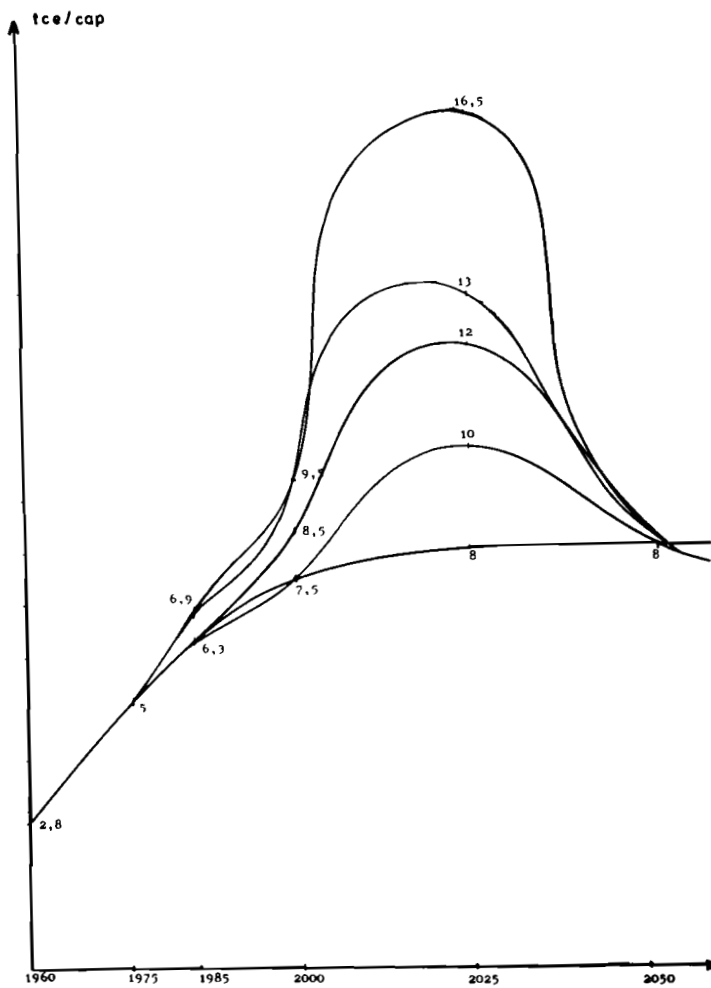

Figure 5. Projection of the total primary energy consumption per capita in France.

The Demand for Energy in Private Households in Austria

G. Tintner and Gabriele Wörgötter

Introduction

This study on the demand for energy in private households in Austria is based on the consumption from 1958 to 1972, of coal, electricity, natural gas, and light fuel for home heating, plus gasoline for private transportation. In the following notes, only those equations which yielded plausible results are recorded. Most estimates are provisional and have to be refined by further investigations. Autocorrelation, multicollinearity and simultaneous relations may be the cause of biased estimates.

Abbreviations Used in the Study

Y ... Real disposable income,
HGT ... Temperature-index,
KFZ ... Number of cars,
DHR ... Average cylinder capacity of cars,
B ... Demand for petrol,
G ... Demand for natural gas,
S ... Demand for electricity,
H ... Demand for oil for heating,
K ... Demand for coal,
PB ... Price of petrol,
PG ... Price of gas (natural),
PS ... Price of electricity,
PH ... Price of oil for heating,
PK ... Price of coal.

All variables (annual data 1958-72) are transformed into logarithms. The estimated regression coefficients are elasticities. The numbers in brackets below are the standard errors of the coefficients. R is the multiple correlation coefficient. DW is the Durbin-Watson ratio.

Demand for Coal

$$\begin{aligned}
 K &= 4.425 - 0.787Y - 2.729PK + 1.269HGT \\
 &\quad (0.112) \quad (0.201) \quad (0.709) \quad (0.447) \\
 R &= 0.817 \\
 DW &= 2.108 \qquad \qquad \qquad (1)
 \end{aligned}$$

Income-elasticity is negative, that is coal is an inferior good. The elasticities are significant (at 5%) and have the expected signs. The price-elasticity seems high. This could be explained through the fact that coal is mainly used by poorer people who decrease consumption as prices rise.

The HGT-elasticity is highly significant, that is consumers change coal consumption according to changing temperature. (This is the case only for coal and not for other energy forms.) Price and income elasticities are significant.

Demand for Electricity

$$\begin{aligned}
 S &= 1.898 + 1.847Y - 0.663PS \\
 &\quad (0.030) \quad (0.171) \quad (0.306) \\
 R &= 0.998 \\
 DW &= 1.590 \qquad \qquad \qquad (2)
 \end{aligned}$$

All coefficients are significant, and the elasticity of income is high. (The increasing amount of electric equipment raises the consumption of electricity more than proportional to income.)

Demand for Natural Gas

$$G = f(Y, PG, HGT): \quad (1) \quad G = 13.021 + 0.160Y - 5.757PG + 0.158HGT$$

$$\quad \quad \quad (0.293) \quad (1.658) \quad (3.277) \quad (1.224)$$

$$\quad \quad \quad R = 0.911$$

$$\quad \quad \quad DW = 0.899 \quad \quad \quad (3)$$

The signs of the coefficients are good, but some of them are not significant.

Demand for Heating Oil

$$H = -8.639 + 4.402Y - 1.194PH + 0.977PG$$

$$\quad \quad (0.159) \quad (1.211) \quad (0.318) \quad (1.977)$$

$$\quad \quad R = 0.986$$

$$\quad \quad DW = 2.056 \quad \quad \quad (4)$$

The elasticity of income is again very high, but significant. The price-elasticity of oil for heating is significant too and has a reliable value (-1.2). The cross price-elasticity of natural gas is not significant, but has the expected sign.

Conclusions

Coal: The best results are with the simple equations, that is those equations which have only a few variables. Of the other prices, only that of natural gas has to be taken into consideration; the others have no influence on the consumption of coal. Coal is the only material whose demand is essentially influenced by changes of temperature. In all cases one has to keep in mind that coal is mainly used by poorer people and so has some peculiarities.

Electricity: Again, we have the best results with the simple equations which have only a few variables. We have to mention that heating oil and coal prices are more important than the price of natural gas.

Natural gas: The estimates of the demand for natural gas are extremely difficult to make because natural gas was increasingly used by the public gas company. Therefore we have a strong bias which finds its expression in the estimated equation. We propose to try an equation including a dummy variable. For all these reasons one cannot give definite conclusions, but at least it is possible to say that other prices have a large influence on the demand for natural gas.

Oil for heating: In all cases we have very high, but fairly significant income-elasticity. Probably it is important that the number of central-heating appliances using oil, which only well-to-do people can afford, increased. Even so, the income-elasticity seems too high. The price-elasticity of oil for heating has reliable values. Among the other prices mainly that of coal is important, although the cross price-elasticity of coal seems a little bit too high. One can see that the price of oil has a big influence on the demand for oil. The prices of natural gas and electricity are not very important for their demand.

The Petrol Model

1) Theoretical

$$KFZ = aY + bKFZ_{-1} \dots \quad (5)$$

$$DHR = dDHR_{-1} + eBP + fY + g \dots \quad (6)$$

$$B = a_1Y + b_1BP + c_1KFZ + d_1DHR + e_1 \dots \quad (7)$$

$$B = AY + B.BP + C.KFZ_{-1} + D.DHR_{-1} + E \dots (8)$$

$$a_1 = A - Ca/b - Df/d$$

$$b_1 = B - De/d$$

$$c_1 = C/b$$

$$d_1 = D/b$$

$$e_1 = E - cC/b - gD/d$$

The equations (5)-(7) are the structural equations of the model. The equations (5), (6) and (8) are given in reduced form.

2) Empirical

Logarithmic Transformation

All variables (annual data 1956-72) have been transformed into logarithms. The coefficients are therefore the estimations of the elasticities.

$$KFZ = -0.076 + 0.388Y + 0.782KFZ$$

$$DHR = 1.4 + 0.788DHR_{-1} - 0.017BP + 0.071Y$$

$$B = -11.062 - 0.178BP + 0.558KFZ_{-1} + 1.717DHR_{-1} + 0.493Y .$$

The estimated equation has the following form (indirect method of least squares):

$$B = -13.570206 + 0.06Y - 0.141BP + 0.713KFZ + 2.179DHR .$$

Interpretation

The direct income-electricity is very low (0.06). Rising income first increases the number of vehicles, and, with an increase in the number of cylinders (the DHR), the consumption of petrol. With these variables constant, changes in income have little influence on the demand for petrol. The price-elasticity is very low because petrol is a necessity. One has to take into consideration that DHR has a great influence on the consumption of petrol.

Long-Term Tendency of Energy Demand and Supply
in the Federal Republic of Germany

F. Hoffmann

Introduction

For the energy economy and energy policy, it is important to estimate future development in the demand for energy and the possibilities of meeting this demand for both the medium and the long term. This has been made obvious especially by the recent development of world-wide and regional energy markets.

We are attempting by means of a model study to analyze the important factors that influence energy demand of the Federal Republic of Germany and to quantify the effects up to the year 2000. The intention was to estimate both the total demand for primary energy and the contribution to be rendered by individual energy sources which seemed to be even more important. Our investigations in the model study have not yet been completed so that today we can only report on our principal procedure and first results.

1. Prognosis of the Demand for Primary Energy in the Federal Republic of Germany up to the Year 2000

1.1 Analysis and Prognosis of the Factors of Influence

As to the factors which influence the demand for primary energy in the Federal Republic of Germany, we were less concerned about taking all interrelationships into consideration than investigating the most important components with regard to their influence on the demand for primary energy.

The development of the population has a direct and an indirect influence on energy consumption. However, the

number of persons is less decisive for direct influence than the number of households. Thus, a proportionality between the population and energy consumption cannot be assumed a priori. Rather an increase in the population could lead to a less-than-proportional increase in energy consumption, and vice versa: in any case, the effects come only with a considerable time lag, namely at a time when the number of households decreases on account of the reduced number of births.

The development of population has an indirect influence, via economic growth, on energy consumption. A reduction of the population has effects on private demand and, thus, also on economic growth and energy consumption. The same applies in reverse for an increase in population.

With regard to economic development there should also be a rather close relationship between the development of the gross national product and the growth of primary energy consumption. However, a difference should be made in this respect insofar as the different economic branches show different growth trends.

The diversity of energy intensity in the various economic branches is of consequence for the development of the energy demand. In all industrial sectors, a further increase in labor productivity can be expected, and this should result in a positive influence on the energy consumption.

In addition to the factors mentioned so far, which could be dealt with here only very briefly, we investigated effects from possible actions using energy more economically and rationally. The quantitatively most important effects should occur in the "household" and "small consumers" sectors (by proper heat insulation, more modern heating

systems, etc.). Smaller possibilities for saving energy are to be expected in the "transportation" and "industrial" sectors, where essential quantities of energy could be saved only by improving the efficiency of energy utilization and by coupling the power and heat generating processes.

Seen as a whole, larger quantities of energy could be saved in nearly all sectors by purposeful actions for a rational and more economic use of energy in the medium to long term. A quantification of such savings appears to be difficult. As for the magnitude of such savings it could be presumed that about thirty to fifty million tonnes of hard coal equivalent (tce) could be saved up to 1985, i.e. 5% to 10% of the original consumption of primary energy. Up to the year 2000 savings in the range of 15% to 20%, corresponding to 150 to 250 million tce, are feasible. However, it is still uncertain whether the savings that are technically feasible will be beneficial for the economy as a whole. Likewise, a comparison between the profitability of capital investments for increased energy production and the profitability of more efficient utilization of energy is difficult.

1.2 Estimates of the Consumption of Primary Energy

First calculations with three different scenarios resulted in figures for the consumption of primary energy between 690 and 990 million tce for the year 2000. Such values correspond to average annual growth rates between 2.5% and 3.9% for the period 1975 to 2000. The estimate considered by us to have the highest probability resulted in a consumption of primary energy of 790 million tce for the year 2000. Compared with prognoses drawn up before the so-called oil crisis, which arrived at figures of 1,000 million tce and more, our figures imply a notable slow down of the previous growth rates. On the average, the consumption of primary energy according to our investigations would grow by about 3% annually as against 4.6% in the period 1950 to 1973 (see Table 1).

Table 1. Development of the GNP and PEC 1975 to 2000.

| | Scenario | | |
|---|----------|------|------|
| | I | II | III |
| GNP (billions of dollars) | | | |
| 1975 | 225 | 225 | 225 |
| 1985 | 320 | 336 | 302 |
| 2000 | 497 | 600 | 438 |
| GNP/capita (thousands of dollars) | | | |
| 1975 | 3.7 | 3.7 | 3.7 |
| 1985 | 5.3 | 5.4 | 5.2 |
| 2000 | 8.2 | 9.6 | 7.7 |
| Primary Energy Consumption (million tonnes coal equivalent) | | | |
| 1975 | 376 | 376 | 376 |
| 1985 | 530 | 565 | 495 |
| 2000 | 790 | 990 | 690 |
| Primary Energy Consumption per capita (tonnes coal equivalent) | | | |
| 1975 | 6.1 | 6.1 | 6.1 |
| 1985 | 8.8 | 9.1 | 8.5 |
| 2000 | 13.2 | 15.8 | 12.2 |

2. Electricity Generation in the FRG

In order to determine the contributions of the individual energy sources, we investigated, besides the entire demand for primary energy, the demand for electricity. We arrived at the result that the growth rates of the demand for electricity should be lower than supposed prior to the "oil crisis." In accordance with the scenarios investigated, we found values between 5% and 6.5% per annum for the period 1973 to 2000 which are still considerably above those for the consumption of primary energy. In order to find out to what extent the individual energy sources will participate in covering the demand for electricity, we analyzed the situation of supply from the viewpoint of the Federal Republic of Germany for each individual energy source. We then found, corresponding to the alternatives investigated, the results shown in Table 2.

Table 2. Electricity generation in the FRG in the year 2000.

| (Scenario I) | | | |
|--------------|--------------------|---|-----------------------------------|
| | 1974 ¹⁾ | 2000 | |
| | TWh | Terawatt-hour (10 ¹² Kwh) | Million Tonnes Coal Equivalent |
| Nuclear | 12.1 | 650 | 200 |
| Lignite | 81.2 | 60 | 20 |
| Gas | 54.5 | 70 | 20 |
| Oil | 31.1 | 70 | 20 |
| Hard Coal | 96.5 | 400 | 125 |
| Other | 36.3 | 50 | 15 |
| Total | 311.7 | 1,300 | 400 |

¹⁾ Preliminary.

We foresee that nuclear energy will be the most important future energy source for electricity generation. However, the role of nuclear energy should not be over-estimated. We estimate nuclear energy will generate 50% of the electricity and 28% of the primary energy. Thus, more than 70% of the energy needed for primary energy consumption and 50% of the energy needed for the generation of electricity must come from conventional energy sources. As a whole, 1,300 Twh will be generated in the year 2000 from 400 million tce.

3. The Future Contributions of Individual Energy Sources

As for the conventional energy sources, natural gas will reach its maximum with about 100 million tce at the beginning of the nineties and then go back again to about eighty million tce by the year 2000 due to the lack of availability. As regards crude oil, its availability should also play an important part so that its consumption will have to be limited to certain sectors. Therefore, there will be wide possibilities of expansion for hard coal by the end of this century, with new technologies (gasification and liquefaction of coal for electricity generation as well as for the heat market) presumably gaining in importance (see Table 3).

Table 3. Contributions of energy sources to primary energy consumption (Scenario I).

| 10 ⁶ tce | 1974 actual | 1985 2000 Projections | |
|---------------------|----------------|--------------------------|------|
| | | 1985 | 2000 |
| Nuclear | 4.1 | 75 | 225 |
| Lignite | 35.2 | 36 | 35 |
| Gas | 46.5 | 95 | 80 |
| Oil | 188.3 | 222 | 264 |
| Hard Coal | 82.7 | 90 | 175 |
| Other | 9.0 | 12 | 15 |
| Total | 365.8 | 530 | 794 |

4. Model Calculations

According to the first results of our model calculations, it became evident that nuclear energy and hard coal should be the main stays of future energy supplies to the Federal Republic of Germany. Above all, these trends appear to be realistic since:

- the total energy demand will probably increase further;
- effects from saving energy should not be over-estimated, especially as regards their economic feasibility;
- new energy sources will not be able to render an important contribution up to the year 2000;
- nuclear energy has a wide potential of development, although it has considerable problems;
- hard coal still has large reserves; and
- crude oil and especially natural gas will be available only to a limited extent.

Discussion

Hamilton

Points of interest to me were the estimates of energy savings for France, the FRG, and Japan, and through the discussion it might be interesting to investigate the differences between these various estimates. For example, in the paper by Morin it was suggested that the possible reduction in demand by 1985 compared with previous forecasts was in the range of 15% to 25%, and I think that elsewhere in the paper the range of 20% to 25% was suggested. But in the paper on the FRG, the comparable figure, at least I think it is comparable, was somewhat less, 5% to 10% of consumption of primary energy in 1985, and I got the impression from Hoffmann's comments that was considered to be a technical possibility. It would be interesting to investigate the difference between the two countries.

On the same point, in the case of energy demand in Japan, the little bit that I could pick up from the presentation was that the estimates of total primary energy consumption for 1980 and 1985 were somewhat higher than some estimates that were made at the OECD, but I could not yet calculate how much reduction that involves compared with previous growth.

I was very interested in the paper by Finon. I myself have a great deal of sympathy with such a linear programming approach. As he pointed out, it is a normative approach and it can yield estimates, independent of econometric approaches, of the possibilities for economizing on energy in the future. I think it would be most interesting to see the estimates that would emerge from this particular approach and compare them with estimates from econometric approaches.

Finally I have a few comments on the paper by Tintner and Wörgötter. The basic comment I have here is I think that equations of this sort do not yield very good estimates of the overall

reduction in energy consumption as opposed to the substitution of one form of energy for another. Just to give an example, I noticed in a couple of equations, in particular for coal, that the cross-elasticity coefficients were greater than the own price coefficients. This would suggest that if you have a 10% increase in the price of both coal and oil that you would end up with an increase in total energy consumption rather than a reduction. I would question whether this is plausible. A way to avoid this dilemma--following a suggestion made by Waverman and used in his own work--is to estimate the equations for different fuels simultaneously so that the cross-elasticity coefficients in the different equations are consistent with each other.

Taylor

Let me direct a question especially to the French and British representatives: In the United States there is at present a great deal of interest in peak-load pricing, and we are interested in knowing how households respond to differential prices at different hours of the day. Do the French or English have anything on the price elasticity of household demand for electricity at different hours of the day?

3.3 North America and Others

Residential, Commercial and Industrial Demand
For Energy in Canada:
Projections to 1985 With Three Alternative Models

M. Fuss, R. Hyndman, and L. Waverman¹

1. Introduction

The effect of relative prices on the demand for energy has not often been taken into account in projections of future energy requirements. The usual procedure is either to extrapolate past trends or to assume fixed proportions between energy and some measure of extrapolated output or income. A notable exception is the work of Hudson and Jorgenson [11] in their projections for the United States to the year 2000.

How important is the exclusion of relative price effects? In order to analyse this problem we present three alternative projections to 1985 of energy demand for the Canadian residential, commercial and industrial sectors. The first two projections correspond to the "naive" extrapolation methods outlined above. The third projection is computed from demand models incorporating the essential elements of microeconomic demand theory (hereafter called the micro-demand models), which were estimated by the authors (see Fuss et al. [8]) for Canada. Regional data for the years 1960-71 were used in a pooled time-series cross-section econometric estimate procedure. These micro demand models incorporate the relative price effects required for the comparative simulations.

¹This paper summarizes and extends a study (see Fuss et al. [8]) undertaken for the Federal Canadian Department of Energy, Mines and Resources. The views expressed here are not necessarily the views of this Department. Any errors or omissions are the fault of the three authors.

In Section 2, discussions of the energy data base in Canada and an outline of the changing patterns of energy use during the years 1958-71 are presented. Section 3 contains a summary of the models used in the projections. Section 4 summarizes the estimated structures of the micro-demand models and Section 5, the price and substitution elasticities derived from this structure. In Section 6 the projections are compared and evaluated.

2. Data Base and Patterns of Use

2.1 Data Base

A consistent set of data on Canadian energy consumption is available only for the period 1958-1971 (see [14]). With such a short time period, aggregate economy-wide estimates could not be made and a regional cross section/time series model was used. These data, although internally consistent, are subject to a number of limitations, the most important of which are outlined in this section.

Separate models for residential, commercial and industrial sectors were derived since each of these sectors were expected to contain a relatively homogeneous population with respect to energy use. However, Canadian energy consumption data is collected on the basis of "rate" category rather than ultimate use. Therefore, individual households are "residential" users under this rate-category definition, and so are small commercial and industrial customers. Large multiple residential dwellings on single meters (gas or electricity) fall under the commercial rate category, as do medium-sized commercial concerns (banking, insurance, real estate, real and wholesale trade, office buildings), government buildings, and urban transit systems. Clearly, this method of collection plays havoc with the conventional microeconomic definitions of end use. It is particularly serious with respect to the model for commercial demand. The industrial sector is represented in this paper by manufacturing. For manufacturing, the above problem does not exist since energy

consumption can be obtained from the General Review of Manufacturers [15]. While this eliminates the problems of rate classification, only purchased fuel is included and corrections must be made for fuel produced on site (own generation of electricity, for example).

Many of the prices used were implicit prices, the average cost per energy unit, obtained by dividing total sectoral expenditure on a particular fuel by total quantity consumed. In theory, when declining rate schedules or quantity discounts exist, the marginal price in the market is the appropriate price. Implicit prices are calculated from a mixture of spot purchases and long term purchases and may bear little resemblance to marginal prices.

In the cases of two fuels--natural gas and electricity--the purchaser faces a downward sloping average price schedule. The combination of both a commodity (fixed) charge and a running charge results in average price falling as use rises. It is not necessarily true that the fall in the average price induced the increase in consumption. For residential users the rate schedules for most electric and natural gas utilities have been collected in order to estimate marginal prices (or average prices for a specific volume).

2.2 Patterns of Consumption

Tables 1 and 2 detail the changing pattern of energy demand experienced in Canada in the short period of thirteen years (1958 to 1971).

2.2.1 The Distribution of Energy Types Between Sectors

From Table 1, it is evident that in this period, coal use has shifted from the rail and domestic markets to the industrial market. Since total coal BTU's (coal, coke and coke over gas) fell absolutely by 47%, the shift in use reflects a smaller decrease in the industrial market than in other markets.

Table 1. Distribution of a fuel among end uses, Canada 1958-1971.
(Percentages)

| | Coal | | Oil Products | | Natural Gas | | Electricity | | Total BTU's | |
|--------------------------|------|------|--------------|------|-------------|------|-------------|------|-------------|------|
| | 1958 | 1971 | 1958 | 1971 | 1958 | 1971 | 1958 | 1971 | 1958 | 1971 |
| Energy Supply Industries | .08 | .07 | 8.3 | 2.3 | 14.6 | 22.7 | 9.5 | 8.7 | 7.3 | 10.8 |
| Trans - Road | ---- | ---- | 34.3 | 33.7 | ---- | ---- | ---- | ---- | 19.6 | 19.1 |
| - Rail | 11.1 | 2.2 | 5.4 | 3.1 | ---- | ---- | ---- | ---- | 5.0 | 1.8 |
| - Air | ---- | ---- | 2.8 | 3.5 | ---- | ---- | ---- | ---- | 1.6 | 2.0 |
| - Marine | 2.2 | 4.8 | 4.3 | 3.6 | ---- | ---- | ---- | ---- | 2.9 | 2.1 |
| Domestic & Farm | 27.2 | 13.2 | 30.0 | 22.4 | 37.7 | 21.0 | 18.5 | 21.9 | 25.3 | 21.1 |
| Commercial | 9.1 | 9.8 | 5.0 | 12.1 | 18.1 | 18.4 | 11.3 | 22.5 | 7.4 | 14.7 |
| Industrial | 49.6 | 69.3 | 12.9 | 14.6 | 30.0 | 37.8 | 60.0 | 47.0 | 30.3 | 28.4 |
| TOTAL | 100 | 100 | 100 | 100 | 100 | 100 | 100 | 100 | 100 | 100 |

Net of losses and adjustments and non-energy uses.

Source: Statistics Canada [14].

Note: Columns may not add to total due to rounding.

Table 2. Importance of alternative fuels in each end use, Canada 1958-1971.

| | Energy Supply Industries | | Transportation | | | | | | | | | Domestic & Farm | | | Commercial | | Industrial | | | |
|---------------------|--------------------------|------|----------------|------|------|------|------|------|------|------|------|-----------------|------|------|------------|------|------------|------|------|------|
| | | | Road | | | Rail | | | Air | | | Marine | | | | | | | | |
| | 1958 | 1971 | 1958 | 1971 | 1958 | 1971 | 1958 | 1971 | 1958 | 1971 | 1958 | 1971 | 1958 | 1971 | 1958 | 1971 | 1958 | 1971 | 1958 | 1971 |
| Coal & Coke | 2.0 | ---- | ---- | ---- | 38.6 | 2.0 | ---- | ---- | 13.3 | 3.6 | 19.6 | 1.0 | 21.7 | 1.1 | 42.1 | 15.5 | | | | |
| LPG | 0.5 | 0.5 | ---- | ---- | ---- | ---- | ---- | ---- | ---- | ---- | 1.5 | 5.0 | ---- | ---- | ---- | 0.5 | | | | |
| Crude Oil | 3.5 | 1.2 | ---- | ---- | ---- | ---- | ---- | ---- | ---- | ---- | ---- | ---- | ---- | ---- | ---- | ---- | | | | |
| Still Gas | 28.4 | 17.8 | ---- | ---- | ---- | ---- | ---- | ---- | ---- | ---- | ---- | ---- | ---- | ---- | ---- | ---- | | | | |
| Motor Gasoline | 0.7 | 0.2 | 97.0 | 94.9 | ---- | ---- | ---- | ---- | ---- | ---- | ---- | ---- | ---- | ---- | ---- | ---- | | | | |
| Kerosene | ---- | ---- | ---- | ---- | ---- | 1.5 | ---- | ---- | ---- | ---- | 12.5 | 7.5 | 3.3 | 1.5 | 0.5 | 1.2 | | | | |
| Diesel Fuel Oil | ---- | 0.4 | 3.0 | 5.1 | 40.6 | 83.8 | ---- | ---- | 21.9 | 33.2 | 2.3 | 3.4 | 4.0 | 2.7 | 5.4 | | | | | |
| Light Fuel Oil | ---- | ---- | ---- | ---- | 0.9 | 2.3 | ---- | ---- | ---- | 0.5 | 40.6 | 41.1 | 12.5 | 14.3 | 2.8 | 4.2 | | | | |
| Heavy Fuel Oil | 26.5 | 17.3 | ---- | ---- | 19.6 | 10.3 | ---- | ---- | 64.0 | 63.7 | 1.9 | 3.3 | 18.6 | 28.2 | 18.2 | 17.4 | | | | |
| Petroleum Coke | 4.9 | 0.3 | ---- | ---- | ---- | ---- | ---- | ---- | ---- | ---- | ---- | ---- | ---- | ---- | ---- | ---- | | | | |
| Aviation Gasoline | ---- | ---- | ---- | ---- | ---- | ---- | 45.3 | 7.2 | ---- | ---- | ---- | ---- | ---- | ---- | ---- | ---- | | | | |
| Aviation Turbo Fuel | ---- | ---- | ---- | ---- | ---- | ---- | 54.7 | 92.8 | ---- | ---- | ---- | ---- | ---- | ---- | ---- | ---- | | | | |
| Natural Gas | 16.4 | 50.4 | ---- | ---- | ---- | ---- | ---- | ---- | ---- | ---- | 12.4 | 23.8 | 20.4 | 30.0 | 8.2 | 31.9 | | | | |
| Electricity | 16.4 | 11.6 | ---- | ---- | ---- | ---- | ---- | ---- | ---- | ---- | 9.2 | 15.0 | 19.4 | 22.2 | 25.3 | 24.0 | | | | |
| TOTAL | 100 | 100 | 100 | 100 | 100 | 100 | 100 | 100 | 100 | 100 | 100 | 100 | 100 | 100 | 100 | 100 | 100 | 100 | 100 | 100 |

Source: Statistics Canada [14].

Note: Columns may not add due to rounding.

The major change in oil products use is its declining importance in the residential sector, and increasing importance in the commercial sector (again, reflecting, in part, the classification of multiple residence use to the commercial sector).

As a percentage of total natural gas consumed, the residential sector use falls from 37.7% in 1958 to 21% in 1971. This shift corresponds partially to the shift in gas supply. In 1958, natural gas was mainly consumed in the two western provinces, achieving a very high penetration rate in the residential market. As gas supply was made available in eastern Canada after 1960, the residential market became a relatively less important market, reflecting the concentration of industry in the east.

Within the electricity market, the residential sector use increased from 18.5% in 1958 to 22% in 1971, primarily due to increased use of electrical appliances. For the commercial sector the doubling of its importance in the electricity market (from 11.3% to 22.5%) in thirteen years is a result of substantial growth in apartment and office space.

2.2.2 The Distribution of Energy Types Within a Sector

Coal represented only 1% of residential BTU consumption in 1971 as compared to nearly 20% in 1958. The natural gas share almost doubled over the period to nearly 24% partially due to service extensions to eastern Canada. The relative constancy of the oil share in the residential market for 1958 and 1971 masks substantial changes in market share for particular oil products. Kerosene's share of residential fuel market dropped by five percentage points while each of the other three oil products increased its share by several percentage points. The share of electricity in the residential sector increased from 9% to 15%. Electric heating was still a minor share of the home heating market in 1971; thus, as indicated above, the increase in electricity use came about through the increased use of electric appliances.

Within the commercial sector, the decrease in coal use was substantial; it dropped from 21.7% of the sector's total BTU consumption in 1958 to 1.1% in 1971. This market share was captured mainly by the two fossil fuels. The natural gas share increased by 50% and the oil and oil products share by 22%.

The major share changes between 1958 and 1971 in the industrial sector occurred in coal and natural gas. The former's share fell from 42.1% of the market to 15.5%; the latter's share correspondingly increased from 18.2% to 31.9% of industrial fuel use. There were slight increases in the share of oil products in this period, and a small decrease in the electricity share.²

3. The Models

3.1 Micro Demand Models

Two models which utilize the postulates of micro-economic demand theory were used to estimate the price responsiveness of energy demand. These models (the translog and logit specifications) are outlined in the following sections.

3.1.1 The Translog³

For the industrial sector, a modified translog model was estimated. We assume that a production function exists of the form

$$Q = F(E, L, M, K) \quad (1)$$

²This decrease is largely a statistical artifact. The data referred to in the table include only purchased electricity, excluding the own generator of electricity by industrial customers. In the estimation of our micro demand model a number of corrections are made to include own electricity generation.

³This section is a condensed summary of the concepts underlying our application of the translog model. For a detailed derivation of these concepts see FUSSELL [7].

where

Q = gross output,
 E = energy input,
 L = labour input,
 M = materials input, and
 K = capital input.

If we assume cost minimizing behaviour and exogenous factor prices and output levels, the theory of duality implies that there exists a unique representation of the underlying technology in the form of a cost function.

$$C = g(p_E, p_L, p_M, p_K, Q) \quad (2)$$

where C is total cost and p_i is the factor price (see Diewart [5]).

A translog function which provides a second order approximation to (2) and does not impose homotheticity on the production structure is

$$\begin{aligned} \log C = & \alpha_0 + \sum \alpha_i \ln p_i + \alpha_Q \ln Q + \sum_i \sum_j \gamma_{ij} \ln p_i \ln p_j \\ & + \sum_i \gamma_{iQ} \ln Q \ln p_i + \gamma_{QQ} (\ln Q)^2 \quad . \quad (3) \end{aligned}$$

Cost minimization with optimization errors implies

$$S_{ijt} = \alpha_i + \sum_k \gamma_{kj} \ln p_{kjt} + \gamma_{iQ} \ln Q_{ijt} + u_{ijt} \quad (4)$$

where i indexes the factor of production, j indexes the region and t indexes time. S_{ijt} is the cost share of the ith factor in the total cost of production.

Imposition of the adding up criterion and the properties of neoclassical production theory leads to the following constraints being imposed on the system of equation (4).

$$\left. \begin{aligned}
 \sum_i \gamma_{ij} &= 0 \\
 \sum_i \gamma_{iQ} &= 0 \\
 \sum_i \alpha_i &= 1
 \end{aligned} \right\} \text{(adding up)} \tag{5}$$

$$\begin{aligned}
 \sum_j \gamma_{ij} &= 0 && \text{(zero homogeneity in prices)} \\
 \gamma_{ij} &= \gamma_{ji} && i \neq j \text{ (symmetry)}
 \end{aligned}$$

The error term (u_{ijt}) in (4) is not likely to be randomly distributed. We hypothesize that it consists of two additive components: λ_{ij} which is constant over time but differs between regions and fuels, and ε_{ijt} which is random with zero expectation. In addition, we assume that error terms from different factor demand equations are uncorrelated, that is,

$$\begin{aligned}
 E(u_{ijt})^2 &= E(\varepsilon_{ijt})^2 = \sigma_{ii} && \text{when } i = j \\
 &= 0 && \text{when } i \neq j
 \end{aligned} \tag{6}$$

Equation (4) then takes the form:

$$S_{ijt} = (\alpha_i + \lambda_{ij}) + \sum_K \gamma_{Kj} \ln p_{Kjt} + \gamma_{iQ} \ln Q_{ijt} + \varepsilon_{ijt} \tag{7}$$

which is estimated by generalized least squares (to correct for heteroskedasticity) with individual factor, region constant terms.

Equation (7), estimated subject to (5) and (6), provides the demand structure for the four aggregate inputs: capital, labour, materials and energy (the KLEM model).

In addition, a subaggregate energy model is developed (to provide the demand structure for individual energy types) in the following way. Assume that (1) is weakly homogeneously separable into

$$Q = Q[E(E_1, \dots, E_N), L, M, K] \quad (8)$$

where E_i is the i th energy type. Then

$$C = C[p_E(p_{E_1}, \dots, p_{E_N}), p_L, p_K, Q] \quad (9)$$

p_E can be replaced by an aggregator index (\hat{p}_E) obtained from:

$$\ln p_E = \beta_0 + \sum_i \beta_i \ln p_{E_i} + \sum_i \sum_j \beta_{ij} \ln p_{E_i} \ln p_{E_j} \quad (10)$$

where (10) is a unit cost function of the translog form. The parameters of (10) can be estimated up to an arbitrary scaling factor β_0 from the share equations

$$s_{E_i} = \beta_i + \sum_j \beta_{ij} \ln p_{E_j} \quad (11)$$

subject to

$$\begin{aligned} \sum_i \beta_i &= 1 \\ \sum_j \beta_{ij} &= 0 \\ \beta_{ij} &= \beta_{ji} \end{aligned}$$

Substituting parameter estimates from (11) into (10) yields \hat{p}_E which is used as an instrumental variable in (7).⁴ The

⁴For a derivation and justification of the use of this translog aggregate price index, see Fuss [7].

estimate of the system of equations (11) provides a means of obtaining the price responsiveness of the demand for individual energy types.

3.1.2 The Logit Model

In the residential and commercial sectors, the inability to estimate the complete two-stage translog model led to the use of a simpler alternative--the logit model. The simple logit has the diminishing marginal rate of substitution property, that is, it is progressively more difficult for an energy type to capture all the market or be driven completely from the market (as compared to a linear or log-linear relationship). The model is defined as follows.

Let L_i be the share of BTU's of fuel i relative to total BTU's. The logit model can be written as:

$$\ln\left(\frac{L_i}{1-L_i}\right) = C_0 + C_1 P_i / P_j^* + C_2 Q \quad (12)$$

where

P_j^* = BTU weighted price of substitutes, and

Q = real measure of output of the sector.

3.2 Naive Demand Models

3.2.1 Time Trend Extrapolation

One method of forecasting is to fit a time-trend to the past and project that future growth will continue at past rates. For each sector, various time trends were estimated and used for forecasting.

3.2.2 Energy/Output Ratios

Another common method of projection is the use of average historical energy/output ratios to forecast energy consumption. Within each sector, equations for energy types E_h are estimated in the form:

$$E_{hit} = a_i + bQ_{it} \quad (13)$$

where a_i are individual regional constants and Q is a measure of real output in the sector.

4. Estimated Equations

4.1 Observations on Statistical Estimation of Demand Functions

The general trends in energy use discussed in Section 2 provide a background to the estimates of demand functions. Within any one sector, substantial shifts in the market shares of specific fuels have occurred. We would not expect that all these shifts were due to changes in relative prices. The drastic fall in coal's importance in every market is not solely due to the fact that the relative price of coal to other fuels was increasing. Many aspects of coal--its expense in handling, storage, cleanliness--are not captured entirely in the price per ton.

The growth in natural gas markets in eastern Canada is due to changes in supply conditions. In estimating demand functions for natural gas we assumed that natural gas customers could purchase all the gas they wanted at the market price. Supply restrictions in eastern Canada during the early years of our sample period renders this assumption somewhat untenable. Ideal estimates would have involved demand functions per serviceable customer--the number of potential customers within reasonable proximity of a gas line. Data on this population measure was unobtainable. For the residential sector a variable constructed from miles of distribution pipeline was used as a proxy for supply restrictions.⁵

⁵The surrogate for availability of gas in each region was constructed using data on miles of distribution pipeline of less than six inches in diameter, and urbanization within the region.

The period investigated--1958 to 1971--was one of relatively unchanging nominal prices and slowly falling real prices of energy. Without exception for every one of the fuels, the 1971 real price, in every sector, in every region, was below the 1958 value. The overall consumer price index rose in every region between 1958 and 1971. The period saw large increases in real output in all sectors and in real disposable income per capita. It is therefore not difficult to run a regression of energy as a dependent variable on the independent variables of price and income (output) and find strongly significant elasticities of the expected signs. The possibility of simultaneous equations bias is substantial.

Only in the industrial sector do we have independent estimates with which to compare our micro-demand models. In this sector, for the chemical industry the coefficients estimated statistically were compared with engineering estimates of interfuel substitution for the actual processes involved. While these analyses of processes were relatively rudimentary, they did indicate a range of factor substitutability corresponding to the econometric results. This is indicative of the fact that, at least in that sector, our estimated functions reasonably represent demand schedules.

4.2 The Manufacturing Sector

The model described in Section 3.1.1 was estimated for total Canadian manufacturing. Four regions were included in the combined time series--cross section data set: Quebec, Ontario, the Prairies and British Columbia and the Yukon. The Maritimes region was excluded due to the lack of appropriate data on natural gas. The time period used was 1961-1971. Inputs into the production process were specified to be labour, capital, materials and the energy types--coal, liquid

petroleum gas, fuel oil, natural gas, electricity and motor gasoline.⁶

4.1.1 The Inter-fuel Substitution Model

The energy submodel provides empirical estimates of the parameters of an aggregator function for the six energy types and an aggregate price index for "total energy" consistent with the underlying technological constraints on inter-fuel substitution.

The estimated equations presented in Table 4 are based on the imposition of the restriction that motor gasoline is not substitutable for other energy components.⁷ The notation is as follows (see next page):

⁶For all three sectors, we allowed for the difference among energy types in the efficiency of machines in converting energy inputs into outputs of heat, work, etc. Energy consumption was measured in terms of output BTU's defined to be consumption in BTU's of energy (input BTU's) multiplied by the utilization efficiency factor in Table 3 below. Prices were converted to output BTU terms by dividing by the appropriate efficiency factor.

Table 3. Utilization efficiency factors.

| | Residential | Commercial | Industrial |
|----------------|-------------|------------|------------|
| Coal | -- | 65 | 87 |
| LPG | 75 | 78 | 85 |
| Still Gas | -- | -- | 85 |
| Kerosene | 55 | 82 | 82 |
| Diesel Oil | 23 | 23 | 26 |
| Light Fuel Oil | 65 | 82 | 82 |
| Heavy Fuel Oil | 80 | 80 | 87 |
| Motor Gasoline | -- | -- | 20 |
| Natural Gas | 75 | 78 | 85 |
| Electricity | 100 | 100 | 100 |

Source: Discussions with personnel at Canadian Combustion Research Laboratories, and Energy, Mines and Resources, Ottawa.

⁷This hypothesis was tested and was not contradicted by the data at conventional significance levels (see Fuss [7]).

SCOAL = share of coal in total cost,
 SLPG = share of liquid petroleum gas,
 SFOIL = share of fuel oil,
 SNG = share of natural gas,
 SELEC = share of electricity,
 SGAS = share of motor gasoline,

 PCOAL = price of coal (thousands of dollars per
 10^6 BTU's),
 PLPG = price of liquid petroleum gas,
 PFOIL = price of fuel oil,
 PNG = price of natural gas,
 PELEC = price of electricity,
 PGAS = price of motor gasoline,

 QUE = dummy variable for Quebec,
 ONT = dummy variable for Ontario,
 PR = dummy variable for Prairies,
 BC = dummy variable for B.C. and Yukon.

Table 4. Manufacturing sector inter-fuel substitution model: estimated equations.

$$\begin{aligned}
 \text{SCOAL} = & .075 \text{ QUE} + .133 \text{ ONT} + .125 \text{ PR} + .050 \text{ BC} \\
 & (.022) \quad (.028) \quad (.032) \quad (.021) \\
 & - .104 \log (\text{PCOAL}) + .00347 \log (\text{PLPG}) \\
 & \quad \quad \quad (.0017) \\
 & + .0201 \log (\text{PFOIL}) + .0873 \log (\text{PNG}) \\
 & \quad (.014) \quad \quad \quad (.017) \\
 & - .00183 \log (\text{PELEC}) - .00502 \log (\text{PGAS}) \\
 & \quad (.017)
 \end{aligned}$$

(14)

Table 4. (continued)

$$\begin{aligned}
 \text{SLPG} &= .017 \text{ QUE} + .016 \text{ ONT} + .017 \text{ PR} + .014 \text{ BC} \\
 &\quad (.003) \quad (.004) \quad (.004) \quad (.003) \\
 &+ .00347 \log (\text{PCOAL}) - .00820 \log (\text{PLPG}) \\
 &\quad (.0017) \\
 &- .000680 \log (\text{PFOIL}) + .00446 \log (\text{PNG}) \\
 &\quad (.0023) \quad (.0017) \\
 &+ .00134 \log (\text{PELEC}) - .000385 \log (\text{PGAS}) \\
 &\quad (.0027) \quad (15) \\
 \\
 \text{SFOIL} &= .132 \text{ QUE} + .099 \text{ ONT} + .018 \text{ PR} + .105 \text{ BC} \\
 &\quad (.025) \quad (.030) \quad (.033) \quad (.024) \\
 &+ .0201 \log (\text{PCOAL}) - .000680 \log (\text{PLPG}) \\
 &\quad (.014) \quad (.0023) \\
 &- .0657 \log (\text{PFOIL}) + .0106 \log (\text{PNG}) \\
 &\quad (.015) \\
 &+ .0436 \log (\text{PELEC}) - .00782 \log (\text{PGAS}) \\
 &\quad (.0195) \quad (16) \\
 \\
 \text{SNG} &= .095 \text{ QUE} + .270 \text{ ONT} + .344 \text{ PR} + .122 \text{ BC} \\
 &\quad (.022) \quad (.026) \quad (.038) \quad (.022) \\
 &+ .0873 \log (\text{PCOAL}) + .00446 \log (\text{PLPG}) \\
 &\quad (.017) \quad (.0017) \\
 &+ .0106 \log (\text{PFOIL}) - .0260 \log (\text{PNG}) \\
 &\quad (.015) \\
 &- .0648 \log (\text{PELEC}) - .0116 \log (\text{PGAS}) \\
 &\quad (.017) \quad (17) \\
 \\
 \text{SELEC} &= .635 \text{ QUE} + .414 \text{ ONT} + .394 \text{ PR} + .666 \text{ BC} \\
 &\quad (.034) \quad (.041) \quad (.047) \quad (.032) \\
 &- .00183 \log (\text{PCOAL}) + .00134 \log (\text{PLPG}) \\
 &\quad (.017) \quad (.0027) \\
 &+ .0436 \log (\text{PFOIL}) - .0648 \log (\text{PNG}) \\
 &\quad (.0195) \quad (.017) \\
 &+ .0565 \log (\text{PELEC}) - .0349 \log (\text{PGAS}) \\
 &\quad (18) \\
 \\
 \text{SGAS} &= .046 \text{ QUE} + .068 \text{ ONT} + .103 \text{ PR} + .042 \text{ BC} \\
 &- .00502 \log (\text{PCOAL}) - .000385 \log (\text{PLPG}) \\
 &- .00782 \log (\text{PFOIL}) - .0116 \log (\text{PNG}) \\
 &- .0349 \log (\text{PELEC}) + .0597 \log (\text{PGAS}) \\
 &\quad (19)
 \end{aligned}$$

Note to Table 4:

The numbers in parentheses are standard errors. The coefficient estimates without standard errors are not obtained from the regressions but rather from the restrictions imposed by homogeneity of degree zero in prices of the demand functions by the adding up constraint, and by the assumed zero cross-elasticities of demand between motor gasoline and other energy components.

For example, consider the coal equation. Suppose we index the energy components by $i, j = 1, \dots, 6$ in the following order: coal, LPG, fuel oil, natural gas, electricity and motor gasoline. Then $\beta_{16} = -\text{SCOAL} \cdot \text{SGAS}$ from the cross elasticities restriction and $\beta_{11} = -\sum_{j \neq 1} \beta_{1j}$ from the zero homogeneity restriction.

Therefore β_{ii} and β_{i6} can be obtained without being included as regression coefficients. It should also be noted that β_{ii} and β_{i6} are not constants but variables in this specification. The numbers which appear in the table are the mean values over the sample. Finally, the adding up constraints implies $\sum (\beta_i + \delta_{ij}) = 1$, so that $\beta_6 + \delta_{6j} = 1 - \sum_1^5 (\beta_i + \delta_{ij})$.

This provides a means of calculating the regional dummy variables for the motor gasoline equation.

4.1.2 The Total Input Model (KLEM)

The KLEM aggregate model provides empirical estimates of the parameters of the underlying production technology involving aggregate capital (K), labour (L), energy (E) and materials (M) (see Table 5). These estimates are obtained by estimating the system (7) subject to the constraints (5) and (6); replacing p_E by its instrumental variable \hat{p}_E , obtained from the energy submodel by replacing the parameters in equation (10) by their estimates. The notation is as follows:

S_E = share of energy in gross output,

S_L = share of labour,

S_M = share of materials,

S_K = share of capital,

P_E = instrumental variable for the price of energy,

P_L = price of labour services,

P_M = price of materials,

P_K = price of capital services, and

Q = gross output in constant dollars.

Table 5. Manufacturing sector total input model:
estimated equations.

$$\begin{aligned}
 S_E &= .161 \text{ QUE} + .155 \text{ ONT} + .142 \text{ PR} + .159 \text{ BC} \\
 &\quad (.056) \quad (.058) \quad (.052) \quad (.051) \\
 &\quad + .0107 \log \hat{P}_E + .00400 \log P_L - .0116 \log P_M \\
 &\quad \quad \quad (.00589) \quad (.0067) \\
 &\quad - .00311 \log P_K - .00882 \log Q \\
 &\quad \quad \quad (.00469) \quad (.00362)
 \end{aligned} \tag{20}$$

$$\begin{aligned}
 S_L &= .636 \text{ QUE} + .630 \text{ ONT} + .548 \text{ PR} + .577 \text{ BC} \\
 &\quad (.143) \quad (.147) \quad (.131) \quad (.130) \\
 &\quad + .00400 \log \hat{P}_E + .0749 \log P_L - .0696 \log P_M \\
 &\quad \quad \quad (.00589) \quad (.0141) \\
 &\quad - .0131 \log P_K - .0289 \log Q \\
 &\quad \quad \quad (.0148) \quad (.0093)
 \end{aligned} \tag{21}$$

$$\begin{aligned}
 S_M &= -.095 \text{ QUE} - .111 \text{ ONT} + .033 \text{ PR} - .022 \text{ BC} \\
 &\quad (.143) \quad (.147) \quad (.131) \quad (.130) \\
 &\quad - .0116 \log \hat{P}_E - .0696 \log P_L + .0581 \log P_M \\
 &\quad \quad \quad (.0067) \quad (.0141) \\
 &\quad + .0193 \log P_K + .0425 \log Q \\
 &\quad \quad \quad (.0124) \quad (.0094)
 \end{aligned} \tag{22}$$

$$\begin{aligned}
 S_K &= .298 \text{ QUE} + .326 \text{ ONT} + .278 \text{ PR} + .285 \text{ BC} \\
 &\quad - .00311 \log \hat{P}_E - .0131 \log P_L + .0193 \log P_M \\
 &\quad \quad \quad (.00469) \quad (.0148) \quad (.0124) \\
 &\quad - .0031 \log P_K - .00478 \log Q
 \end{aligned} \tag{23}$$

Note to Table 5:

The numbers in parentheses are standard errors. The coefficient estimates without standard errors are not obtained from the regressions but rather from the restrictions imposed by zero degree homogeneity in prices and the adding up criterion ($S_E + S_L + S_M + S_K = 1$).

4.2 Residential Demand

A complete model of residential demand for energy would analyze both static and dynamic aspects of the choices involved for each major energy-using service. In the case of maintaining dwelling heat, for example, the model would include both the choice among types of energy and that between heat produced by the heating system and degree of insulation of the dwelling. There would also be both the choice of dwelling temperature during the heating season, and the amount of warm housing space. Furthermore, the dynamic response by householders to changes in prices, incomes and tastes (through habit formation) would have to be modelled. Information on energy consumption for different purposes is not available, so that the model is applied to data aggregated over all uses within the household as well as over all households within a region.

Instead of deriving a model rigorously from consumer demand theory and aggregating over uses and households, we have used both the logit specification (outlined in Section 3) and inverse exponential demand functions which capture the aggregate response of households as producers and consumers of services to changes in prices and income. Since changes over the estimating period have been relatively small and smooth, use of a static model, which assumes adjustment takes place within one period (one year) can be justified. For larger more abrupt changes, a dynamic model would be more appropriate.

Two general cases were explored: one which presumes substitution takes place among three energy types: electricity, natural gas and oil; and a second which assumes no substitution between electricity and the fossil fuels. Since one model would

be appropriate for some household uses of energy and the other for other uses, each is misspecified for the aggregate of household uses. As the second yielded more plausible results it is presented here.

The model involves two stages:

- 1) Total energy consumption by households is divided into electricity and fossil fuels, each of which is hypothesized to depend on prices, income per household, weather conditions and the proportion that single family dwellings are of total dwellings (a proxy for size of dwelling and classification of energy sales).
- 2) The share of fossil fuel consumption accounted for by each of oil and natural gas is determined as a function of relative prices of oil and gas, the proportion that single family dwellings are of total dwellings, and the proxy variable for availability of natural gas.

Estimates

For estimates we have pooled the five regional time series for 1958-1971.⁸ For the share of equations of oil and gas, the Atlantic region is omitted and oil is assumed to capture the total market. The regression results are presented in Table 6 for electricity consumption per household (EH), the aggregate

⁸In estimates, coal has been excluded from all regions and natural gas excluded from the Atlantic region. Coal consumption by households has declined steadily in absolute terms during the period, to a negligible proportion of total energy consumed by households. That trend appears to be the result more of a dynamic response to conditions (prices and income) existing at the beginning of the period than to changing conditions during the period. Gas was excluded from the Atlantic region for three reasons: the nature of the market appeared different than in other regions (much less use for space heating); in the Atlantic, gas is a small proportion of total energy consumption by households; and gas is not available in most of the region outside New Brunswick. In the few cases where coal and Atlantic gas were included in regressions the empirical results were inferior.

Table 6. Residential equations: residential sector logit model.

$$\begin{aligned}
 \text{EH} &= 11.7 - .14 \text{ PE} - 1.25 \text{ IYH} - 1.16 \text{ IYHQ} - .56 \text{ SM} + .51 \text{ DDRN} + 1.30 \text{ DQ} + .08 \text{ DO} + .06 \text{ DP} + .07 \text{ DB} \\
 &\quad (24.1) \quad (-.97) \quad (-13.4) \quad (-6.77) \quad (-1.49) \quad (2.50) \quad (4.97) \quad (1.28) \quad (1.14) \quad (2.52) \\
 &\quad (24) \\
 \text{GPH} &= 9.73 - .73 \text{ PGO} - .79 \text{ IYH} + 2.21 \text{ SM} + .85 \text{ DDRN} + 1.07 \text{ DQ} + .17 \text{ DO} - .28 \text{ DP} - .43 \text{ DB} \\
 &\quad (25.3) \quad (3.48) \quad (-9.43) \quad (6.81) \quad (4.57) \quad (5.64) \quad (2.67) \quad (-4.18) \quad (-16.3) \\
 &\quad (25) \\
 \text{LS} &= -1.23 - 1.56 \text{ RPGO} + .51 \text{ PL} + 1.80 \text{ DO} + 1.87 \text{ DP} + 1.42 \text{ DB} \\
 &\quad (-3.628) \quad (-5.92) \quad (4.12) \quad (19.3) \quad (10.7) \quad (11.0) \\
 &\quad (26)
 \end{aligned}$$

EH (electricity per household) and GPH (gas plus petroleum per household) are in logarithm form.

LS is the logit of the share of gas.

The following independent variables are in linear form (deflated by their values for Ontario in 1971).

- PE - price of electricity
- IYH - inverse of personal disposable income per household
- IYHQ - IYH dummy for Quebec
- SM - single family dwellings as a proportion of total dwellings
- DDRN - heating degree days relative to normal
- DQ } - intercept dummies for Quebec, Ontario, the Prairies and B.C., respectively
- DO }
- DP }
- DB }
- PGO - aggregate price of gas and oil deflated by the Consumer Price Index using estimated shares as weights for aggregation
- RPGO - ratio of the price of gas to the price of oil
- PL - a variable representing availability of natural gas calculated using miles of distribution pipeline and urbanization.

of natural gas and petroleum products consumption per household (GPH) and the logit of the share of gas (LS).

Because residential users of electricity and natural gas face downward sloping price schedules, the average and often the marginal price paid by a consumer declines as the quantity purchased increases. There would thus be a simultaneity problem if we used average price paid to estimate demand. For this reason we used marginal prices taken from the price schedules.

4.3 Commercial Demand for Energy

This sector is an aggregation of heterogeneous users, with no available measure of capital and material inputs and no output measure different from the amount of labour inputs. Empirical work is considerably restricted. Total demand for energy in the five regions was obtained by estimating a linear demand function of the form

$$X_t = a_0 + a_1RT + a_2PB + a_3D_1 + a_4D_2 + a_5D_3 + a_6D_4$$

where

X_t = total demand for energy,

PB = average weighted price of energy,

RT = real retail trade.

D_1, D_2, D_3, D_4 are dummy variables for Quebec, Ontario, the Prairies and British Columbia respectively. The results of the estimation are reported in Table 7. To estimate the shares of the individual energy components the logit model was used. The logit model unlike the translog model does not incorporate any constraints which force the equality of relevant cross substitution terms or ensure that the shares of expenditures on the four fuels add up to unity. The equations are presented in Table 8. One additional variable, the single/multiple dwelling split proved significant in the oil equation.

Table 7. Commercial sector: aggregate energy regression results.
(t values in parentheses) 1961-71

$$X_t = -84.0 + 3.74 RT + -31.0 PB + 112.0 D_1 + 55.4 D_2 + 84.4 D_3 + 102.0 D_4 \bar{R}^2 \Delta W$$

| | | | | | | | | | |
|--------|-------|--|---------|-------|-------|-------|-------|------|------|
| (-1.5) | (7.3) | | (-2.25) | (3.8) | (4.7) | (3.6) | (4.7) | .914 | 1.58 |
|--------|-------|--|---------|-------|-------|-------|-------|------|------|

(27)

(elasticities at 1971 Ontario values: price = -.21, income = 1.48)

where

X_t = total BTU's (millions),

PB = average weighted price per BTU (\$/million BTU's),

RT = retail trade, hundreds of millions 1961 constant dollars.

Table 8. Commercial share equations:
logit model.

| | $X_{it} = a_0 + a_1 P_{ix}/P_{is} + a_2 Y_{it} + a_3 D_1 + a_4 D_2 + a_5 D_3 + a_6 D_4 + a_7 MS$ | | | | | | | \bar{R}^2 | SEE | DW |
|---------------------------|--|-------------------|-----------------|------------------|-----------------|---------------|----------------|----------------|------|-----------|
| Natural Gas ¹⁾ | -.66 (-3.0) | -1.509 (-6.2) | .009 (2.4) | -5.41 (-25.5) | -1.70 (-8.3) | 2.29 (5.5) | 1.82 (2.9) | ----- .9960 | .114 | 2) (28) |
| Oil | .901 (2.7) | -4.014 (-8.9) | .165 (3.4) | 1.08 (4.2) | .23 (1.5) | -.04 (-.2) | -.06 (-.2) | ----- .9741 | .183 | 1.42 (29) |
| Coal | .07 (.7) | -14.95 (-11.2) | -.051 (-4.5) | -(.29) (-1.5) | .51 (1.5) | 3 (4.9) | -.48 (-4.9) | ----- .991 | .332 | 2) (30) |
| Electricity | .89 (1.0) | -.081 (-2.9) | -.005 (-1.5) | -.49 (-3.2) | -.55 (-1.7) | .10 (.7) | .23 (1.5) | -2.0 (-1.8) | .105 | 1.62 (31) |

X_{it} : output BTU's, millions, percent t, province i,

P_x : price of fuel x, ¢/million BTU's,

P_s : price of aggregate substitutes for fuel x, ¢/million BTU's,

Y_i : real value of retail trade, province i,

D_i : intercept dummy, province i,

H_i : percentage of multiple dwellings in total dwellings.

1) t values in parentheses except 1962-1963 Atlantic provinces.

2) Estimated in Hildreth-Liu search to remove serial correlation.

3) Dropped to prevent singularity.

4.4 Naive Models

Estimating equations are not presented for the naive models. As expected, these simple models fit the data of the 1960's well, with highly significant R^2 and t statistics.

5. Estimated Elasticities

5.1 Manufacturing

In Table 9 we compare the own price elasticities of demand and the Allen-Uzawa elasticities of substitution for energy, labour, capital and materials. Three sources are used:

1) Berndt and Wood [2], a study of aggregate USA using a linear homogeneous translog production function; 2) Denny and Pinto [4], a study of aggregate Canada for 1949 to 1970 using a generalized (non-homothetic) Leontief production function; and 3) the results presented in this study using a modified translog on a cross section, time series basis for 1958 to 1971. The average energy price elasticity across Canada for the modified translog approach is $-.5$, close to the value obtained both from the aggregate Canadian and aggregate USA studies 1) and 2).

The elasticities of substitution as indicated in Table 9 present far greater differences than the price elasticities. Where both the US study 1) and the generalized Leontief 2) find complementarity between energy and capital, the translog 3) finds substitutability. While the magnitudes of the other elasticities of substitution differ, their signs consistently indicate substitution except for the materials and capital complementarity in 2).

In Table 10, we compare the price elasticities for specific fuels. Neither the ESC nor the DRI studies incorporate consistent systems of equations. Both the electricity and natural gas elasticities are lower in our study than in the other two studies; a reasonable result since both these fuels tend to have more specific uses than boiler fuel oil. In this study, all cross price elasticities are positive--indicating the substitutability of one fuel for another.

Table 9. Comparison of price elasticities and elasticities of substitution.
(Industrial Sector: Input Substitution)

| Own Price Elasticities of Demand | | | Source | | |
|---|------------|-------------|---------------|--|-------------------------|
| Energy (E) | Labour (L) | Capital (K) | Materials (M) | | |
| -.49 | -.45 | -.44 | -.24 | | (USA 1971) (1) |
| -.59 | -.77 | -.31 | -.05 | | (Canada 1970) (2) |
| -.36 | -.45 | -.79 | -.37 | | (Ontario 1971) (3) |
| Elasticities of Substitution | | | | | |
| | (1) | (2) | (3) | | |
| K-L | 1.01 | 5.46 | .72 | | |
| K-E | -3.22 | -11.91 | .42 | | |
| K-M | .56 | -0.99 | 1.17 | | |
| L-E | .64 | 4.89 | 1.70 | | |
| L-M | .60 | .43 | .46 | | |
| E-M | .74 | .12 | .17 | | |
| | (1965) | (1965) | | | (mean Canada 1961-1971) |
| Sources: | | | | | |
| 1) Berndt and Wood [2] (Aggregate USA - Translog). | | | | | |
| 2) Denny and Pinto [4] (Aggregate Canada - generalized Leontief). | | | | | |
| 3) This Study. | | | | | |

Table 10. Comparison of price elasticities: industrial sector.
(Inter-fuel Substitution)

| Own Price Elasticity | Cross Price Elasticities | | | | Source |
|-------------------------|--------------------------|-----|-------------|------|------------------------------|
| | Electricity | Oil | Natural Gas | Coal | |
| Electricity | | | | | |
| -1.02 | ---- | .12 | .15 | .18 | Erickson et al. [6] |
| -.79 | ---- | nc | nc | nc | DRI [3] |
| -.60 | ---- | .58 | .04 | .27 | This study (Ontario 1971) |
| Oil | | | | | |
| -.65 | .87 | --- | .90 | -.71 | Erickson et al. [6] |
| -1.32 | .20 | --- | .14 | .40 | This study (Ontario 1971) |
| Natural Gas | | | | | |
| -2.53 | .07 | .02 | --- | .01 | Erickson et al. [6] |
| -.94 | .02 | .23 | --- | 1.45 | This study (Ontario 1971) |
| Coal | | | | | |
| -2.51 | .04 | .18 | .40 | ---- | This study (Ontario 1971) |

nc - not considered

5.2 Residential Sector

Other studies have found own price elasticities for residential electricity demand to vary between $-.44$ and -1.33 (Table 11). This study, which has examined the substitutability between electricity and fossil fuels, has found a (Ontario 1971) price elasticity of $-.14$ for electricity. Given the use of electricity for lighting, cooking, etc., uses not rapidly reduced as price increases, the results presented in this paper appear plausible.

For fossil fuels, as inelastic price response on the part of residential users is found (Table 12). The estimate $-.73$ lies within the range found in other studies $-.13$ to -2.75 . This estimate does not include any effect of substitution between natural gas and petroleum products. For such substitution our estimate is $-.96$ for the elasticity of the share of natural gas, of gas and petroleum products combined, with respect to the price of gas relative to the price of oil.

5.3 Commercial Sector

For the commercial sector, only one previous study has been made--and that was limited to electricity use (Table 13). This previous estimate of an electricity own price elasticity of $-.94$ indicates easy response by commercial users to changes in electricity prices--a response which is unlikely. Commercial users cannot easily respond to changes in the price of electricity except by removing lights, lowering thermostats in winter and raising temperatures in summer. This study shows an average price elasticity in Canada for the 1960 to 1971 period of $-.31$, one third that found in the previous study.

6. Projection Results

6.1 Introduction and Data

In order to project consumption of energy variables to 1985 with two of the three models, projections of the independent variables are required (the time trend model uses no explanatory variables). Rates of change in personal disposable

Table 11. Comparison of price elasticities:
residential electricity.

| Own Price Elasticity | Cross Price Elasticities | Elasticities | | Source |
|-------------------------|-----------------------------|--------------|-----|------------------------|
| | | Natural Gas | Oil | |
| -1.12 | .30 | nc | .12 | Anderson [1] |
| -1.33 | .23 | nc | nc | Halvorsen [9] |
| -1.33 | .31 | nc | nc | Wilson [17] |
| -1.21 | .21 | nc | nc | Mount [13] |
| -.44 | nc | nc | nc | Houthakker et al. [10] |
| -.44 | nc | nc | nc | Data Resources [3] |
| -.14 | * | * | * | This study |

nc - not considered.

* - tests run on the substitutability of fossil fuels for electricity and zero substitutability found.

Table 12. Comparison of price elasticities:
residential oil and natural gas.

| Own Price Elasticity | Cross Price Elasticities | | | | Source |
|-------------------------|--------------------------|------|-------------|------|-------------------------|
| | Electricity | Oil | Natural Gas | Coal | |
| Natural Gas | | | | | |
| -2.75 | -.67 | -.25 | ---- | -.41 | Anderson [1] |
| -1.3 | nc | ** | ---- | nc | Watkins [16] Ontario |
| -.44 | nc | nc | ---- | nc | Data Resources [3] |
| Oil | | | | | |
| -1.58 | .21 | ---- | 2.1 | .08 | Anderson [1] |
| -.13 | nc | ---- | .41 | nc | Data Resources [3] |
| Fossil Fuels | | | | | |
| -.73 | * | ---- | ---- | nc | This study |
| Share Of Natural Gas | | | | | |
| -.96 | | | | | |

* - not substitutable with electricity.

** - has same value as dependent variable but of opposite sign.

nc - not considered.

Table 13. Comparison of price elasticities;
commercial sector.

| Own Price Elasticity | Cross Price Elasticities | | | | Source |
|-------------------------|--------------------------|-----|-------------|------|---------------|
| | Electricity | Oil | Natural Gas | Coal | |
| Electricity | | | | | |
| -.94 | ---- | nc | -.41 | nc | Halvorsen [9] |
| -.31 | ---- | * | * | * | This study |
| Oil | | | | | |
| -1.10 | * | * | ---- | * | This study |
| Natural Gas | | | | | |
| -.72 | * | * | ---- | * | This study |
| Coal | | | | | |
| -2.73 | * | * | ---- | ---- | This study |

* - The cross price elasticity for a weighted average price index of substitutes (weights are output BTU shares) has the same elasticity as the dependent fuel but with opposite sign.

nc - not considered.

income and real manufacturing output (taken to be the rate of change for the business non-agricultural sector), were forecast by using the time path predictions to 1985 for Canada that were generated by the University of Toronto's Annual Econometric Model of the Canadian Economy (TRACE). Real retail trade was projected by extrapolating exponential time trends for each region.

Forecasts of fuel prices were generated by the authors. Real Canadian crude oil prices are expected to move to world levels by 1977 and then parallel world movements. The real world oil price is expected to fall slowly to 1980. Oil product prices were assumed to increase at slightly greater rates than crude prices reflecting greater increases in transport costs, refinery margins and distribution costs. Natural gas prices were forecast as reaching commodity value with oil by 1978 and then moving to a slight premium. The real price of coal is expected to increase throughout the period, based on an analysis of mining and transporting coal to markets. Electricity prices were generated by estimating the incremental costs of new facilities in each region, for stated additions of thermal, hydro and nuclear capacity.

The service prices of other inputs into manufacturing were also obtained from projections of the TRACE model.⁹ Households were projected by assuming a constant 1971 household size and using the TRACE projections of population. Degree days were assumed to be normal throughout the projection period. The division of dwellings between single and multiple residences

⁹TRACE does not forecast the user cost of capital directly. However, it does forecast capital asset prices and interest rates. Assuming no change in depreciation rates and fiscal investment incentives during the forecast period, we can obtain the time path of the user cost by utilizing the available series. The price of the materials input is also not available directly. We have used the average rate of change of import and export material prices as our approximation to the time path of the materials price index.

was projected to change at past rates. The surrogate measure of potential residential natural gas customers was projected via a linear time trend. The results presented below are for Ontario only. The projections for other regions were similar qualitatively to those reported in this paper.

6.2 Manufacturing

6.2.1 Exogenous Variables Forecasts

The exogenous variables projections are presented in Table 14 for the selected years 1975, 1980, 1985. The most striking feature is the large projected increases in coal and electricity prices relative to other prices.¹⁰ It also appears from Table 14 that energy prices in general are forecast to rise more rapidly than the prices of the other aggregate inputs. (This fact is confirmed by the endogenous aggregate energy price index presented in Table 15.) Real output increases considerably more slowly than prices indicating that any substitution effects present will be important in determining the time paths of the variables.

6.2.2 Projection Procedures and Results

The endogenous variables are the quantities of the energy components; the aggregate quantities of energy, labour, materials and capital; the price of aggregate energy and the supply price of manufacturing output. Projections of these variables from the microdemand model were obtained by substituting the appropriate exogenous variables into equations (14)-(19) and (20)-(23).¹¹ In order to facilitate projection comparisons

¹⁰ Since the price of coal in Ontario has risen approximately 50% in the past year, and Ontario Hydro is currently claiming the need for a 30% increase in the price of electricity these projections do not appear to be unreasonable.

¹¹ The equations (14)-(19) take the form

$$S_{E_i} = \beta_i + \sum_{j \neq \text{GAS}} \beta_{ij} \cdot \ln p_{E_j} - S_{E_i} \cdot S_{\text{GAS}} \cdot \ln p_{\text{GAS}}, \quad i \neq \text{GAS} .$$

Therefore, they are non-linear in the unknown shares. Solution was accomplished by iteration to convergence. The supply price of output was obtained from an estimated inverse supply function not presented in this paper. For details of the estimation see Fuss [7].

Table 14. Exogenous variables: industrial (Ontario).

| Variable | Actual 1971 Value | Units | Projected Values Relative to 1971 (1971 = 1.00) | | |
|-------------------|-------------------|---------------------------------------|---|------|------|
| | | | 1975 | 1980 | 1985 |
| Price of: | | | | | |
| Coal | 0.76 | dollars per 10 ⁶ BTU's | 2.52 | 4.59 | 5.85 |
| LPG | 1.84 | \$ per 10 ⁶ BTU's | 1.67 | 2.91 | 3.33 |
| Fuel Oil | 0.63 | \$ per 10 ⁶ BTU's | 1.67 | 2.91 | 3.33 |
| Natural Gas | 0.56 | \$ per 10 ⁶ BTU's | 1.43 | 3.29 | 3.78 |
| Electricity | 2.50 | \$ per 10 ⁶ BTU's | 1.79 | 3.48 | 4.66 |
| Gasoline | 2.75 | \$ per 10 ⁶ BTU's | 1.67 | 2.91 | 3.33 |
| Labour | 3.77 | Dollars per man hour | 1.48 | 2.22 | 3.29 |
| Materials | 1.30 | Index (1962 = 1.0) | 1.71 | 2.24 | 2.92 |
| Capital | 1.55 | Index (1962 = 1.0) | 1.78 | 2.57 | 3.50 |
| Quantity of: | | | | | |
| Real Gross Output | 21.61 | Constant 10 ⁹ 1961 dollars | 1.28 | 1.74 | 2.23 |

Table 15. Endogenous variables industrial (Ontario).

| Variable | Actual 1971 Value | Units | Projected Values Relative to 1971 (1971 = 1.00) | | | | | | | | | | | |
|--------------------------------------|-------------------|---------------------------------------|---|--------|--------|--------|-------------------|--------|-------------------|-------------------|--------|--|--|--|
| | | | 1975 | | | 1980 | | | 1985 | | | | | |
| | | | (1) a) | (2) b) | (3) c) | (1) a) | (2) b) | (3) c) | (1) a) | (2) b) | (3) c) | | | |
| Coal | 41.5 | 10 ⁶ BTU's | .93 | .80 | .80 | .34 | .00 ^{e)} | .31 | .00 ^{e)} | .00 ^{e)} | .20 | | | |
| LPG | 1.9 | 10 ⁶ BTU's | 1.28 | 1.65 | 1.07 | 1.64 | 2.72 | 1.41 | 2.00 | 3.86 | 1.74 | | | |
| Fuel Oil | 113.1 | 10 ⁶ BTU's | 1.16 | 1.44 | 1.02 | 1.36 | 2.16 | 1.18 | 1.56 | 2.93 | 1.45 | | | |
| Natural Gas | 207.6 | 10 ⁶ BTU's | 1.09 | 1.30 | 1.26 | 1.20 | 1.80 | 1.03 | 1.31 | 2.33 | 1.19 | | | |
| Electricity | 87.2 | 10 ⁶ BTU's | 1.11 | 1.27 | .92 | 1.24 | 1.72 | .89 | 1.37 | 2.20 | .89 | | | |
| Gasoline | 9.9 | 10 ⁶ BTU's | 1.06 | 1.21 | 1.27 | 1.13 | 1.55 | 1.27 | 1.20 | 1.91 | 1.38 | | | |
| Aggregate Energy | 461.2 | 10 ⁶ BTU's | 1.08 | 1.22 | 1.03 | 1.17 | 1.58 | .98 | 1.26 | 1.97 | 1.12 | | | |
| Labour | 1.7 | 10 ⁹ man hours | d) | d) | 1.22 | d) | d) | 1.39 | d) | d) | 1.47 | | | |
| Materials | 10.9 | 1961 10 ⁹ Constant Dollars | d) | d) | 1.20 | d) | d) | 1.56 | d) | d) | 1.89 | | | |
| Capital | 4.0 | 1961 10 ⁹ Constant Dollars | d) | d) | 1.11 | d) | d) | 1.29 | d) | d) | 1.47 | | | |
| Price of Aggregate Energy | 1.26 | Index (1962 = 1.0) | d) | d) | 1.69 | d) | d) | 3.31 | d) | d) | 4.07 | | | |
| Supply Price of Manufacturing Output | 1.26 | Index (1962 = 1.0) | d) | d) | 1.54 | d) | d) | 1.94 | d) | d) | 2.37 | | | |

a) Naive time trend model.

b) Naive input-output model.

c) Micro-demand model.

d) Not calculated.

e) Negative value.

the intercept adjustment procedure was utilized to insure that the actual values and predicted values of the endogenous variables from all three models coincide in 1971.

The simulation results are presented in Table 15 and Figures 1-6. Figure 1 demonstrates the effect, as predicted by the microdemand model, of the increase in the price of energy relative to the prices of other factors. Demand for energy is approximately constant from 1972-76, drops sharply from 1976-79 in response to large price increases, and then increases from 1980-85. The most substantial increase is in the materials input. The net result at this aggregate level is consistent with a shift in manufacturing output away from energy intensive primary industries to materials intensive secondary industries.

From Figures 3-6 it is possible to compare the three alternative projections for the individual energy components. With the exception of coal and natural gas the microdemand model predicts a uniformly lower level of demand for energy components than the time trend and input-output models, reflecting "conservation" in the face of rising relative prices. The demand for coal is predicted to fall to low levels by all three models. The naive models predict zero demand before the end of the period.¹² The microdemand model predicts a substantial reduction--to 20% of the 1971 amount by 1985. The fact that the prediction is not zero is due to the diminishing marginal rate of substitution property of neoclassical production functions. The microdemand model predicts the highest level of natural gas use until 1975, when the large relative increases in the natural gas price to commodity value equivalence with crude oil leads to substitution away from natural gas towards fuel oil.

¹²This prediction is for coal used as a fuel. Coal used for the coking in steel production is included in the materials input.

The microdemand model provides predictions substantially different from the two naive models. Of most importance, the model predicts a decline in the energy intensity of production after 1975. With respect to individual energy types, moderate increases in the use of fuel oil and natural gas; a decline in the use of electricity, and a sharp decline in the use of coal are forecast for the 1975-85 period.

6.3 Residential

6.3.1 Exogenous Variables Forecasts

In nominal terms all prices rise throughout the period. In real terms the electricity price rises continually while oil and gas prices begin to fall after 1978. Relative to the price of oil, the price of gas first falls, then rises, and finally stays constant. The price of electricity rises relative to both oil and gas.

Real personal disposable income per household rises smoothly. By 1985 it has increased less than the real price of electricity but more than the real prices of oil and gas. The number of households increase smoothly. By 1985 this number increases to 20% above the 1971 level.

Single family dwellings as a proportion of total dwellings declines by about .005 per year. The proportion of the market serviced by gas increases smoothly from .45 to .75. Degree days relative to normal is set equal to one throughout the forecast period (see Tables 16 and 17 and Figures 7 to 10).

6.3.2 Projection Procedure and Results

The shares of oil and gas were projected by substituting forecast values for the exogenous variables in equation (26). These projected shares were then used to calculate the aggregate price of oil and gas. The consumption of oil and gas combined was forecast by substituting the values of aggregate price and the other exogenous variables into equation (25). Individual consumption of oil and gas is given by the relevant projected share times the projected energy aggregate. The

Table 16. Exogenous variables: residential (Ontario).

| Variable | Actual 1971 Value | Units | Projected values relative to 1971 (1971 = 1.00) | | |
|---|-------------------|--------------------------|---|------|------|
| | | | 1975 | 1980 | 1985 |
| Price of fuel oil | 1.34 | \$/10 ⁶ BTU's | 1.63 | 2.64 | 3.00 |
| Marginal price of natural gas | 1.15 | \$/10 ⁶ BTU's | 1.45 | 3.30 | 3.76 |
| Marginal price of electricity | 3.69 | \$/10 ⁶ BTU's | 1.79 | 3.50 | 4.68 |
| CPI | 1.00 | 1971 = 1.00 | 1.39 | 1.98 | 2.52 |
| Real personal disposable income per household | 10,871 | Constant 1971 dollars | 1.21 | 1.50 | 1.83 |
| No. of households | 2,228 | thousands | 1.06 | 1.13 | 1.20 |

Table 17. Endogenous variables: residential (Ontario).

| Variable | Actual Consumption in 1971 10^6 BTU's | Projected levels relative to 1971 (1971 = 1.00) | | | | | | | | |
|--------------------|--|---|------|------|------|------|------|------|------|------|
| | | 1975 | | | 1980 | | | 1985 | | |
| | | 1a) | 2b) | 3c) | 1a) | 2b) | 3c) | 1a) | 2b) | 3c) |
| Petroleum products | 197.1 | 1.14 | 1.31 | .65 | 1.33 | 1.80 | .60 | 1.54 | 2.39 | .72 |
| Natural gas | 105.1 | 1.24 | 1.59 | 1.16 | 1.56 | 2.52 | .79 | 1.92 | 3.65 | 1.10 |
| Electricity | 63.4 | 1.19 | 1.43 | 1.31 | 1.46 | 2.12 | 1.64 | 1.75 | 2.95 | 2.04 |
| Total | 365.6 | 1.18 | 1.41 | .91 | 1.42 | 2.06 | .84 | 1.69 | 2.85 | 1.06 |

a) Naive linear time trend

b) Naive consumption/income model

c) Micro-demand model.

forecast of electricity consumption is obtained by substituting the forecast values of exogenous variables in equation (24).

Total residential energy consumption in Ontario projected by the demand model declines below the 1971 level by 1975, declines further by 1980 and finally rises above the initial level by 1985. This pattern in total energy demand occurs because oil and gas decrease more than electricity increases. The relatively high price elasticity and the relatively low income elasticity for oil and gas result in price increase dominating income and population increases.

Changing prices affect the oil and gas projections in two ways: first by the effect on consumption of oil and gas combined and second, by the effect of changing relative prices on the shares of each in the combined consumption. The projected real price increases up to 1980 cause a reduction in combined consumption. The increase in the price of oil relative to the price of gas before 1980 causes the share of gas to increase. Projected increases in availability of gas also cause the share of gas to increase slightly after 1980 when relative prices of oil and gas are constant. For both oil and gas, the demand model projections are below the projections obtained from the two naive models.

In the case of electricity, the model projects a relatively smooth rise in consumption, above the linear time trend but below the income trend. The relatively low estimated price elasticity of demand results in the electricity price increases being dominated by the projected income and population increases.

6.4 Commercial

6.4.1 Exogenous Variables Forecasts

Table 18 presents the changes in exogenous variables for the commercial sector. Between 1972 and 1980, the price of natural gas is expected approximately to quadruple while the price of fuel oil triples, representing the substantial relative price change involved in obtaining commodity value for natural gas. By 1985, electricity prices have increased the most of all fuels.

Table 18. Exogenous variables: commercial (Ontario).

| Variable | Actual 1971 Value | Units | Projected Values: Relative to 1971 (1971 = 1.00) | | |
|----------------|-------------------|---------------------------------------|--|------|------|
| | | | 1975 | 1980 | 1985 |
| Price of: | | | | | |
| Coal | 1.17 | dollars per 10 ⁶ BTU's | 1.83 | 3.58 | 4.64 |
| Fuel Oil | 1.35 | dollars per 10 ⁶ BTU's | 1.89 | 3.19 | 3.73 |
| Natural Gas | 1.11 | dollars per 10 ⁶ BTU's | 1.64 | 3.84 | 4.49 |
| Electricity | 4.10 | dollars per 10 ⁶ BTU's | 1.79 | 3.48 | 4.69 |
| Real Value of: | | | | | |
| Retail Trade | 89.04 | constant 10 ⁹ 1961 dollars | 1.15 | 1.38 | 1.65 |

6.4.2 Projection Procedure and Results

Projections of total BTU's were obtained by substituting forecasted values of retail trade and the average price per BTU in equation (27). The projected consumption of each fuel was obtained by using the logit model (equations (28)-(31)) to forecast shares for three of the fuels, then multiplying the forecasted share times the forecasted total volume of BTU's consumed in the sector.

These simulation results are presented in Table 19. Figure 11 gives the comparison of the three forecasts of total BTU's consumed in the commercial sector. Because of the substantial change in the real prices, the microdemand model exhibits less growth than the energy/GNP ratio model and far less growth than the exponential time trend.¹³

Turning to the specific fuels, the exponential time trend forecasts growth substantially above either of the other two models for electricity, oil products and natural gas. The microdemand model and energy/GNP model predict similar changes in the demand for electricity. This is somewhat surprising since the own price elasticity for electricity is $-.3$ and electricity prices increase substantially. The microdemand model predicts a lower growth in oil product demand but higher growth in natural gas demand than the energy/output model. The microdemand model predicts a sharp drop in coal demand in the sector in 1972 and then slow growth to 1985. Both other models find coal consumption dropping to zero. Since coal is less than 1% of BTU consumption, these differences are of minimal interest (see Figures 12 to 15).

¹³The reader will note that a linear time trend was used in the residential and industrial sectors while an exponential trend is used in this sector. As expected, the results relative to the competing models change substantially which is an indication of the effect of specification in naive models.

Table 19. Endogenous variables: commercial (Ontario).

| Variable | Actual 1971 Values | Units | Projected Values to 1971 (1971 = 1.00) | | | | | | | | |
|-------------|--------------------------|-----------------------|--|------|------|------|------|-------|------|------|-----|
| | | | 1975 | | | 1980 | | | 1985 | | |
| | | | 1a) | 2b) | 3c) | 1a) | 2b) | 3c) | 1a) | 2b) | 3c) |
| Coal | 3.354 | 10 ⁶ BTU's | 0.75 | 1.24 | 0.74 | 0.36 | 0.93 | 0.17 | 0.17 | 1.01 | |
| Fuel Oil | 84.127 | 10 ⁶ BTU's | 1.46 | 1.46 | 1.05 | 2.20 | 1.26 | 3.32 | 2.64 | 1.19 | |
| Natural Gas | 72.923 | 10 ⁶ BTU's | 2.48 | 0.97 | 1.27 | 6.46 | 1.77 | 16.86 | 1.72 | 2.81 | |
| Electricity | 64.842 | 10 ⁶ BTU's | 1.72 | 1.12 | 1.14 | 3.16 | 1.48 | 5.81 | 1.96 | 1.92 | |
| Total BTU's | 225.3 | 10 ⁶ BTU's | 1.67 | 1.20 | 1.14 | 2.88 | 1.48 | 4.95 | 2.08 | 1.92 | |

a) Naive time trend model.

b) Naive input-output model.

c) Microdemand model.

d) Negative value.

7. Summary and Conclusions

In this paper we have compared projections of the demand for energy obtained from three models. Two of these models are trending procedures while the third incorporates basic elements of microdemand theory (primarily relative price effects). For total energy and most energy components the microdemand model predicts a pattern of consumption by 1985 which is quite different from that predicted by the naive models. Price effects are shown to be important in reducing the projected growth of demand below past rates and therefore below most forecasts currently available for Canada.

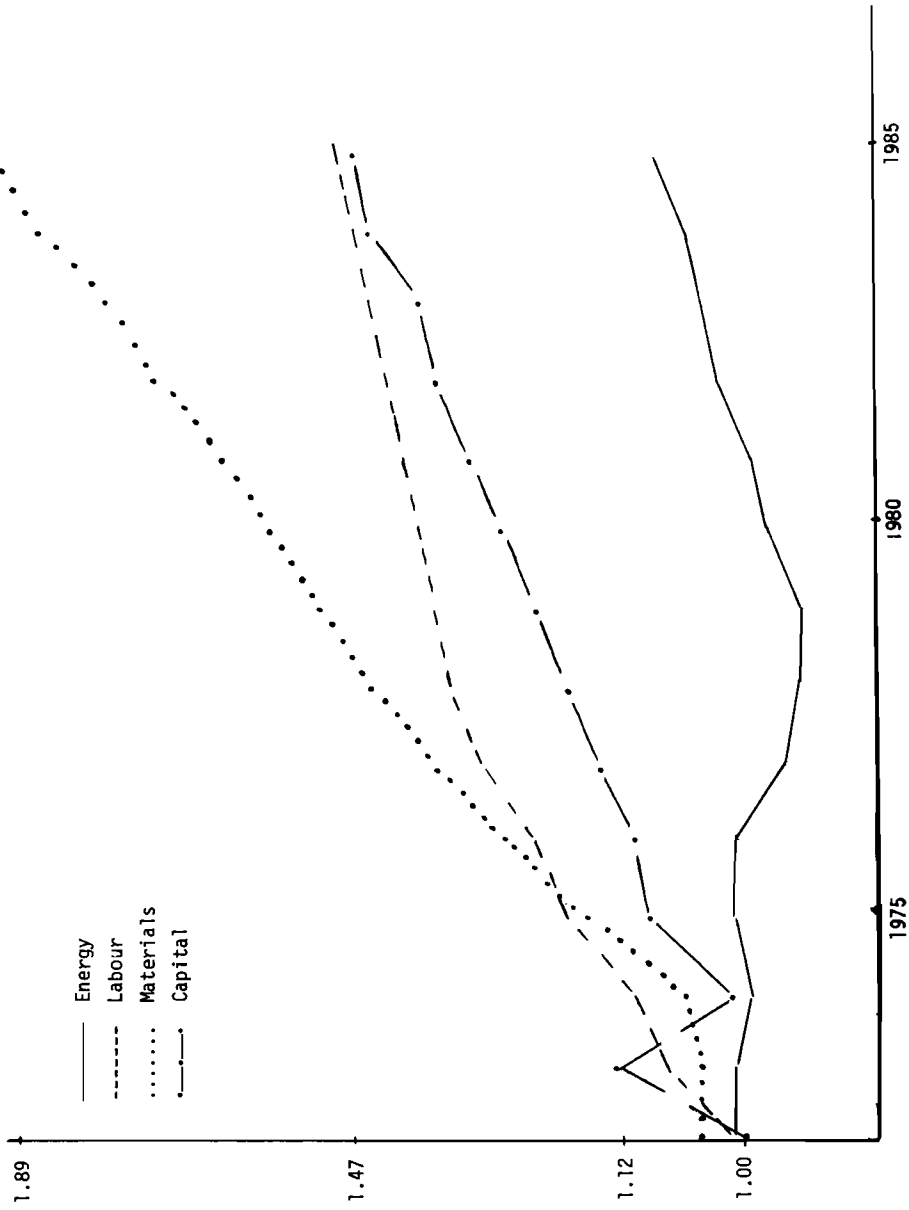

Figure 1. Manufacturing projections (Ontario) 1972-85.
Aggregate Inputs

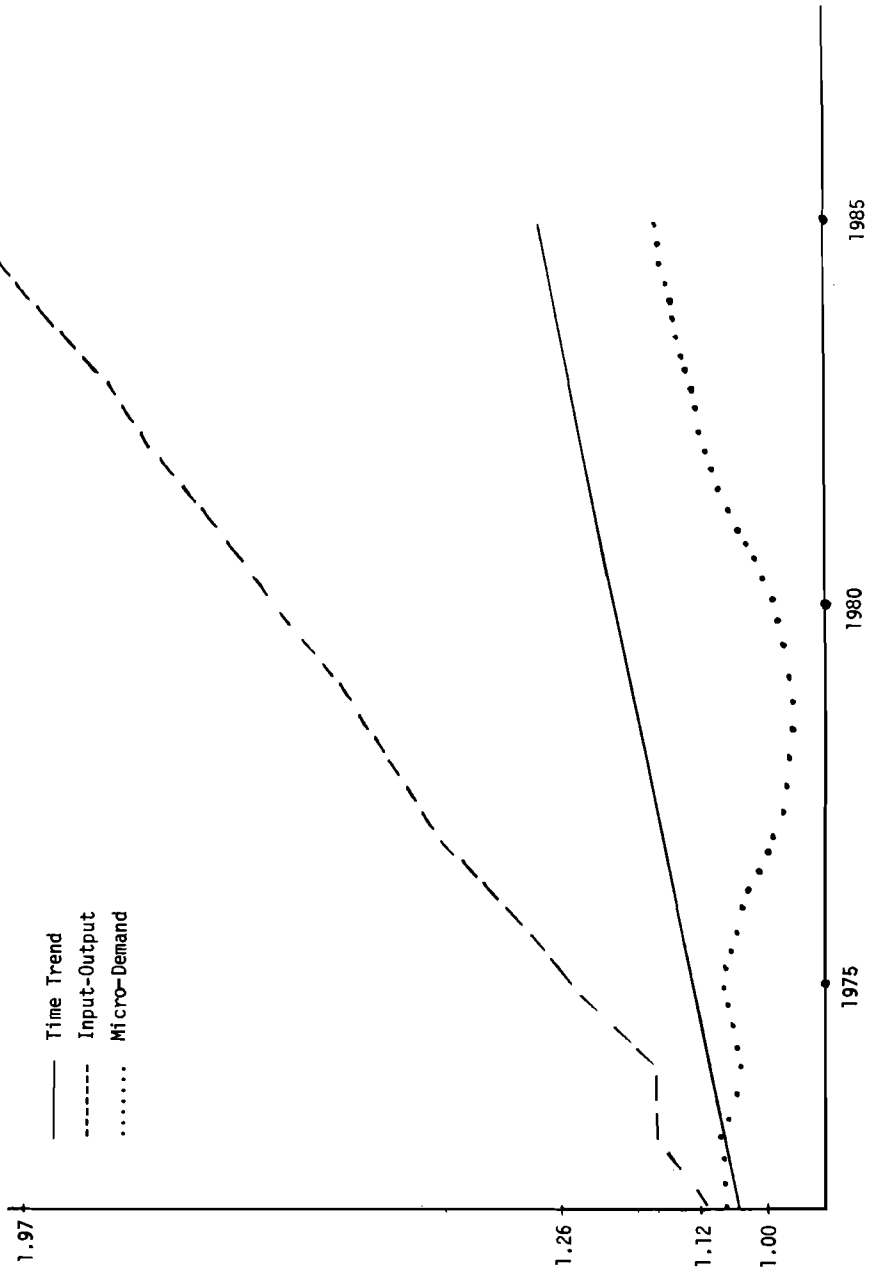

Figure 2. Manufacturing projections (Ontario) 1972-85.
Aggregate Energy

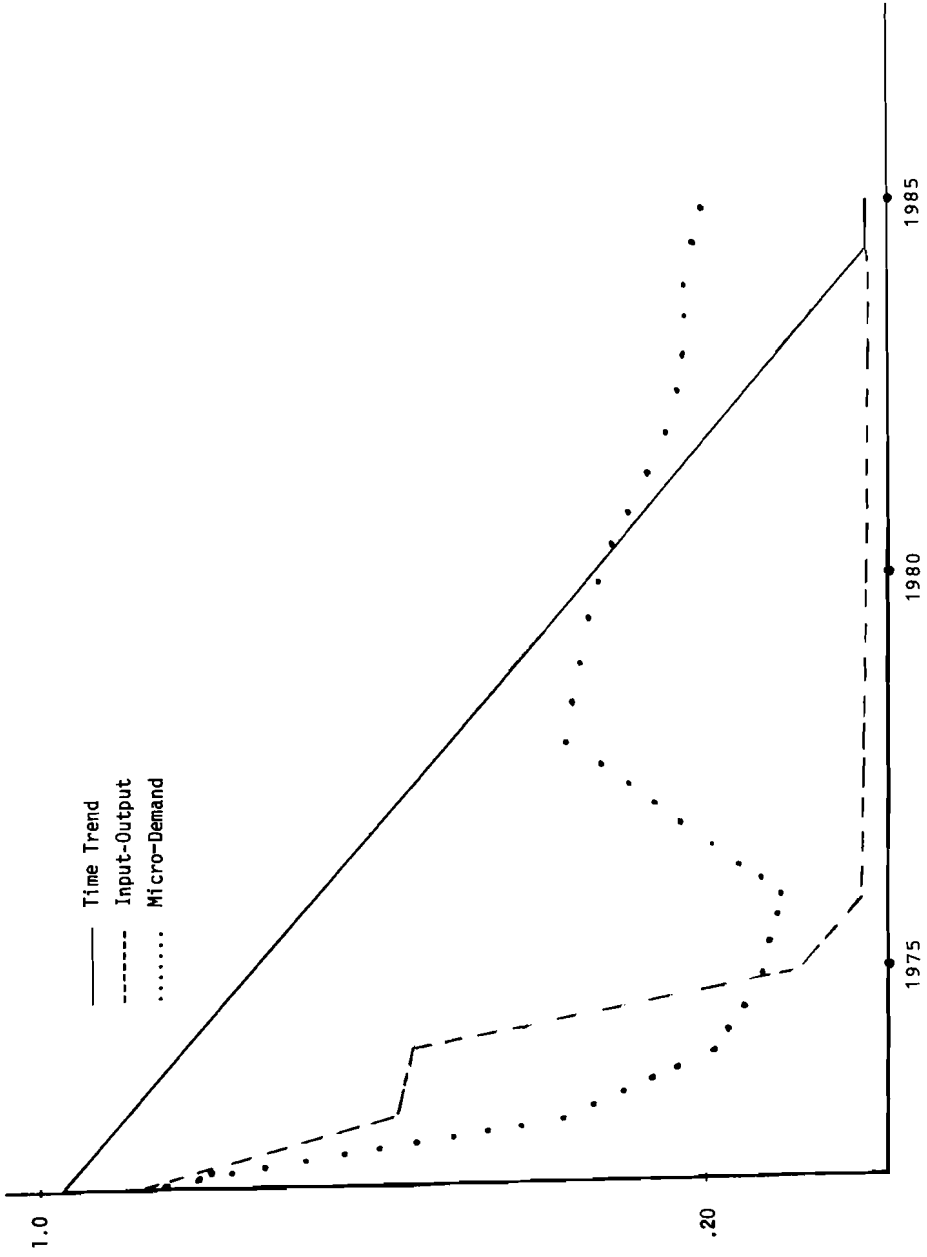

Figure 3. Manufacturing projections (Ontario) 1972-85.

Coal

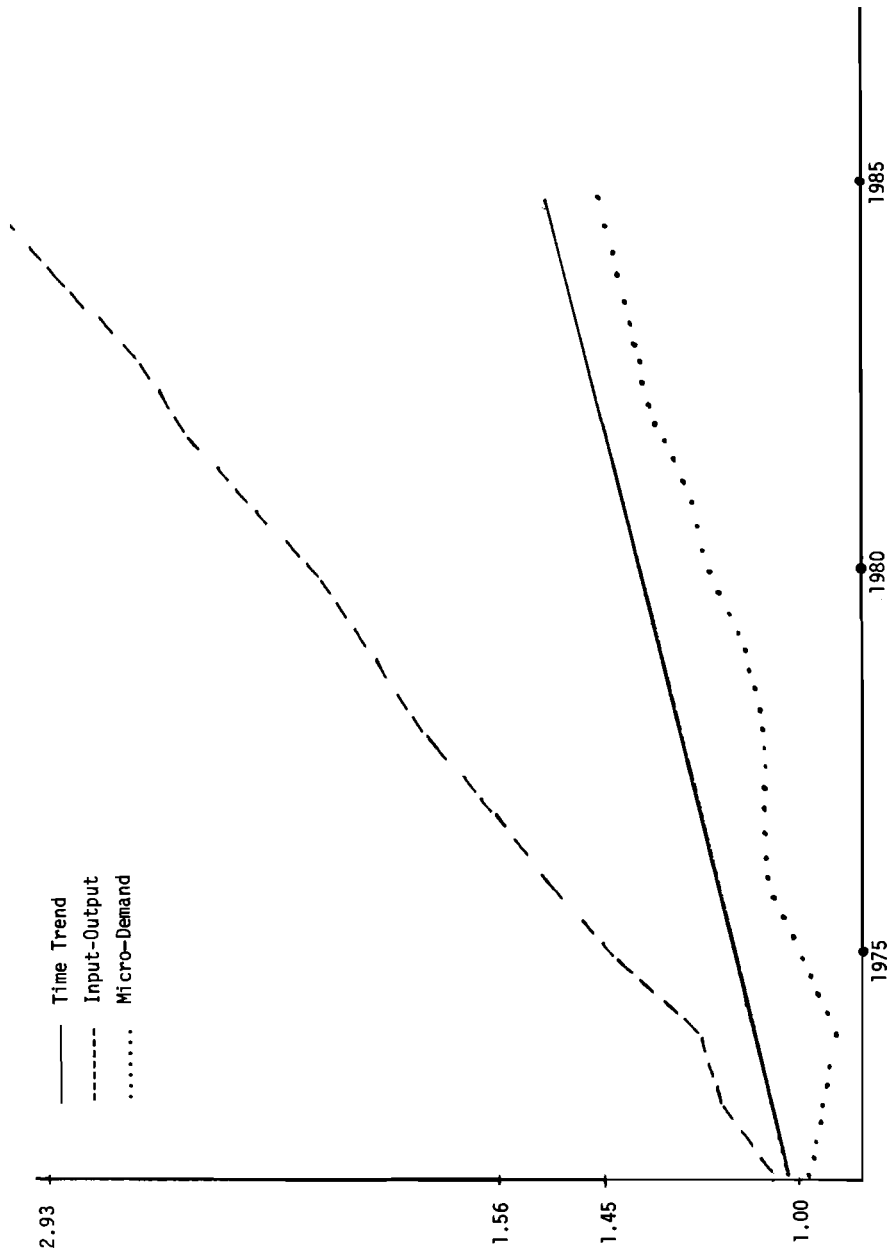

Figure 4. Manufacturing projections (Ontario) 1972-85.
Fuel Oil

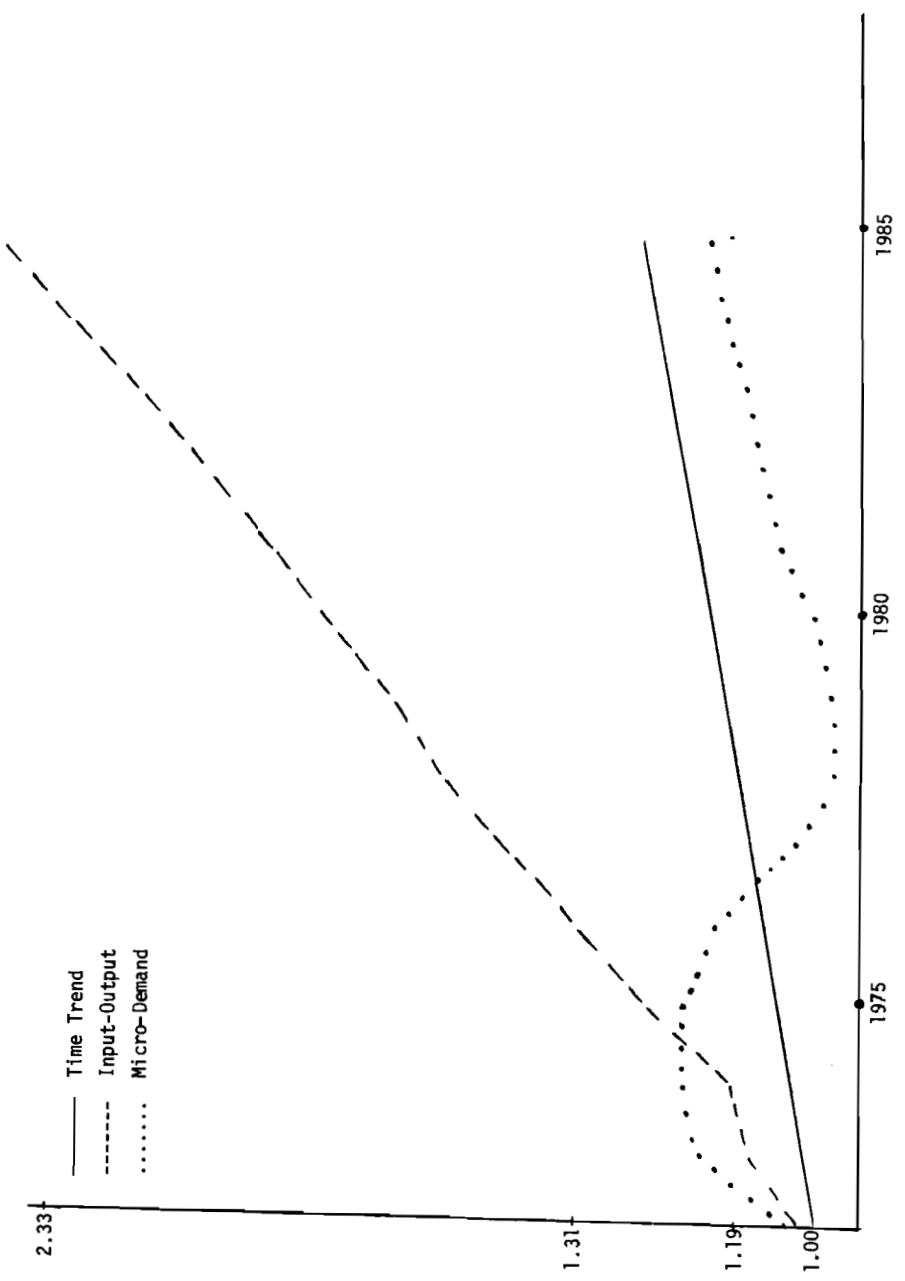

Figure 5. Manufacturing projections (Ontario) 1972-85.

Natural Gas

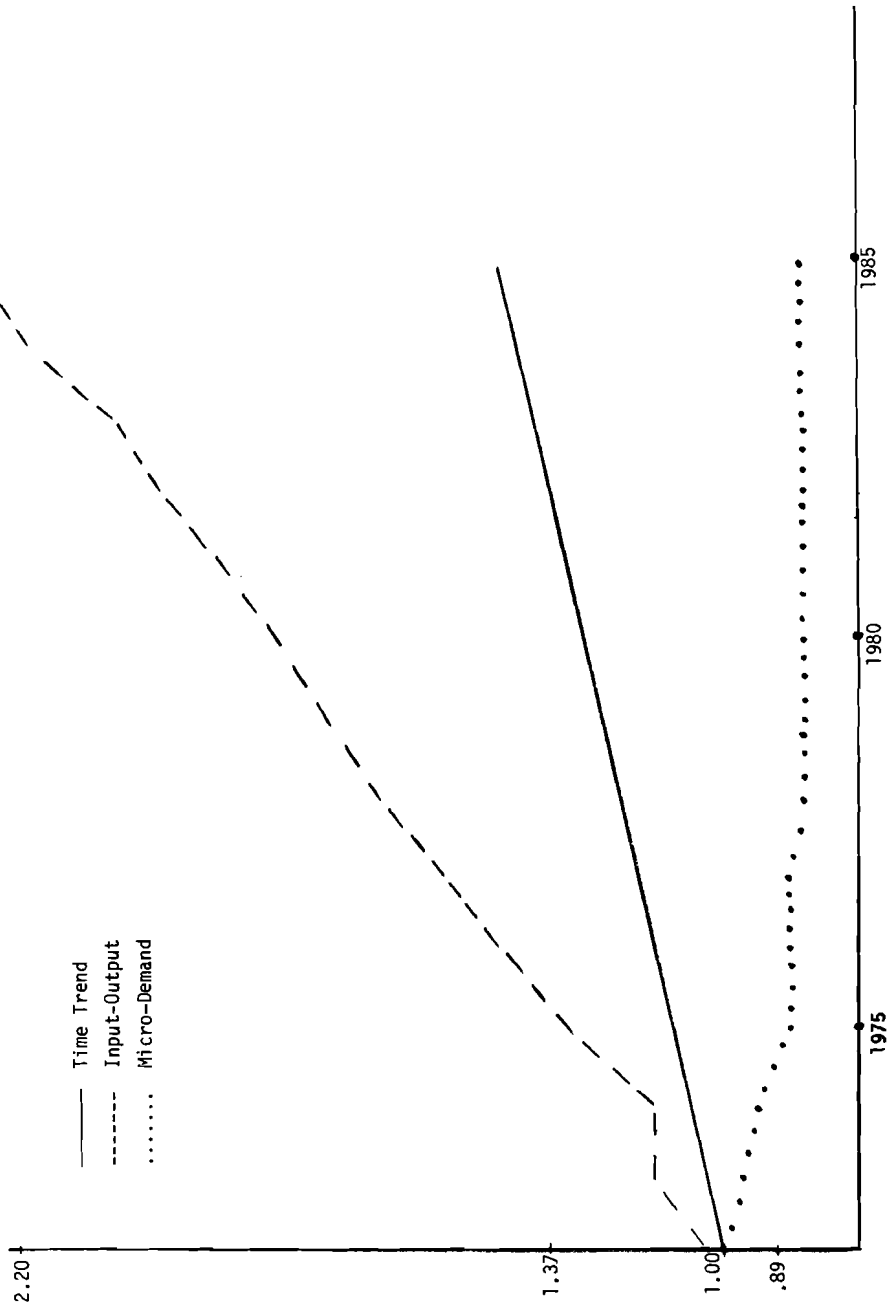

Figure 6. Manufacturing projections (Ontario) 1972-85.
Electricity

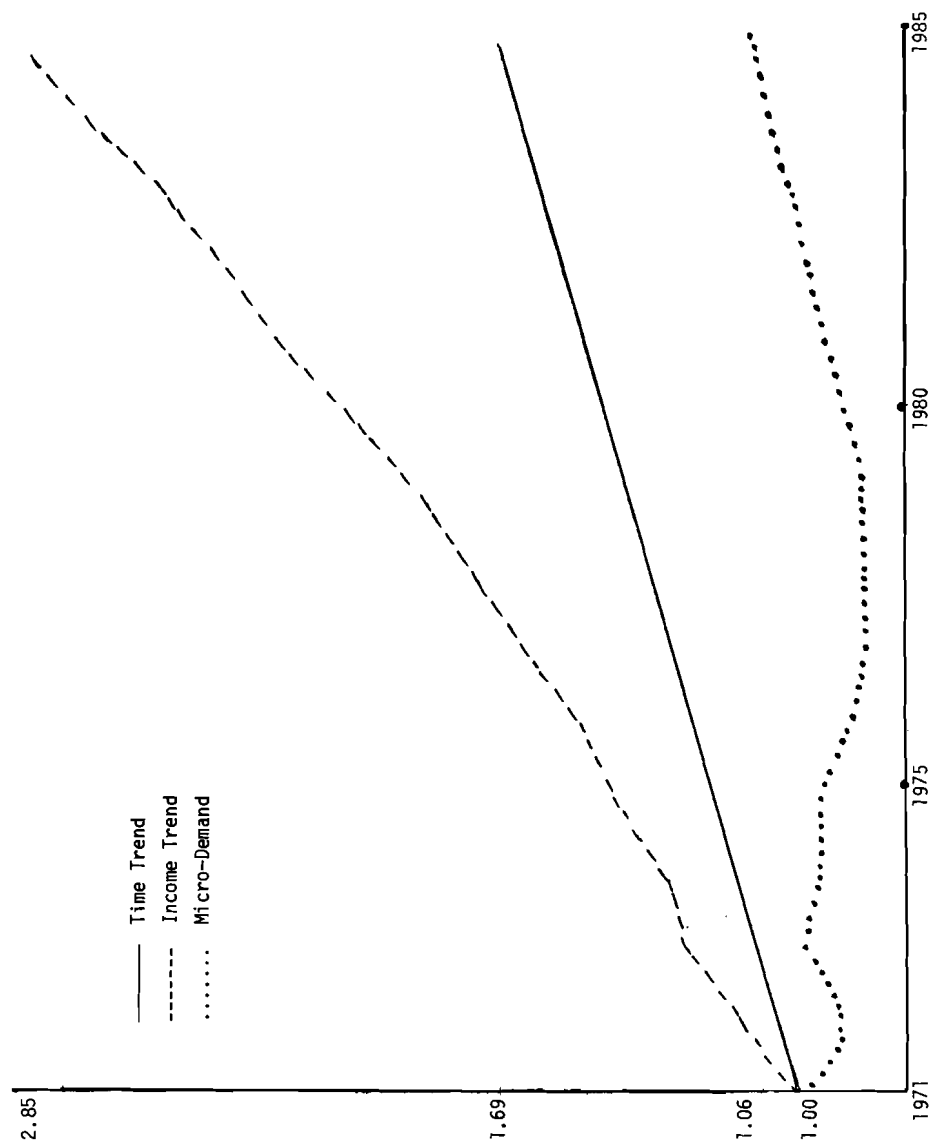

Figure 7. Residential projections (Ontario) 1972-85.
Total Energy

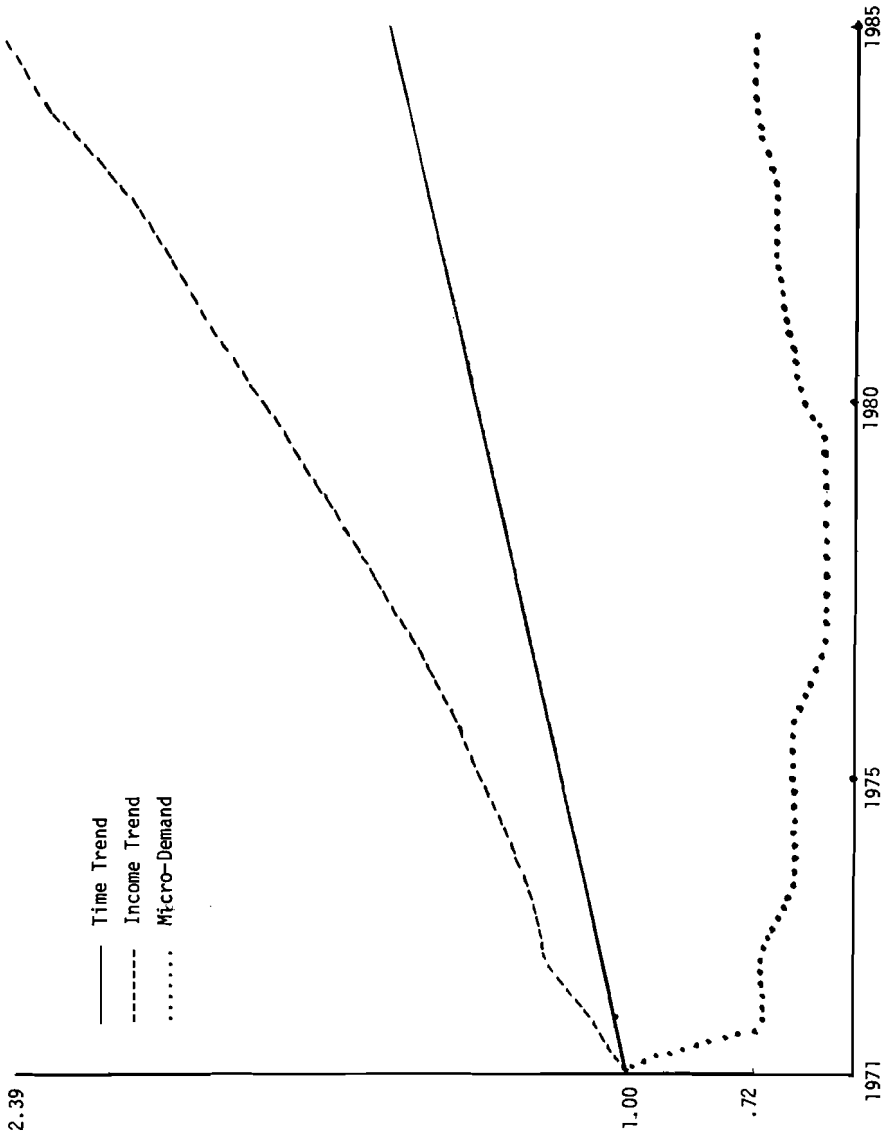

Figure 8. Residential projections (Ontario) 1972-85.
Fuel Oil

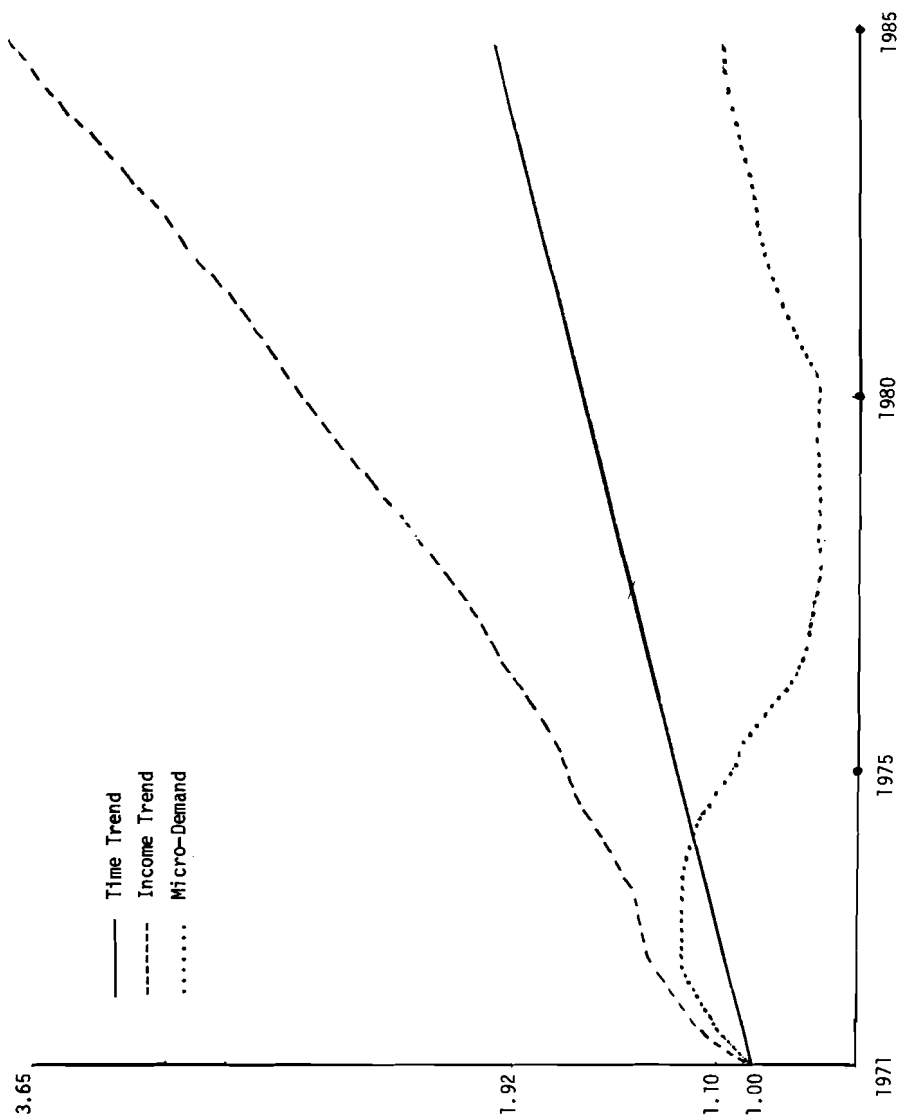

Figure 9. Residential projections (Ontario) 1972-85.

Natural Gas

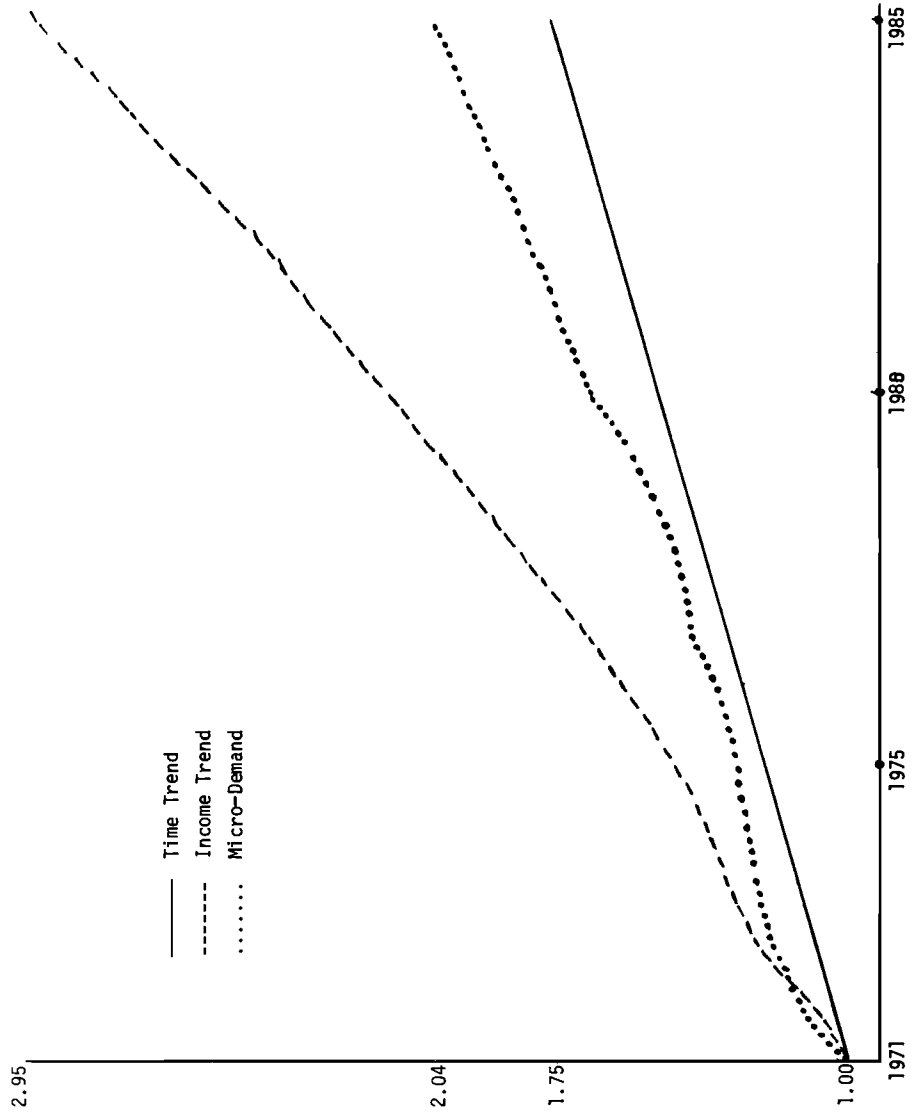

Figure 10. Residential projections (Ontario) 1972-85.
Electricity

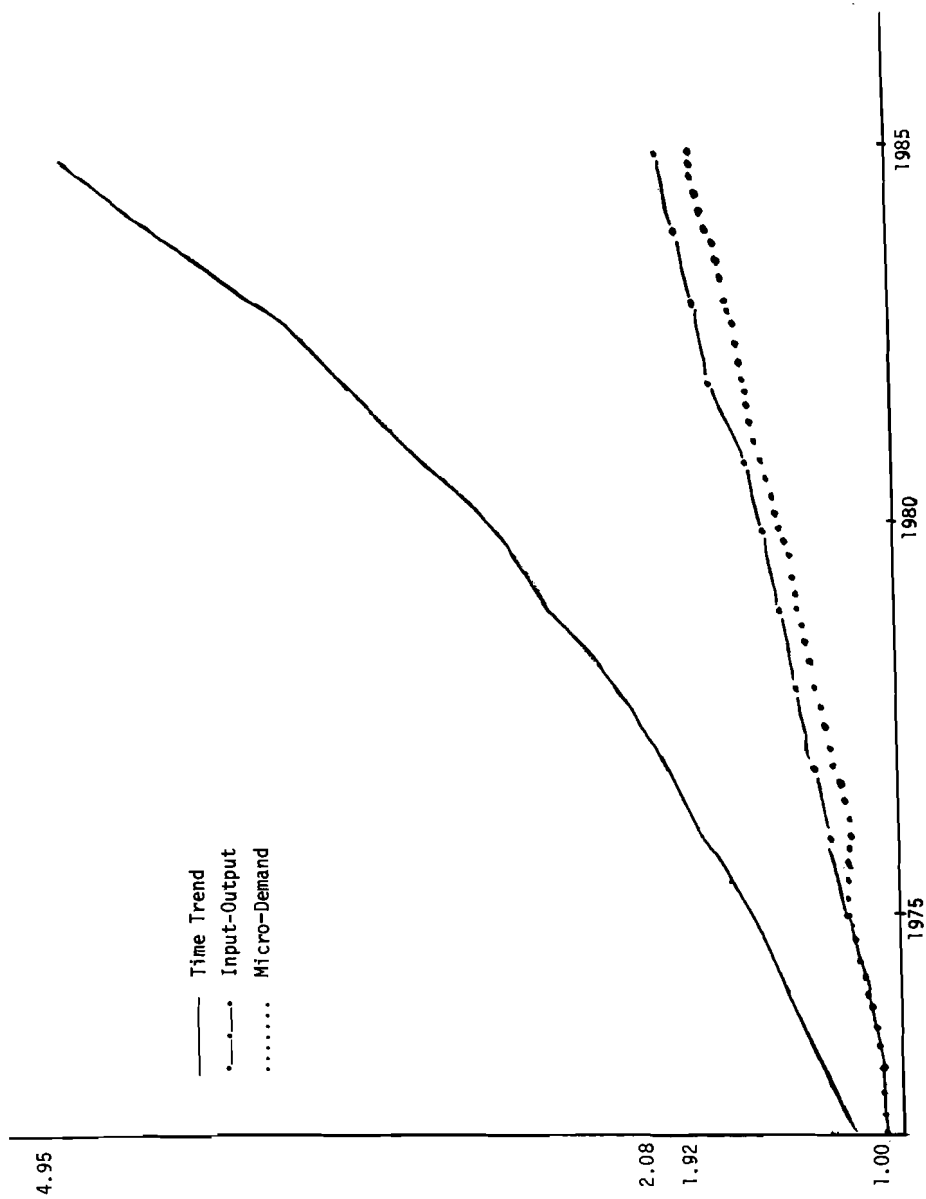

Figure 11. Commercial projections (Ontario) 1972-85.

Total BTU's

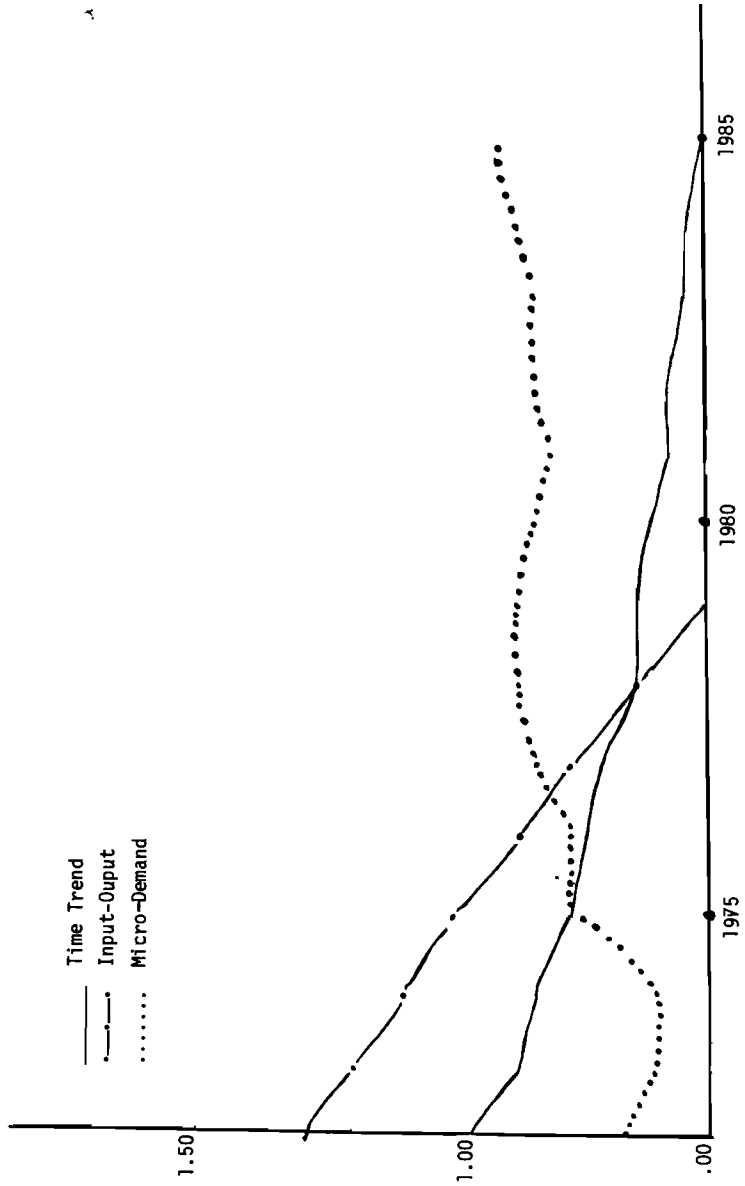

Figure 12. Commercial projections (Ontario) 1972-85.

Coal

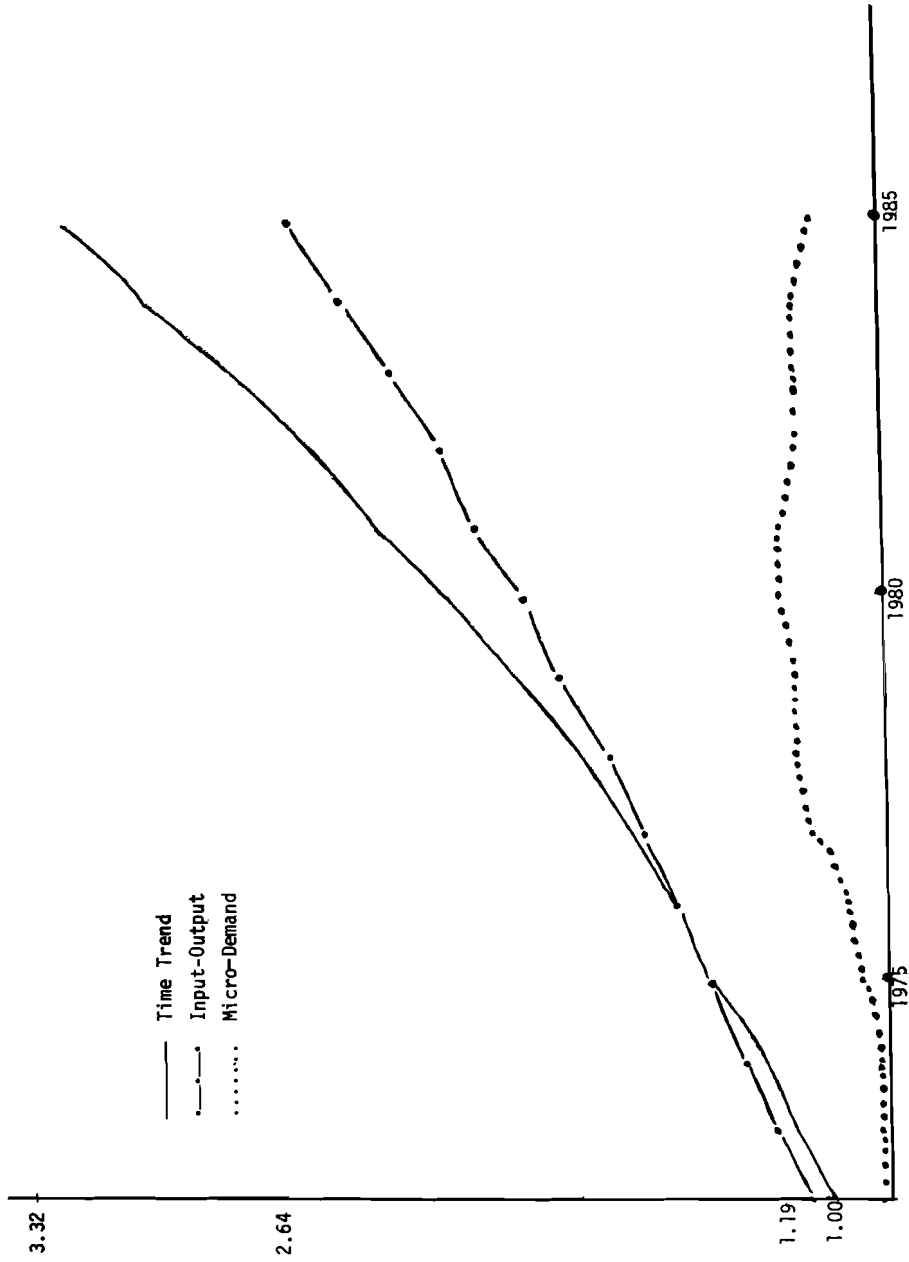

Figure 13. Commercial projections (Ontario) 1972-85.

Oil

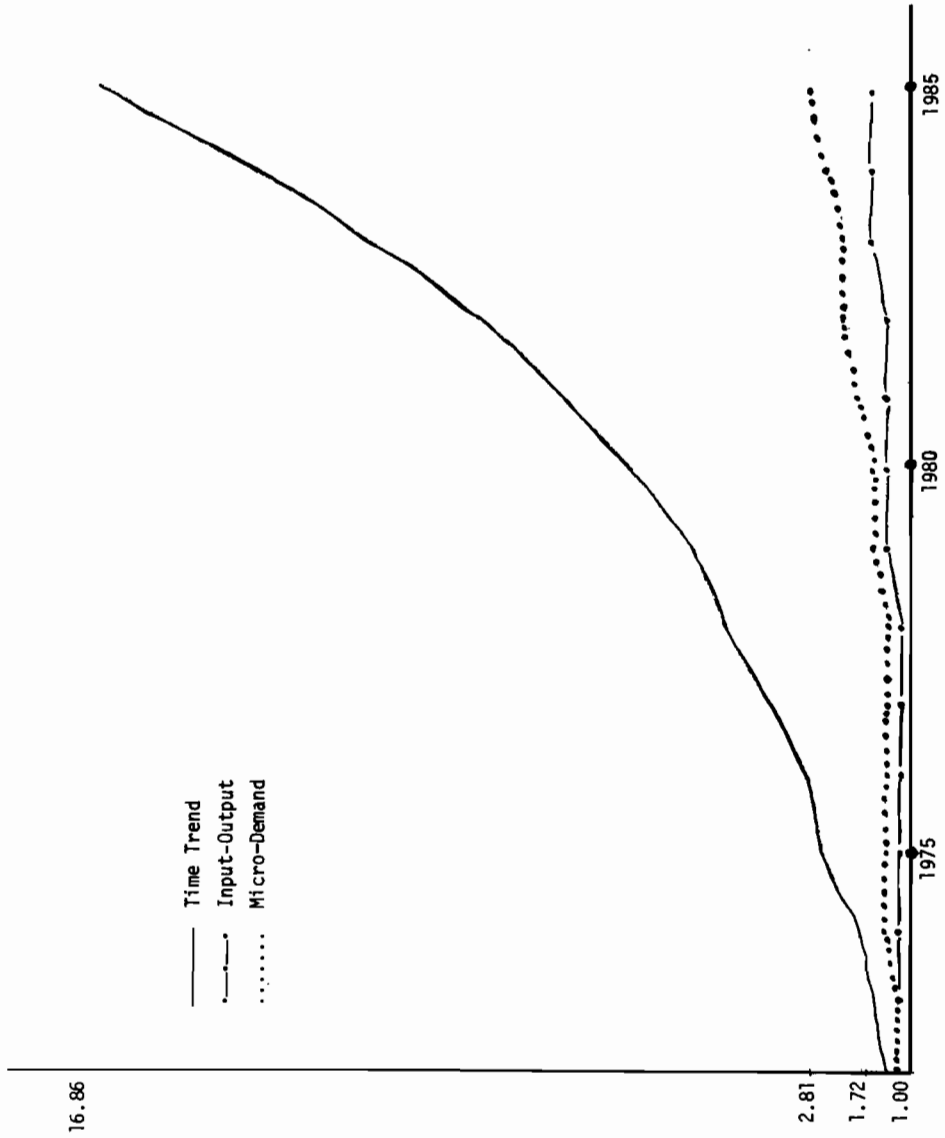

Figure 14. Commercial projections (Ontario) 1972-85.
Natural Gas

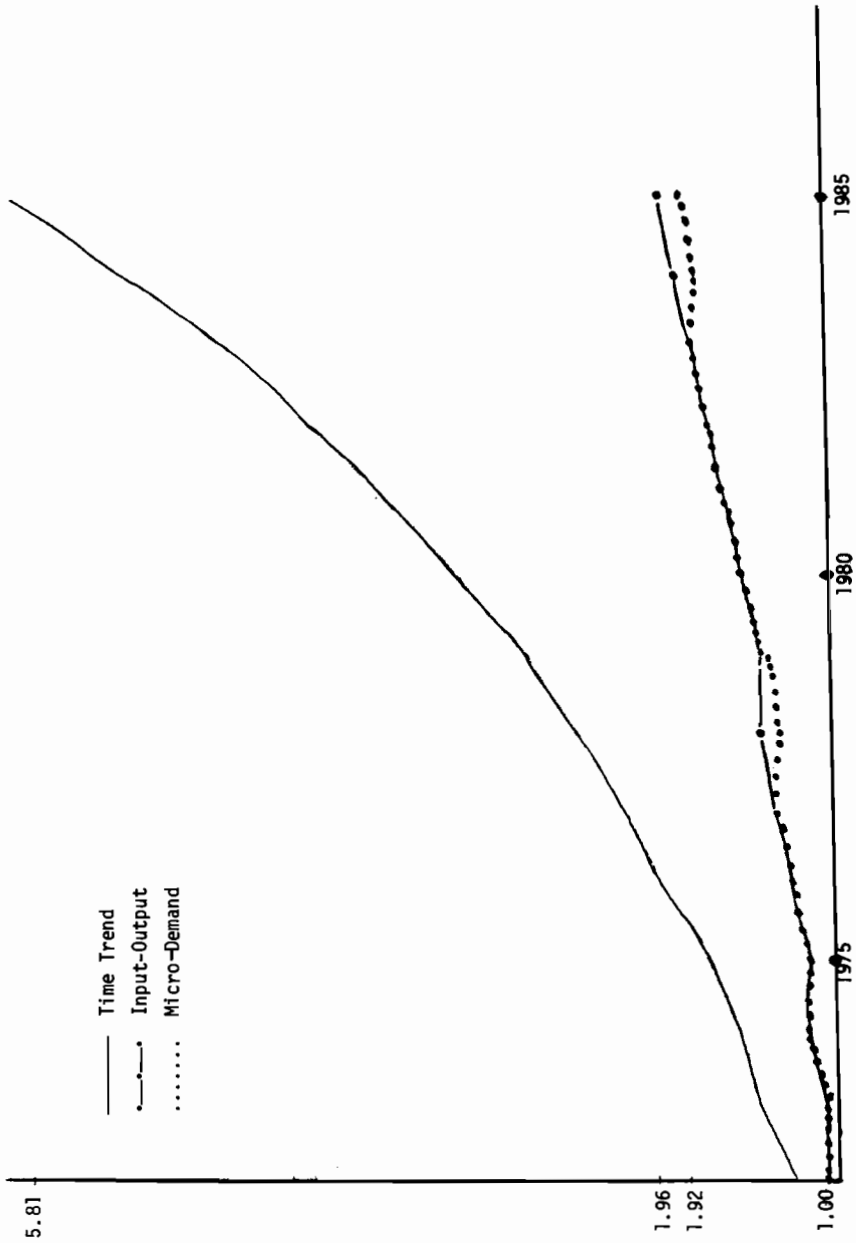

Figure 15. Commercial projections (Ontario) 1972-85.

Electricity

References

- [1] Anderson, K.P. "Residential Energy Use: An Econometric Analysis." Prepared for the National Science Foundation, R1297-NSF, Rand, October 1973.
- [2] Berndt, E.R., and Wood, D.W. "Technology, Prices and the Derived Demand for Energy." Discussion Paper 74-09, University of British Columbia, May 1974.
- [3] Data Resources Incorporated "Energy Model." Unpublished paper, Lexington, Mass., 1974.
- [4] Denny, M.G.S., and Pinto, C. "The Demand for Energy in Canadian Manufacturing: 1949-70." Mimeographed, University of Toronto, 1975.
- [5] Diewert, W.E. "An Application of the Shephard Duality Theorem: A Generalized Leontief Production Function." Journal of Political Economy, May/June 1971.
- [6] Erickson, E.W., Spann, R.M. and Ciliano, R. "Fossil Fuel Energy Demand Analysis." Mimeographed report to the Office of Science and Technology, Decision Sciences Corporation, March 20, 1973.
- [7] Fuss, M.A. "The Demand for Energy in Canadian Manufacturing: An Example of the Estimation of Production Functions with many Inputs." Mimeographed, University of Toronto, April 1975.
- [8] Fuss, M.A., Waverman, L., Hyndman, R., and Dewees, D. "The Demand for Energy in Canada." 3 Volumes. Unpublished report to the Department of Energy, Mines and Resources, February 1975.
- [9] Halvorsen, R. "Demand for Electric Power in the United States." Discussion Paper 73-13. Institute for Economic Research, University of Washington, Seattle.
- [10] Houthakker, H.S., Verleger, P.K., and Sheehan, D.S. "Dynamic Demand Analysis for Gasoline and Residential Electricity." Mimeographed, Data Resources Inc., Lexington, Mass., January 1974.
- [11] Hudson, E.A., and Jorgenson, D.W. "U.S. Energy Policy and Economic Growth 1973-2000." The Bell Journal of Economics and Management Science (Autumn 1974).

- [12] Khazzoom, J.D. "An Econometric Model of the Demand for Energy in Canada." Canadian Journal of Statistics, 1973.
- [13] Mount, I.D., Chapman, L.D., and Tyrell, T.J. "Electricity Demand in the United States: An Econometric Analysis." Paper presented at a conference, "Energy: Demand, Conservation and Institutional Problems", M.I.T., February 1973.
- [14] Statistics Canada. Detailed Energy Supply and Demand in Canada (SC 57-505) C143.
- [15] Statistics Canada. General Review of Manufacturing Industries in Canada (SC 31-202).
- [16] Watkins, G.C. "Canadian Residential and Commercial Demand for Natural Gas." University of Calgary Discussion Paper Series No. 30, May 1974.
- [17] Wilson, J.W. "Residential Demand for Electricity." The Quarterly Review of Economics and Business, 11, 1 (Spring 1971).

Energy Demand Projection for Canada:
An Integrated Approach¹

F. W. Gorbet²

Summary

The analytical framework described in this paper represents a preliminary report on a continuing attempt to model Canadian energy requirements in a rigorous and consistent manner. It explicitly recognizes the dependence of energy consumption on the consumption of other goods and services and the desirability of examining the use of particular energy commodities in the context of a demand for total energy linked to demographic and macro-economic assumptions. The roles played by relative prices and technology are highlighted in a manner that facilitates sensitivity analysis.

The main body of the paper explains the conceptual basis of the analytical framework and describes the current state of implementation. The results of six simulations, three oriented to changes in "macro" assumptions and three oriented to "micro" changes, are presented and briefly discussed.

¹This paper was originally presented at the 104th AIME Annual Meeting held February 16-20, 1975 in New York.

²The usual caveats apply to the research results presented here. In particular, the projections of Canadian energy requirements presented in Section 3 are preliminary model results and in no sense represent Departmental projections of probable outcomes. That said, and explicitly accepting responsibility for any errors of commission or omission, I want to thank the senior officials of the Department for their encouragement and support of this project and, in particular I.A. Stewart and A.R. Scott, who provided valuable advice and criticism.

1. Introduction

An integrated approach to energy policy decisions demands, at a minimum, an analytical framework in which the probable effects of alternative policies on both energy supplies and energy demands can be evaluated. A generally accepted principle of national energy policies is the provision of an adequate amount of competing energy supplies at prices that are reasonable for both the consumer and the producer. The translation of such a principle into specific policy actions, however, requires an appreciation of likely paths of energy demands through time and the sensitivity of these paths to prices, technology and other important influences as well as an understanding of the supply side of the market. Such considerations are important enough when, as has traditionally been the case, energy policies are directed primarily at the supply side of the energy market. In the current environment, when policies are aimed more specifically at energy prices, and consideration is being given to active demand-management policies of various forms, the importance of understanding the demand side of the energy market looms much larger than previously.

This paper reports the preliminary results of a continuing research project to model the demand side of the energy market in a way that facilitates the projection of Canadian energy requirements over a horizon long enough to allow a rational discussion of alternative energy policies, given the lengthy lags that characterize the supply side of the market. Because the horizon is so long the emphasis in this work has been on the development of a consistent framework that will facilitate the quick and easy assessment of the sensitivity of the projections presented to changes in important influences--chiefly relative prices, the pace and direction of technological advance, and the nature and extent of interfuel competition.

Section 2 below treats the conceptual nature of the framework, and describes the current state of implementation. In Section 3 some preliminary projections are presented, and an attempt is made

to portray the relative significance of some of the major assumptions. Finally, in the concluding section of the paper some of the limitations of the present structure are highlighted in the context of our plans for future extension and refinement of the model.

2. The Analytical Framework

2.1 Historical Perspective

The demand for secondary energy³ in Canada, that is BTU's delivered to intermediate and final consumers, has increased from 2,637 trillion BTU's in 1958 to 5,197 trillion BTU's in 1971. This represents an average annual growth rate of 5.4%, higher than the 5.0% average annual increase in real gross national expenditure over the same period. As Table 1 below indicates, however, this growth in the demand for energy has been far from evenly distributed, over either end-use sectors or energy sources.

In terms of the sectoral distribution of energy requirements, the commercial sector has shown the strongest growth, with average rates in excess of 11%. Over the fourteen year period considered, the share of total BTU's demanded by this sector doubled from about 7% to 14%. The residential sector was characterized by the slowest rate of increase of any of the four major end-use sectors, although within the transportation sector different modes have experienced widely differing growth trends. The demand for energy used in air transportation, for example, increased at a

³Typically energy statistics are presented in terms of secondary energy or primary energy. Secondary energy comprises total BTU's sold to intermediate and final consumers. It understates actual energy use by ignoring conversion losses. Primary energy, on the other hand, includes conversion losses but overstates actual energy use because it embodies an accounting convention that values hydro and nuclear electrical generation as if the electricity were produced from fossil fuels. The rationale for this procedure is that one obtains a series of energy consumption statistics that is independent of the particular mix of hydro and nuclear electrical generation. It is therefore the most useful accounting concept for making comparisons among different countries, or within the same country over long periods of time.

Table 1. Secondary energy demands in Canada:
historical perspective.

| Growth Rates: 1958-1971 | | | |
|-------------------------|-----------------------------|-------|-----------------------|
| End-Use Sector | Trillions of BTU's Demanded | | Average Annual Growth |
| | 1958 | 1971 | 1958-1971 |
| Residential | 639 | 1,056 | 3.94 |
| Commercial | 186 | 734 | 11.14 |
| Industrial | 766 | 1,421 | 4.87 |
| Transportation | 735 | 1,251 | 4.18 |
| Road | 496 | 954 | 5.16 |
| Rail | 127 | 90 | -2.62 |
| Air | 40 | 100 | 7.30 |
| Marine | 72 | 107 | 3.09 |
| Energy supply & losses | 294 | 713 | 7.05 |
| Non-energy use | 17 | 22 | 2.00 |
| TOTAL | 2,637 | 5,197 | 5.36 |

| Market Shares: 1958-1971 ¹⁾ | | | | | | | | |
|--|----------|-------|------|-------------|----------|-------|------|-------------|
| | 1958 (%) | | | | 1971 (%) | | | |
| | Coal | Oil | Gas | Electricity | Coal | Oil | Gas | Electricity |
| Residential | 19.6 | 58.8 | 12.4 | 9.2 | 1.0 | 60.1 | 23.8 | 15.0 |
| Commercial | 21.7 | 38.5 | 20.4 | 19.4 | 1.1 | 46.1 | 30.0 | 22.2 |
| Industrial | 42.2 | 24.3 | 8.2 | 25.3 | 15.5 | 28.7 | 31.9 | 23.9 |
| Transportation | 8.0 | 92.0 | - | - | .5 | 99.5 | - | - |
| Road | - | 100.0 | - | - | - | 100.0 | - | - |
| Rail | 38.6 | 61.4 | - | - | 2.0 | 98.0 | - | - |
| Air | - | 100.0 | - | - | - | 100.0 | - | - |
| Marine | 13.7 | 86.3 | - | - | 3.6 | 96.4 | - | - |
| TOTAL | 20.8 | 55.5 | 11.6 | 12.1 | 4.9 | 56.3 | 24.8 | 14.0 |

Source: Detailed Energy Supply and Demand in Canada
(Stat. Can. 57-207).

¹⁾ Coal includes coke and coke oven gas; oil includes liquefied petroleum gas.

rate of about 7.3% per year, on average, while energy used for rail transportation declined throughout the period, by a little more than 2.5% per year.

With respect to the historical pattern of demands for four major energy sources, one can see some notable shifts in market shares supplied by alternative fuels. A slight increase in the share of the market held by petroleum products and electricity is observable through the period, but the major shift in fuel use has been from coal to natural gas. While the share of coal in total energy consumption declined from 20.8% in 1958 to 4.9% in 1971 the share of natural gas increased from 11.6% to 24.8%. This substitution was most marked in the industrial sector, where the market share held by natural gas more than tripled over the period.

This rather brief look at the historical perspective raises two methodological issues. In the first place, what are the diverse influences that have led to relatively smooth and stable relations between total energy demand and aggregate economic activity, while at the same time causing substantial shifts in the distribution of energy consumption among end-use sectors and competing energy sources? Second, and more important, if one can at least notionally identify the several causal influences at work in the historical period and their interrelationships, what is the "best" way to account for future effects of the same or similar influences in a projection horizon that extends twenty-five years into the future?

2.2 Some Conceptual Considerations

The analysis begins from the fundamental proposition that the demand for energy is a derived demand: users do not demand energy because of any intrinsic utility it possesses but rather because it is essential in the provision of goods and services deemed necessary or desirable. This characteristic of energy demand is readily recognized in end-use sectors such as the industrial sector, where energy is used as an input into the productive process. In this sector the demand for energy, as is the case with the demand for any other input, is determined by the demand

for the industry's output together with a technologically-based production function and relative factor prices. The inherently derivative nature of the demand for energy, however, is no less characteristic of any end-use. A desire on the part of an individual consumer to surround himself with a "comfortable" environment will result in a demand for energy that depends on the precision with which he specifies "comfort" (the level of demand for the final service), the various alternative methods by which that environment can be provided (a technologically based set of consumption possibilities) and the relative costs of the alternative methods (relative factor prices).

One of the implications of explicitly recognizing this principle is that, over a wide range of uses, different energy sources may be highly substitutable (depending on the current state of technology). In such cases it is possible to consider the demand for an amorphous commodity called "BTU's" required to provide a menu of goods and services distinct from the demands for the specific energy sources from which those BTU's will be derived. Indeed, it is the case that different sources supplying energy to the same use are characterized by sometimes quite different efficiencies of utilization, so that total energy demands, as measured in the traditional sense, may, with given technologies and final demands, be very different according to how energy markets are divided among energy sources. For example, the use of electricity in residential space heating is roughly 1.5 times more efficient than the use of light fuel oil.⁴ Thus if 100% of residential requirements are for space heating and the sourcing of that 100% shifts from 25% electricity and 75% oil to 75% electricity and 25% oil one would note a decline in total BTU's

⁴This is a pure combustion efficiency in terms of BTU's out of the converter per BTU's in. It has nothing to do with insulation levels or other characteristics affecting heat retention. The generally higher insulation levels for electrically heated homes, together with the generally "below optimum" operating characteristics of oil-burning furnaces, may make any actual comparison even more favourable to electricity. It should be noted, however, that the discussion and example presented at this point are in terms of secondary energy only. Conversion losses, not included here, are discussed more fully below.

demanded by the residential sector of about 17%, even though the level of service has not changed.⁵ Alternative ways of sourcing energy uses in particular markets may cause substantial variation in projections of aggregate energy use. Most observers agree, and empirical studies have affirmed, that the elasticity of demand for some concept of "total" energy with respect to price is much lower than the price elasticity of particular energy sources. The nature and extent of interfuel substitutions in specific markets thus emerges as a major influence that should be explicitly accounted for in energy demand projections.

In general, previous attempts to forecast energy requirements over any lengthy horizon proceeded by attempting to isolate past trends in energy consumption and correlate these trends to measures of aggregate activity and relative prices. With few exceptions these exercises were concerned with specific fuels or end-use categories. There was no attempt to deal in a rigorous or consistent fashion with either the total range of energy demands, energy supplies, relative prices and general levels of macro-economic activity. As well, most of these studies ignored explicit changes in technology and their probable impacts on energy requirements.⁶

⁵It is interesting to note from Table 1 that the residential sector, which had the lowest average annual growth rate of the four major end-use sectors from 1958-1971 was also marked by the greatest increase in the market share provided by electricity. One would not want to push this too far, however, since the state of the data precludes a proper analysis. The residential sector includes farm use and the commercial sector includes all consumers purchasing energy at commercial rates, for example large apartment buildings. Thus an alternative explanation of the same observation may be simply that farm use of energy is growing much more slowly than the average, or that large multiple dwellings are growing more than proportionately. Presumably all three of these factors have been in play at various times in the historical period considered.

⁶There is one notable exception. The work done by Jorgenson and Hudson goes a long way toward integrating a well-specified-demand-for-energy model with a macro-economic growth model. However, the present state of the system lacks appropriate feedback mechanisms and, although technology is allowed to adjust to relative price shifts in an explicit way, the adjustment mechanisms do not appear adequate in many cases. See E.A. Hudson and D.W. Jorgenson, "U.S. Energy Policy and Economic Growth, 1975-2000," The Bell Journal of Economics and Management Science, 5, 2 (Autumn 1974), 461-514.

The interactions between alternative states of technology and resulting energy demands are too important to be ignored or impounded in a simple *ceteris paribus* clause. As noted above, the efficiencies with which alternative energy sources perform essentially the same use may be quite different. The example given was for electricity and light fuel oil in residential space heating, but an even more striking example can be found in the area of rail transportation, where diesel locomotives are roughly three times more efficient than steam locomotives. The state of technology thus impinges directly on the determination of BTU's required to perform a specified function, given the distribution of the market among competing energy sources. It also, of course, contributes directly to a determination of that distribution, by delimiting the extent of interfuel competition that is possible in any market at any time: it is clear that electricity has virtually no role to play in road transportation with present technology, but it is less clear that this will continue to be true in the longer run. Just as changes in technology impinge on energy demand projections by increasing the range of uses for a particular source, so they may also serve to extend the number of sources available for a particular use, both through the development of new sources and the design of appropriate delivery systems for existing sources. Finally, to return to the original input/output concept with which we began, the energy-intensity of the final demand bill from which gross energy requirements are originally derived is very much a function of the state of the art.

Economists have not ignored the effects of relative prices on energy demands. Indeed, empirical investigations have indicated rather strong own-price elasticities for several fuels in particular markets, which is the area in which most testing has occurred. This is not surprising given the historical performance of energy prices relative to other prices. In the residential sector, for example, the price of fuels and utilities in the Consumer Price Index (CPI) as a ratio of the aggregate CPI fell from 1.035 in 1958 to .886 in 1971. In manufacturing, the

implicit price index for fuels and electricity purchased fell from 1961 to 1971 by 30% relative to average wage rates in manufacturing and by 9% relative to the GNE deflator. Energy had become an increasingly better buy and it is not surprising or inappropriate that statistically significant inverse relationships should be found between energy use and energy price.

The hard question that has to be answered is with what degree of confidence can the elasticity estimates derived from a period of gradually falling relative prices be applied to a projection period that, by all accounts, may be characterized by rapid increases in relative energy prices? The answer of course is not obvious and very much a matter of judgment. My own predilection is to be fairly skeptical of simple projections based on estimated elasticities for the following reasons:

- 1) The specifications typically employed are too partial. They are partial in one sense in that they usually treat particular fuels or particular markets, with a notable lack of consistency checks to ensure that aggregate energy demands summed from individual equations make sense in terms of some broadly defined input/output framework and macroeconomic projection. They are partial in the second sense that often important cross-elasticities are assumed zero or unconstrained. It is often the case, as well, that the failure to embed the projectors in a fully specified model can lead to inconsistent estimates of the price and activity variables feeding into the particular equations. A more fully integrated systems approach in which attention is paid to the consistency of total energy demands with demands for particular fuels and relevant cross-elasticities would be a sounder theoretical system from which to extract meaningful price elasticities.
- 2) The specifications too often, as well as being partial, ignore the derivative nature of energy demands in the definition of price variables. If final demands for

energy are truly derived from demands for services then the appropriate price to test in energy demand equations is not the price of energy itself but the user cost of the service it provides. This of course includes the price of energy, but takes into account the replacement cost and depreciation rate of the energy-using capital equipment as well.

Quite apart from the nature of the specifications employed one must satisfy oneself on the relevant neighbourhood within which the elasticity estimate makes sense, and also whether the estimated magnitude is symmetric with respect to increases and decreases in relative prices. Starting from the same initial conditions, will the elasticity be the same for a 5% and a 50% increase in relative prices? Will it be identical for a 10% increase and a 10% decrease in relative prices? What are the lags with which an increase in energy prices will induce a decrease in energy use? Most people agree that the approach to equilibrium is quite protracted since the process of adjustment entails replacing existing capital appliances with more energy efficient appliances. To what extent, however, have the falling relative energy prices experienced for the last decade left us with a set of initial conditions from which the productivity of energy can be increased markedly and quickly?⁷ These questions are important enough to suggest that in long-term projections of energy demands it makes sense to allow users to treat estimates of price elasticities and adjustment periods as parameters in a series of sensitivity analyses rather than as constants.

⁷One hears the view expressed quite often that there is a lot of "waste" or "fat" in our energy system. What is meant in economic terms is that the cost of energy has been so low relative to either capital costs or total operating costs that the marginal cost of improving energy efficiency has been greater than the marginal benefit of so doing. Increases in the relative price of energy shift the results of this calculus, and some evidence indicates that at current prices large and immediate increases in energy efficiency can be "profitably" attained.

These three factors--interfuel substitutions, technology and relative prices--are critical in any attempt to assess future energy demand profiles. Their effects are felt in influencing both the input/output relationships between final demands for goods and services and energy requirements and also the relative sourcing of energy markets. The methodology described below treats energy demand projections in a consistent framework that makes explicit the decision points where alternative assumptions about relative prices, technology, and interfuel substitution can be brought to bear on the results.

2.3 Implementation of the Model

Before discussing the structure of the model a word about the database employed and the level of disaggregation is in order. The energy demand database modelled in this activity is published in Detailed Energy Supply and Demand in Canada.⁸ This publication reports the annual consumption of energy, for sixteen fuel types, by ten end-use sectors. Energy consumption figures, in BTU's as well as natural units, are detailed for the five statistical regions of Canada.

The fact that the data are presented by end-use sector rather than end-use presents conceptual difficulties. The notion developed in this exercise, that energy demands are derived from demands for final goods and services through two sets of input/output relationships⁹ logically requires that energy demands be analyzed at a level of aggregation that corresponds to distinct

⁸See Statistics Canada publications 57-505 (occasional, containing 1958-1969 data) and 57-207 (annual, containing 1970-71 data).

⁹The two distinct sets of input/output frameworks are first the relationships that map total output BTU's into final consumption levels and patterns and, second, those input/output coefficients that relate input BTU's to output BTU's. The second set of relationships, and the conceptual differences between input BTU's and output BTU's, is fundamental to our analysis and is described in more detail below.

end-uses of energy. Thus within the residential sector, for example, it would be preferable to distinguish heating and non-heating uses of energy, since the markets for these two uses are characterized by different technologies. Similarly, one might better consider total space heating and cooling demands as a separate end-use, regardless of the sector making those demands. Unfortunately, the collection of energy consumption information is not available on an end-use, as contrasted with an end-use sector, classification basis. In addition, the published data in the supply/demand balance also pose conceptual problems even within their own classification on the basis of end-use sectors.¹⁰

Given these conceptual deficiencies in the database, it is not apparent that the information available from the supply/demand balances corresponds in its level of disaggregation to the homogeneous groups which economic theory suggests can be analyzed to produce structurally appropriate aggregate demand projections. Nevertheless, for all their conceptual inadequacies in the context of the methodology proposed here, the energy balances have been selected as the preferred database for this exercise. They do represent the longest available time series of total energy demands in Canada on a consistent classification basis, and the adjustment from an end-use sector basis to a true end-use basis will be relatively easy to make at such time as more economically meaningful information on Canadian energy flows becomes available.

¹⁰The statistical sampling is done on the production and distribution side of the energy market, rather than directly on the consumption side. This leads to some rather surprising results. For example, the residential sector includes all farm use (productive and nonproductive) as well as the energy requirements of individual residences; the commercial and industrial classifications are determined (for gas and electricity) on the basis of rates, which means that large apartment buildings may be classified as commercial (or even industrial) whereas small commercial or industrial establishments may fall in the residential category. The commercial category itself is a heterogeneous agglomeration of many end-uses, including space heating for such diverse buildings as shopping centres and airports, all government use of energy, and certain transportation uses (e.g. electrically powered mass transit systems). Comparable classification problems exist within the transportation sector.

The level of disaggregation employed in the model is shown in Table 2 below. Eleven separate fuels (plus oil, which is defined as the sum of kerosene, diesel oil, light fuel oil, heavy fuel oil, motor gasoline and aviation fuels) are considered. The five fuels treated in the supply/demand balances and not included here are coke, coke oven gas, crude petroleum, still gas, and petroleum coke. Coke and coke oven gas are in fact included in the framework, but are not shown separately. Projected requirements for these fuels are converted within the program to derived demands for coal and these demands are added to coal requirements for the industrial sector. Demands for crude oil, still gas, and petroleum coke have typically been confined to the energy supply industries and non-energy uses. They are implicitly included in the projected demands for oil for these end-use sectors but no attempt to break them out has been made.

We consider ten separate end-use sectors, the same number as is shown in the supply/demand balances. However, we exclude the sector in that publication called "losses and adjustments" which, in effect, is a statistical residual, and we include a sector denoted "fossil fuels used to produce electricity," which shows up as an intermediate, rather than final use, in the supply/demand balances.

Table 2. Fuels and markets considered.

| <u>Fuels</u> | <u>End-Use Sectors</u> | <u>Regions</u> |
|------------------------|---|----------------|
| 1) Coal | Residential | Atlantic |
| 2) LPG | Commercial | Quebec |
| 3) Oil | Industrial | Ontario |
| 4) Natural Gas | Road Transport | Prairies |
| 5) Electricity | Rail Transport | B.C. |
| 6) Kerosene | Air Transport | |
| 7) Diesel Oil | Marine Transport | |
| 8) Light Fuel Oil | Energy Supply Industries | |
| 9) Heavy Fuel Oil | Non-Energy Use | |
| 10) Motor Gasoline | Fossil Fuels Used to Produce Electricity | |
| 11) Aviation Gasoline | | |
| 12) Aviation Turbofuel | | |

The first seven end-use sectors shown in Table 2 are modelled according to the flow chart shown in Figure 1. Development of energy demand projections involves the following seven steps, each of which is more fully described below.

Step 1. Convert, for each region, the BTU's of total energy consumed to measures of BTU's actually utilized. The terminology employed in this study for these two BTU concepts is "input BTU's" and "output BTU's," respectively.

Step 2. Use regression analysis to establish relationships between aggregate output BTU's and aggregate activity and price variables over the period 1958-1971.

Step 3. Using projected values of the aggregate activity variables develop regional projections of output BTU's demanded.

Step 4. If it is deemed desirable the aggregate projections can be adjusted to account for factors not explicitly recognized in the regression analysis.

Step 5. Using whatever projections of market shares seem consistent with anticipated developments in technology and relative prices of alternative energy sources, disaggregate the projections of output BTU's in each region to projections of demands for specific energy sources.

Step 6. Convert the projections of output BTU's by energy source to projections of input BTU's by energy source by applying once again the utilization efficiency factors employed in Step 1 above, adjusted if desired to account for probable changes in efficiency.

Step 7. To this point demands are expressed in terms of secondary energy requirements. One must now derive the additional demands for primary energy implicit in the demand for input BTU's of secondary energy.

These steps are repeated for each of the seven major end-use sectors considered in the context of this basic input/output framework. There are some end-use sectors that do not lend themselves to this treatment and for which demands are projected separately. For example, demands of the energy supply industries are assumed to depend on technologically-determined ratios to total production, and fossil fuels used to produce electricity are derived in the transformation of secondary energy to primary energy described in Step 7 above. Similarly, there are demands for some fuels that are projected independently of this input/output framework because the distinction between input BTU's and output BTU's is not applicable in these cases (i.e., coke, coke oven gas, and feedstocks).

Step 1: Conversion to Output BTU's

Although the concept of BTU is used extensively as a numeraire in energy accounting and aggregation, it is not necessarily the case that a BTU of one fuel has the same useful value as a BTU of another fuel in the same use. Typically, reported consumption data are what we refer to as input BTU's. The concept of output BTU's, on the other hand, is an attempt to get behind the information on fuel consumption to a more appropriate measure of energy that is, in fact, productively utilized. The efficiency with which any energy source is converted to useful form varies widely, depending on the conversion apparatus employed and the end-use desired.

It was noted above that the use of electricity for residential space heating is more efficient than the use of furnace oil by a factor of 1.5. If significant substitutions from light fuel oil to electricity have occurred over the historical period, aggregating the reported consumption of BTU's across all fuels will bias the observed growth rate downward for this use.

To reduce the potential biases inherent in projecting unweighted aggregates and, as well, to introduce into the framework an explicit recognition of utilization efficiencies and possible changes in these efficiencies over time, it was deemed appropriate

to adopt this input/output approach to BTU aggregation. It should be remarked that at the moment the assumed utilization efficiencies do not vary over regions or over time, and the resulting output BTU series may thus still be biased, but at least some measures to remove the bias arising from the past history of interfuel substitution have been introduced.

How do input and output BTU's differ? It is obvious that if a sector is predominantly supplied by energy sources that have similar utilization efficiencies (e.g. road transportation) or if a sector has experienced little interfuel substitution (or alternatively, interfuel substitution among fuels with similar efficiencies) then it makes little difference whether or not one weights them, or if weighted, what particular weights are chosen.

Table 3 shows annual average growth rates for Canadian secondary energy consumption, expressed in input and output BTU's, over the period 1958-1971. A growth rate for output BTU's higher than the corresponding growth rate for input BTU's implies a substitution over time of more BTU-efficient fuels. This trend is characteristic of the residential and commercial sectors, and appears as well in three of the four transportation sectors considered, with road transportation being relatively unaffected by the transformation, as one would expect. The industrial sector is characterized by declining utilization efficiency, which reflects the decline in relative shares of energy supplied to this sector by coal and electricity.

Step 2: Estimates

Energy requirements for the residential, commercial and industrial sectors are projected on the basis of estimated relationships existing over the historical period. Pooled time-series cross-section regression equations, projecting aggregate output BTU's, were isolated for each of these three sectors. Residential energy requirements depend on real disposable income per household, the number of households, the composition of the housing stock, a weather variable and the price of energy relative to the CPI. Variables affecting commercial energy demands are the volume

Table 3. Secondary energy demands in Canada:
input BTU's and output BTU's.

| End-Use Sector | Trillions of BTU's | | | | |
|---------------------------|--------------------|-------|--------|-------|--|
| | Input | | Output | | |
| | 1958 | 1971 | 1958 | 1971 | |
| Residential ¹⁾ | 634 | 1,056 | 411 | 753 | |
| Commercial ¹⁾ | 186 | 734 | 146 | 605 | |
| Industrial | 662 | 1,256 | 587 | 1,078 | |
| Transportation | 735 | 1,251 | 155 | 261 | |
| Road | 496 | 954 | 100 | 192 | |
| Rail | 127 | 90 | 37 | 27 | |
| Air | 40 | 100 | 10 | 29 | |
| Marine | 72 | 107 | 8 | 13 | |
| TOTAL | 2,217 | 4,297 | 1,299 | 2,697 | |

Annual Average Growth Rates (%)

| | Input BTU's | Output BTU's |
|----------------|-------------|--------------|
| Residential | 4.00 | 4.77 |
| Commercial | 11.14 | 11.56 |
| Industrial | 5.05 | 4.79 |
| Transportation | 4.18 | 4.09 |
| Road | 5.16 | 5.15 |
| Rail | -2.62 | -2.40 |
| Air | 7.30 | 8.53 |
| Marine | 3.09 | 3.81 |
| TOTAL | 5.22 | 5.78 |

¹⁾ The totals differ from those shown in Table 1 since coke and coke oven gas are excluded from these calculations.

of retail trade, the price of energy relative to the CPI, the composition of the housing stock, and a measure of urbanization. Industrial energy requirements respond to the level of industrial real domestic product, the capital intensity of production and the price of energy relative to the price of industrial output. The specifications are shown in detail in the Appendix; the elasticities of energy demand with respect to activity and relative prices are given in Table 4 below.

Table 4.

| Sector | Activity Variable | Elasticity of energy demand with respect to: | |
|-------------|------------------------|--|-----------------|
| | | Activity | Relative Prices |
| Residential | real disposable income | .978 | -.316 |
| Commercial | volume of retail trade | .425 | -.473 |
| Industrial | real domestic product | .640 | -.587 |

A satisfactory specification has not yet been isolated for either total transportation or any of the four modes considered in the model. Work is still in progress on this front but for the moment our projections for transportation are made (in output BTU's) on the basis of judgmental assumptions with respect to total transportation requirements relative to total residential, commercial and industrial requirements. Further ratios are selected judgmentally to disaggregate total transportation requirements by mode.

Step 3: Projection

Projected values for the majority of the independent variables

are derived from a simulation of the CANDIDE econometric model.¹¹ Using the outputs from this system as inputs to the demand model increases the probability that the various projections for diverse quantity and price variables form a consistent set. Because of the nature of the demand model, the exogenous variables must be disaggregated by region. This is done by a set of assumed spreading ratios. For the purpose of sensitivity analysis, the user has the option of overriding the standard exogenous variable set with alternate assumptions about the national aggregates (made in the form of growth rate assumptions) and/or about the regional distribution for any or all national aggregates.

Step 4: Modification

This is an optional step which effectively allows the user to modify the levels of output BTU's projected within the system in a specified year. Modification is accomplished by specifying a percentage increase or decrease in the chosen years; values in intermediate years are appropriately adjusted automatically. This option reflects the desire to allow one to test for changes in the relationship of output BTU's to aggregate activity that one expects may occur but that cannot be statistically captured on the basis of observed experience. Such changes may result from such broad considerations as changes in insulation (or general building) standards to improve the energy efficiency of buildings; introduction of new technologies, such as heat pumps, district heating, rapid mass transit systems, etc.; or changes in preferences that may lead, for example, to reallocations of transportation demands among alternative modes.

Step 5: Disaggregation to a Fuel Basis

Having derived the projections of aggregate output BTU's for each end-use sector and region considered, and adjusted them if desired, it is necessary to convert them to projections of demands

¹¹See M.C. McCracken, "An Overview of CANDIDE Model 1.0 (CANDIDE Project Paper No. 1)" (Ottawa, Economic Council of Canada, 1973), pp. xii, 337.

for particular energy sources. The program contains standard assumptions as to the distribution of aggregate output PTU's among twelve different energy sources for each market considered. These assumptions, once again, can be easily modified by the user in two respects. In the first place one can specify market shares in any, or all, of the thirty-five markets for any, or all, years. Additionally, or alternatively, one has the option of specifying sets of price elasticities and projected price relatives, which will then be used to adjust the market shares. The adjustment is performed in the following manner. After the share matrices have been filled, the share of the specified fuel is further adjusted according to the relation

$$S_t = S_t^* \left\{ 1 + b \left[\frac{(t - T_0)}{(T - T_0)} \right] [(PR - 1.0)] \right\}$$

where

S_t is the adjusted share for the specified fuel in year t ;

S_t^* is the share for the specified fuel in year t resident in the share matrix (i.e. the share that would have obtained in the absence of the change in relative prices);

b is the assumed price elasticity (negative);

T_0 is the year prior to the year in which the relative price change is assumed to occur;

$T - T_0$ is the length of the adjustment period to the new equilibrium; and

PR is the assumed price relative.

Thus if $b = -.5$, $PR = 1.03$, $T_0 = 1980$ and $T = 1985$ then S_t will be reduced (relative to its unadjusted value) by

.3% in 1981,
 .6% in 1982,
 .9% in 1983,
 1.2% in 1984, and
 1.5% in 1985.

After the adjustment process is complete, the values of the share do not revert to the original matrix; the proportional adjustment is maintained at its last calculated values. In the previous example the share would be maintained beyond 1985 at 98.5% of the values that would otherwise have obtained, unless further adjustments are made. After the shares of specified fuels have been adjusted, the shares of substitute fuels are renormalized so that all shares sum to one.

In this exercise the user has the ability to specify, along with the market, fuel, elasticity and price relative, the nature of the substitution (i.e. whether a general substitution over all fuels or specific interfuel substitutions), the length of the adjustment process, and any absolute bounds to be placed on shares of specific fuels. It is possible to experiment with shifts in price relatives that are maintained for a long period or quickly reversed, and one can, as well, hypothesize adjustment periods that are asymmetrical with respect to price increases and decreases.

The design of the system in this way reflects the view that one of the crucial determinants of future energy demands is likely to be the nature and extent of interfuel competition. Work is underway to attempt to model past behaviour of market shares and eventually the system will be expanded to include the results of this exercise as a standard (or default) assumption. In the meantime, however, there is substantial scope to experiment with different assumptions about market shares and assess the relative importance of alternative market-development patterns.

Step 6: Conversion to Input BTU's

Having completed the step described above one converts the output BTU's by energy source back to input BTU's simply by dividing by the utilization efficiency factors. If one wishes to hypothesize future changes in these factors (to account, for example, for more efficient internal combustion engines) the option once again exists.

Step 7: Conversion from Secondary to Primary Energy

There are four conversion processes accounted for in the system: coal to coke; coal to electricity; oil to electricity; and natural gas to electricity. Aggregate demands for coke are not handled within the framework detailed above, but are rather projected independently. They are assumed to depend directly on real domestic product in the iron and steel industry. Once we have obtained a projection of coke requirements, an exogenous assumption about the relevant conversion efficiency is applied to convert the coke back to coal requirements.

Electricity is projected independently for each end-use sector and each region. To derive the demand for fossil fuels implicit in the projected level of electricity generation we first aggregate electricity over all end-uses, then gross up the amount calculated to account for energy supply industry demands (transmission losses). To these aggregate time series we apply a series of ratios (different for each region of Canada) to split BTU's of electricity generated into four modes: coal, oil, gas, and nuclear and hydro. The number of BTU's generated by each of the fossil fuels considered is then scaled by the assumed efficiency of the conversion process to produce estimates of BTU's of coal, oil and gas required.

There are three sets of assumptions required in this step:

- a) estimates of energy supply industry demands for electricity as a percentage of total other generation;
- b) estimates of the distribution among fuel sources of electricity generation; and
- c) estimates of the efficiencies of the four conversion processes considered.

The latter two sets of assumptions vary regionally but the former does not. All of these assumptions may be easily modified by the user.

At the moment, the program does not consider the generation of synthetic natural gas from coal, or the use of electricity to produce either hydrogen or hydrocarbons. Modifications can be made, however, if such are deemed desirable.

Finally, after these seven basic steps have been completed the determination of the total requirements of the energy supply industries is arrived at. The demands for electricity of the energy-supply industries are derived in the steps described above. Demands for coal, oil and gas are estimated by applying appropriate proportional adjustments¹² to total other primary energy demands, including energy delivered to final consumers, energy used to fuel thermal electric plants, and the demands for oil and natural gas used as feedstocks. The non-energy use of oil and gas is projected, as are coke requirements, outside the basic framework here presented.

2.4 Summary and Overview

This section has presented an analytical framework in which demands for energy can be consistently assessed under widely varying sets of basic assumptions. The schema is shown graphically in Figure 1 for a prototype end-use sector consuming three energy sources, one of which is produced as secondary energy from inputs of the other two. Technology and relative prices enter explicitly at the points designated A, B, C and D in the following ways:

Point A. At this point we use the utilization efficiency factors to convert input BTU's to output BTU's.

Point B. Given a projection of output BTU's for a sector we must determine the shares of each energy source in the provision of those output BTU's. There are technological constraints on the scope and timing of various interfuel substitution possibilities and relative price projections can be assumed to influence

¹²The framework developed does not yet specifically take account of production, imports and exports. Assumptions about these ratios, therefore, implicitly embody assumptions about trade in energy products, and this should be noted.

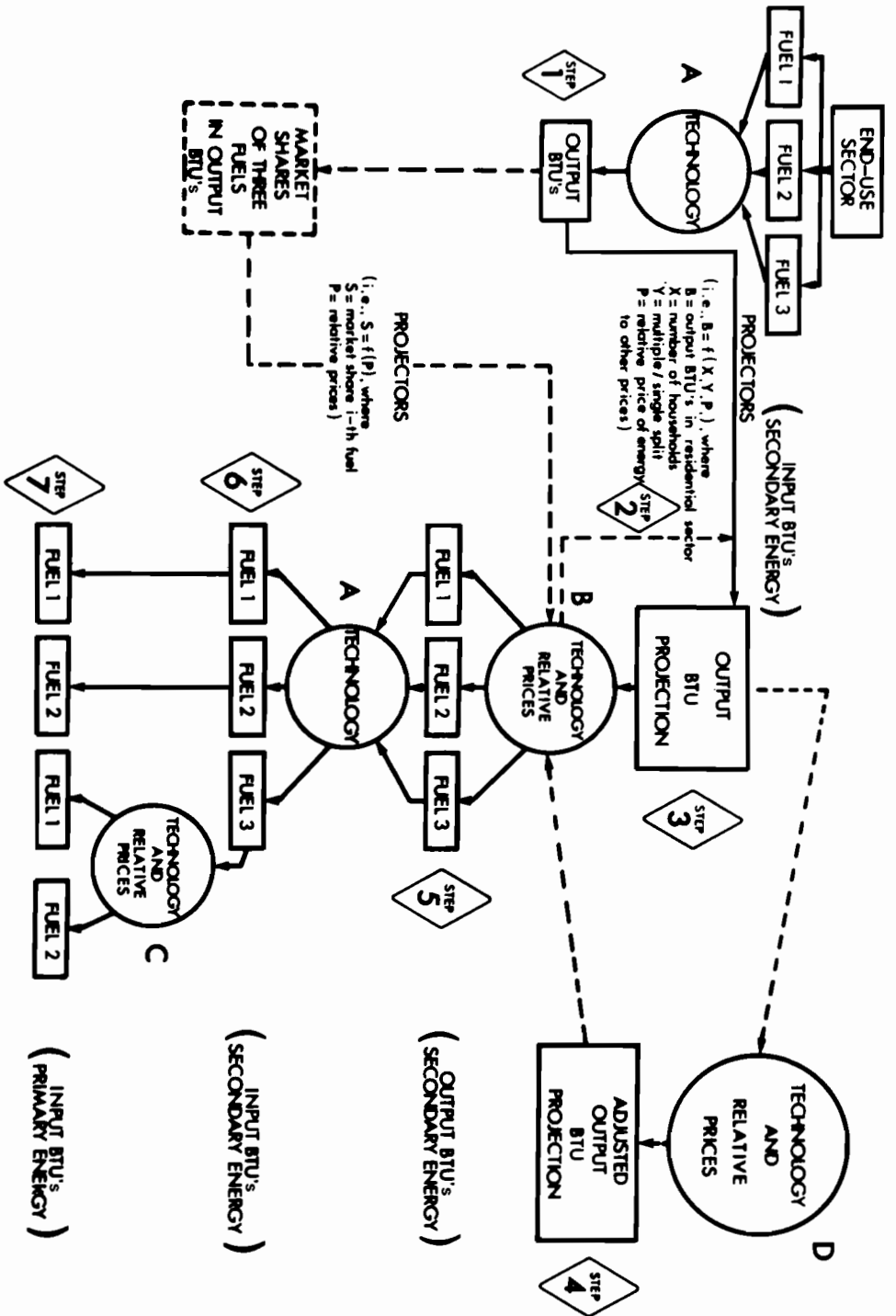

Figure 1.

speeds of adjustment to technologically determined market shares. Having determined market share scenarios one reconverts, using projected utilization efficiencies--Point A again--from output to input BTU's.

Point C. At this point conversions from secondary to primary energy are detailed. This process depends on projections of various modes of secondary energy supply and related conversion efficiencies--again determined by technology and relative prices.

Point D. The projectors themselves are fairly simplistic regression equations linking output BTU's by sector and region to aggregate activity variables and relative prices. If it is believed that the projectors fail to mirror the full range of possible changes in energy use owing to increased conservation practices or more energy-efficient technologies, one can make explicit adjustments to the projection of output BTU's. This process is shown in dashed lines in the upper right of Figure 1.

Finally, as a logical and desirable extension of the model, one can attempt to quantify the effects of relative prices on market shares as indicated in the lower left portion of Figure 1. Again, projections made in this manner would have to be consistent through time with feasible technology sets, as postulated at Point B. A more complete description of the structure of the model, the nature of the default assumptions, the computer program itself, and the user-oriented options are available upon request.

3. Some Alternative Projections

Three alternative scenarios for the future evolution of Canadian energy requirements are presented in Tables 5, 6 and 7. Each of these projections has been generated by the framework described in the preceding section and is characterized by the following sets of assumptions.

Case A. In this case the exogenous variables describing the evolution of Canadian demographic and economic events were drawn from a solution of the CANDIDE econometric model. It was

Table 5. Characteristics of three energy demand scenarios, 1980.

| | <u>Case A</u> | <u>Case B</u> | <u>Case C</u> |
|--|---------------|---------------|---------------|
| <u>Trillions BTU</u> | | | |
| Primary energy | 9,121 | 9,219 | 10,370 |
| Secondary energy | 6,478 | 6,553 | 7,400 |
| <u>Percent</u> | | | |
| <u>Source distribution (primary)</u> | | | |
| coal | 8.7 | 8.8 | 8.5 |
| oil and gas | 63.8 | 63.7 | 63.5 |
| primary electricity ¹⁾ | 27.5 | 27.5 | 27.9 |
| secondary electricity ¹⁾ | 7.8 | 7.8 | 7.8 |
| <u>Use distribution (secondary)</u> | | | |
| residential | 18.7 | 18.1 | 18.1 |
| commercial | 18.2 | 18.4 | 17.3 |
| industrial | 26.1 | 26.4 | 27.4 |
| transportation | 25.4 | 25.3 | 25.5 |
| energy supply | 11.7 | 11.7 | 11.7 |
| <u>Indexes (1970 = 100)</u> | | | |
| Primary energy/capita | 124.0 | 121.9 | 137.1 |
| Primary energy/GNE | 84.7 | 84.8 | 94.6 |
| <u>Average annual growth rates (1971-1980)</u> | | | |
| Primary energy | 3.5 | 3.6 | 5.0 |
| Secondary energy | 3.1 | 3.2 | 4.6 |
| Primary energy/capita | 2.2 | 2.0 | 3.3 |
| Primary energy/GNE | -1.6 | -1.6 | -0.4 |

¹⁾ Primary electricity consists of hydro and nuclear; secondary electricity consists of that generated from fossil fuels.

Table 6. Characteristics of three energy demand scenarios, 1985.

| | <u>Case A</u> | <u>Case B</u> | <u>Case C</u> |
|--|---------------|---------------|---------------|
| <u>Trillions BTU</u> | | | |
| Primary energy | 11,204 | 11,764 | 13,152 |
| Secondary energy | 7,786 | 8,209 | 9,218 |
| <u>Percent</u> | | | |
| <u>Source distribution (primary)</u> | | | |
| coal | 8.0 | 8.3 | 8.0 |
| oil and gas | 61.8 | 61.6 | 61.4 |
| primary electricity ¹⁾ | 30.1 | 30.1 | 30.5 |
| secondary electricity ¹⁾ | 6.8 | 6.9 | 7.0 |
| <u>Use distribution (secondary)</u> | | | |
| residential | 17.1 | 16.3 | 16.3 |
| commercial | 18.5 | 19.2 | 18.0 |
| industrial | 26.1 | 26.2 | 27.3 |
| transportation | 25.7 | 25.7 | 25.8 |
| energy supply | 12.6 | 12.5 | 12.5 |
| <u>Indexes (1970 = 100)</u> | | | |
| Primary energy/capita | 143.0 | 142.4 | 159.2 |
| Primary energy/GNE | 86.0 | 84.3 | 94.3 |
| <u>Average annual growth rates (1971-1985)</u> | | | |
| Primary energy | 3.8 | 4.1 | 5.0 |
| Secondary energy | 3.3 | 3.7 | 4.6 |
| Primary energy/capita | 2.4 | 2.4 | 3.2 |
| Primary energy/GNE | -0.9 | -1.1 | -0.3 |

¹⁾ Primary electricity consists of hydro and nuclear; secondary electricity consists of that generated from fossil fuels.

Table 7. Characteristics of three energy demand scenarios, 1990.

| | <u>Case A</u> | <u>Case B</u> | <u>Case C</u> |
|--|---------------|---------------|---------------|
| <u>Trillions BTU</u> | | | |
| Primary energy | 13,475 | 14,914 | 16,592 |
| Secondary energy | 9,155 | 10,224 | 11,432 |
| <u>Percent</u> | | | |
| <u>Source distribution (primary)</u> | | | |
| coal | 7.3 | 7.8 | 7.6 |
| oil and gas | 60.1 | 59.7 | 59.6 |
| primary electricity ¹⁾ | 32.6 | 32.6 | 32.9 |
| secondary electricity ¹⁾ | 5.8 | 5.9 | 6.0 |
| <u>Use distribution (secondary)</u> | | | |
| residential | 16.4 | 14.7 | 14.8 |
| commercial | 17.9 | 19.7 | 18.3 |
| industrial | 26.1 | 26.3 | 27.5 |
| transportation | 26.1 | 26.0 | 26.2 |
| energy supply | 13.4 | 13.3 | 13.2 |
| <u>Indexes (1970 = 100)</u> | | | |
| Primary energy/capita | 161.9 | 164.8 | 183.3 |
| Primary energy/GNE | 87.4 | 83.4 | 92.8 |
| <u>Average annual growth rates (1971-1990)</u> | | | |
| Primary energy | 3.8 | 4.3 | 4.9 |
| Secondary energy | 3.3 | 3.9 | 4.5 |
| Primary energy/capita | 2.5 | 2.5 | 3.1 |
| Primary energy/GNE | -0.6 | -0.8 | -0.3 |

¹⁾ Primary electricity consists of hydro and nuclear; secondary electricity consists of that generated from fossil fuels.

also assumed that energy prices would continue to increase in real terms until the late seventies, with the price of oil in Canada reaching a level of \$9.00/bbl. (in 1974 dollars) at the wellhead in 1978. It should also be noted that the energy prices used in generating the macroeconomic projection were roughly consistent with this scenario.

Case B. Case B examines what might occur if future energy prices behave as in Case A, if demographic and economic variables continue to grow through the next fifteen years at the average annual rates experienced in the decade of the sixties.

Case C. In this scenario it is also assumed that the demographic and economic experience of the next fifteen years will mirror the experience of the sixties. In addition, however, it is further assumed for illustrative purposes that the events of 1973 did not in fact occur and that energy prices continue to 1990 at their 1971 values in real terms. In one sense, Case C may be viewed as a "high benchmark" experiment, although the fact that relative energy prices are assumed constant in real terms, rather than continuing to decline as they did in the sixties suggests that even the Case C results are lower than results one would attain by simply extrapolating the 1960's experience. A brief quantitative record of the major assumptions characterizing the three cases examined is given in Table 8.

The differences in energy demands by 1990 among these three scenarios is substantial. The combination of higher economic growth and lower energy prices simulated in Case C induce a primary energy requirement in 1990 that is 3,100 trillion BTU's greater than Case A. This difference is significant, amounting to the equivalent of 1.4 million barrels of crude oil per day, or more than the output of ten Syncrude-sized oil sands plants. A comparison with Case B indicates that of the 3,100 trillion BTU difference in 1990; about 54% is attributable to the higher price assumptions, while roughly 46% occurs because lower rates of population increase induce lower rates of growth of economic activity generally.

Table 8. Major assumptions underlying three energy demand scenarios.

| | 1973 Value | Average annual growth rates (%) | | | |
|--|---------------|---------------------------------|---------|---------|---------|
| | | 1960-70 ²⁾ | 1974-80 | 1981-85 | 1986-90 |
| Gross Nation Expenditure (GNE) (\$1961 billions) | 76.3 | 5.2 | 4.9 | 3.9 | 3.4 |
| Population (millions) | 22.1 | 1.8 | 1.3 | 1.3 | 1.2 |
| Households (millions) | 6.5 | 2.9 | 2.7 | 2.4 | 1.6 |
| Unemployment ¹⁾ Rate (%) | 6.5 | 5.2 | 5.0 | 5.3 | 5.6 |
| Consumer Price Index (1961 = 100) | 150.4 | 2.7 | 6.0 | 4.5 | 4.5 |
| Ratio of Multiple ¹⁾ Dwellings to Total Housing Stock (%) | 41.3 | 36.3 | 43.0 | 44.8 | 45.3 |

1) Average value shown rather than average annual growth rate.

2) These are the growth rates used in Cases B and C.

An additional point to note is that the average annual growth rates for primary energy and primary energy/capita from all three simulations are considerably lower than the historical experience of the sixties. In that decade, with energy prices declining in real terms, primary energy grew at about 5.5% per year while primary energy/capita grew at 3.6% per year.

Although a number of problems in interpretation persist, the ratio of primary energy consumption per dollar of GNE is frequently alluded to as a measure of the efficiency with which energy is used. In a very gross sense this measure represents the inverse of a standard productivity calculation, although over long periods of time sectoral shifts in both the numerator and the denominator can confound interpretation. Examining Cases B and C for example, it appears that with constant real energy prices (although at differing levels) and a continuation of the 1960's structural composition of economic activity the implicit elasticity of total primary energy requirements with respect to GNE is slightly less than unity.¹³ On the other hand the economic scenario used in Case A (which contains the same prices as Case B) results in an increasing primary energy/GNE ratio. The explanation of this phenomenon must be sought in structural differences in the two economic scenarios. One possible explanation is that the macroeconomic projection in Case A is marked by a trend to smaller and smaller households. Since residential energy consumption varies with the number of households a decline in household size would lead to greater energy use for a given population.

The main point to bear in mind in all of this is that the nature of the "macro" assumptions can significantly affect the results. If rational planning is to be carried on, one requires

¹³The fact that the observed ratio of primary energy requirements to GNE rose from 1960-1970 may be interpreted as owing to the additional energy consumption effects of falling real prices for energy. It should be pointed out, as well, that neither GNE nor population in fact enters the demand model explicitly.

not only a projection of what energy demands are likely to be with a given set of assumptions, but also a clear appreciation of the sensitivity of the results to changes in those assumptions.

In addition to the "macro-simulations" reported in Tables 5, 6 and 7, three "micro-simulations" were also conducted with the model. In each of these three simulations we adopted Case A as our "control" and examined the effects on energy consumption of a specific change to one of our assumptions. In particular, we hypothesized:

- 1) an increase of 40% in the efficiency of the internal combustion engine, achieved by 1980;
- 2) an increase of 25% in the efficiency of light fuel oil residential furnaces, achieved by 1980; and
- 3) an increase in the percentage of the housing stock consisting of multiple dwellings, from 41% in 1973 to 48% by 1980 and 60% by 1990.

The results of these simulations, all expressed in terms of percentage reductions from the demand levels suggested by Case A, are presented in Table 9.

The increase in engine efficiency leads to a reduction in energy consumption of about 20% in the transportation sector in 1980 and about 19% in 1990. These numbers represent about 170,000 barrels of oil per day in 1980 (235,000 barrels/day by 1990). The fact that the "transportation saving" decreases slightly from 1980 to 1990 in relative terms is attributable to the relatively slower growth assumed for road transportation within the sector.

The energy reductions generated by an increase in the efficiency of residential oil-burning furnaces are substantially smaller, amounting in 1980 to less than 30% of the reductions attributable to increased engine efficiency and in 1990 to less than 20% of these savings. From 1980 to 1990 the amount of energy saved by this technological change falls absolutely as

Table 9. Possible reductions in energy requirements attending three specific microscenarios.

| | Levels of Energy Demand (Case A) (BTU Trillions) | | Percentage Reduction in Energy Demands | | | | | |
|-------------------------------------|---|---------|--|--------|------------------------------------|------|------|-------|
| | 1980 | 1990 | Increase engine efficiency | | Increase LFO conversion efficiency | | | |
| | 1980 | 1990 | 1980 | 1990 | 1980 | 1990 | | |
| <u>Secondary Energy</u> | | | | | | | | |
| Residential | 1,209 | 1,502 | - | - | 7.6 | 5.4 | 12.1 | 40.6 |
| Commercial | 1,176 | 1,643 | - | - | - | - | -6.5 | -20.7 |
| Industrial | 1,689 | 2,390 | - | - | - | - | - | - |
| Transportation | 1,644 | 2,391 | 19.7 | 18.6 | - | - | - | - |
| (Road Transport) | (1,219) | (1,697) | (26.6) | (26.2) | (-) | (-) | (-) | (-) |
| Energy Supply | 759 | 1,229 | 3.4 | 4.0 | 0.9 | 0.7 | 1.2 | 3.1 |
| Total Secondary Energy | 6,477 | 9,155 | 5.4 | 5.4 | 1.5 | 1.0 | 1.2 | 3.4 |
| Total Primary Energy | 9,121 | 13,475 | 3.8 | 3.7 | 1.1 | 0.7 | 1.1 | 3.6 |
| Total Oil Consumption ¹⁾ | 4,085 | 5,460 | 8.6 | 9.0 | 2.4 | 1.7 | 2.1 | 2.4 |
| Total Other Fuels ¹⁾ | 3,368 | 5,123 | - | - | - | - | 1.0 | 3.9 |

¹⁾ Total oil consumption is roughly equivalent to 2.0 million barrels/day in 1980, 2.6 million barrels/day in 1990. Total fuels used is equal to total secondary energy plus conversion losses in the production of electricity plus non-energy use of energy products.

well as relatively. In the context of the model, this is attributable to the increasing substitution of natural gas and electricity for residential space heating.

Finally, it can be seen from the third simulation reported in Table 9 that the acceleration of the trend to multiple dwellings reduces total primary energy consumption (by 100 trillion BTU's in 1980 and 485 trillion BTU's in 1990), although decreases in the residential sector are offset by increases in the commercial sector. This phenomenon reflects the fact that our structural representations of energy demand in these two sectors incorporate the purely statistical practice of classifying as commercial consumption all energy purchased at "commercial rates," including that for large multiple dwellings. The reduction in the demand for oil represents about 72% of the total energy reduction in 1980 falling to 40% in 1990 as the increase in the trend to multiple dwellings accelerates the reduction in the share of oil used for space heating.

4. Conclusions

The analytical framework presented here represents the beginning of an attempt to examine energy demand projections in a consistent and rigorous fashion. It explicitly recognizes the dependence of energy consumption on the consumption of other goods and services and the importance of examining the use of particular energy commodities in the context of a demand for total energy linked to demographic and economic activity. The roles that relative prices and technology play in influencing energy demands are highlighted in a manner that facilitates sensitivity analysis. The simulations presented in Section 3 indicate that the tool is potentially useful in both a "macro" and a "micro" context.

Although the framework itself is conceptually sound, it would be presumptuous to claim that, in its current state of development, it is satisfactory or that the simulation results can be accepted with a great degree of confidence. Research is proceeding in a number of areas, chief among which are:

- a) the development of a structural representation for energy demands in the transportation sector and sub-sectors;
- b) econometric modelling of market shares;
- c) further disaggregation of the industrial sector, to include structural models of the major energy-intensive industries; and
- d) extension of the number of conversion processes considered, specifically to include coal gasification.

The process of modelling the evolution of market shares is almost completed and will remove a major inconsistency within the framework. At the present time assumptions are made about aggregate energy prices, and these prices do not adjust with hypothesized shifts in market shares. Ultimately we will proceed by assuming price profiles for individual energy commodities, with aggregate prices determined simultaneously with market shares. Completion of this phase will result in a more fully integrated framework.

As it stands, we have found the framework presented here useful for systematizing our thoughts about how the demand for energy evolves, in forcing us to be explicit about our assumptions, and in providing a focus to our analytical investigations. In attempting to read such a long way into the future I would suggest that this is all one can, and indeed should, expect from any model.

APPENDIX

Structural Representations of Residential,
Commercial and Industrial Energy Consumption

The equations presented below have all been estimated by ordinary least squares (OLS) and, because of the limited number of observations available, data have been pooled so that each equation consists of a time series of five cross sections. The absolute value of the t-statistic is shown below each coefficient. Below the equation are recorded the number of degrees of freedom (DF), the adjusted coefficient of multiple determination (R^{-2}), and the coefficient of variation (COV). A further table presents summary statistics, derived from an analysis of residuals, for each of the five regions and for Canada.

1. Residential Sector

Preferred Residential Equation 1958-1971

$$\begin{aligned} \ln (\text{OBTUR}/\text{HOHO}) = & -10.272 \text{ DUM1} - 9.5090 \text{ DUM2} \\ & (7.56) \qquad \qquad \qquad (6.78) \\ & -9.7375 \text{ DUM3} - 10.2494 \text{ DUM4} \\ & (6.92) \qquad \qquad \qquad (7.41) \\ & -10.576 \text{ DUM5} + .69720 \ln \text{ DD} \\ & (7.58) \qquad \qquad \qquad (4.66) \\ & +.97834 \ln (\text{YPD}/(\text{PCPI}*\text{HOHO})) \\ & (6.08) \\ & -.31556 \ln (\text{PENR}/\text{PCPI}) \\ & (2.34) \\ & +1.4073 \ln (\text{STS}/(\text{STS}+\text{STM})) \\ & (4.69) \\ & +1.0598 \ln (\text{STS}/(\text{STS} + \text{STM})) * \text{DUM3} \\ & (2.48) \end{aligned}$$

DF = 60 $R^{-2} = .934$ COV = -1.87%

The five variables, DUM1 to DUM5, are regional intercepts for the Atlantic, Quebec, Ontario, Prairies, and B.C. regions, respectively. The remaining variables are defined below.

OBTUR = Trillions of output BTU's, residential sector;

HOHO = Thousands of households;

YDP = Personal disposable income, millions of \$;

PENR = Price of energy, residential sector, 1.0 in 1961;

PCPI = CPI deflator, 1.0 in 1961;

STS = Stock of single houses, thousands;

STM = Stock of multiple houses, thousands, and

DD = Degree days.

Table 10. Residual analysis of residential energy demands 1958-1971.

| | Atlantic | Quebec | Ontario | Prairies | B.C. | Canada |
|--------------------------------|----------|--------|---------|----------|------|--------|
| R ² | .972 | .964 | .904 | .960 | .962 | .965 |
| Durbin/Watson | .59 | 1.47 | .87 | 1.64 | .76 | .76 |
| Ave. Absolute Percentage Error | 2.75 | 3.19 | 3.38 | 2.38 | 3.57 | 2.82 |

2. Commercial Sector

Preferred Commercial Equation 1961-1971

$$\begin{aligned}
 \text{OBTUC} = & -80.670 \text{ DUM1} - 203.37 \text{ DUM2} - 189.28 \text{ DUM3} \\
 & (2.00) \qquad (4.95) \qquad (4.73) \\
 & -58.419 \text{ DUM4} - 99.866 \text{ DUM5} \\
 & (1.51) \qquad (2.40) \\
 & +.00859 \text{ RTR} + 223.46 \text{ LAB} \\
 & (1.72) \qquad (3.32)
 \end{aligned}$$

$$\begin{aligned}
 & -38.988 \text{ PENIC/PCPI} \\
 & \quad (1.99) \\
 & +.16625 \text{ (STM/(STS + STM)) * (HOHO)} \\
 & \quad (2.39) \\
 & +.12996 \text{ (STM/(STS + STM)) * (HOHO) * (DUM3)} \\
 & \quad (2.41) \\
 & +6.2480 \text{ (TIME) * (DUM2)} \\
 & \quad (4.76)
 \end{aligned}$$

$$\text{DF} = 44 \qquad R^{-2} = .990 \qquad \text{COV} = 7.00\%$$

The definitions of the relevant variable are:

OBTUC = Trillions of output BTU's, commercial sector;

RTR = Retail trade (deflated by PCPI), millions of \$1961;

STS = Stock of single houses, thousands;

STM = Stock of multiple houses, thousands;

PENIC = Proxy for price of energy to commercial consumers, calculated by weighting implicit price indices for fuel oil, natural gas and electricity in manufacturing by commercial sector distribution of these fuels;

PCPI = Consumer price index, 1961 = 1.0;

LAB = Proportion of total employment in trade, finance, public administration and services;

HOHO = Thousands of households; and

TIME = Time trend equal to 1.0 in 1958.

Table 11. Residual analysis of commercial energy demands 1961-1971.

| | Atlantic | Quebec | Ontario | Prairies | B.C. | Canada |
|--------------------------------|----------|--------|---------|----------|-------|--------|
| R^2 | .949 | .984 | .980 | .945 | .799 | .999 |
| Durbin/Watson | 2.20 | 1.62 | 1.96 | .71 | .70 | 2.74 |
| Ave. Absolute Percentage Error | 5.79 | 4.45 | 4.21 | 4.63 | 15.13 | 1.05 |

3. Industrial SectorPreferred Industrial Equation 1961-1971

$$\begin{aligned} \ln \text{OBTUI} = & -1.2659 \text{ DUM1} - .64113 \text{ DUM2} \\ & (4.52) \quad (1.71) \\ & - .78095 \text{ DUM3} - 1.2002 \text{ DUM4} \\ & (2.02) \quad (4.08) \\ & -1.2695 \text{ DUM5} + .63962 \ln \text{RDPI} \\ & (4.39) \quad (10.73) \\ & + .29761 \ln (\text{K/L}) \\ & (4.12) \\ & - .58735 \ln (\text{PENI/POI}) \\ & (6.96) \end{aligned}$$

$$\text{DF} = 47 \quad R^{-2} = .997 \quad \text{COV} = .81\%$$

The variables are defined as follows:

OBTUI = Output BTU's demanded in the industrial sector, trillions of BTU's;

RDPI = Real domestic product in the industrial sector, millions of \$1961;

K = Capital stock in industrial sector, millions of \$1961;

L = Employment in the industrial sector, thousands of persons;

PENI = Implicit deflator for output BTU's purchased by industrial sector, 1961 = 1.0; and

POI = Price of output, industrial sector, 1961 = 1.0.

Table 12. Residual analysis of industrial energy demands 1961-1971.

| | Atlantic | Quebec | Ontario | Prairies | B.C. | Canada |
|--------------------------------|----------|--------|---------|----------|------|--------|
| R^2 | .927 | .923 | .980 | .988 | .972 | .994 |
| Durbin/Watson | 1.26 | 1.25 | 2.13 | 1.59 | 2.35 | 1.59 |
| Ave. Absolute Percentage Error | 4.65 | 2.29 | 1.96 | 1.76 | 3.22 | 1.13 |

The Demand for Energy Imports and Energy Independence

D. Newlon

Reduced dependence on foreign sources supposedly reduces the short-run vulnerability of importing nations and decreases the long-run cost of energy. The difference between the competitive price of oil and its current price presumably reflects the monopoly power of the cartel of oil-producing nations.¹ Many analysts have recommended increased energy independence for oil consuming nations as a way of driving down world oil prices toward competitive levels. Oil imports have been repeatedly interrupted in the past for other reasons. The cost of a sudden interruption in imports is much greater than the cost of gradually adjusting to a reduced level of imports. Therefore, insurance against an interruption in imports can justify some level of energy independence.²

Policies to achieve energy independence can be grouped into three broad categories. Most policies affect energy dependence by reducing the demand for imports. The first

¹"In the period since 1970, the royalty component has risen dramatically. At January 1974 posted prices, the royalties for most Mideast countries are about \$7.00 per barrel--seven times the 1970 levels. These are almost twenty-five times the efficiency royalties.... From the quantitative evidence presented here, most of the divergence of market price from the long-run competitive supply price appears attributable to government restrictions (oil import quotas and prorationing) and to excessive payments to producing countries." W.D. Nordhaus, "The Allocation of Energy Resources," Brookings Papers on Economic Activity, Vol. 3, 1973, pp. 558-559.

²K. Areskouj, "U.S. Oil Import Quotas and National Income," Southern Economic Journal, 37 (January 1971), 307-317.

category consists of policies that decrease the demand for imports such as tariffs, import quotas, mandatory and voluntary conservation measures, subsidies for substitutes for foreign energy sources, and relaxation of environmental constraints on the use of domestic substitutes.

The second category of policies achieves energy independence by bridging the gap between the long- and the short-run. For example, the depletion of oil stores held above or below ground to replace interrupted oil imports could give the economy time to adjust to an interruption of imports or supplement existing imports and domestic energy sources until the interruption has passed.

Policies drawn from these two categories have been extensively analyzed.³ The executive branch and Congress of the United States are currently locked in a dispute about which of these policies should be used to achieve energy independence. But there is a third, neglected, category of policies which do not appear in government, academic, or industry studies of energy policies. Adoption of these proposals would increase the sensitivity of the demand for foreign imports to changes in the world price.

The French government has a policy of reducing imports by quota whenever the oil price increases so as to keep the total amount paid for the French oil imports constant. This "price dependent" quota, our third policy category, could be used to confront the oil cartel with a demand for their exports that was price-elastic. A similar effect would

³The following are two of the many recent studies on energy policy: Federal Energy Administration Project Independence, Government Printing Office, November 1974. D. Freeman, ed., A Time to Choose-America's Energy Future (Cambridge, Massachusetts, Ballinger Publishing Co., 1974).

come from a tariff that matched increases in price with increases in the size of the tariff.⁴ Steps that increase the availability of substitutes for energy imports could be conditional on the world oil price. The rate at which tracts are leased on the US outer continental shelf could be contingent on the world oil price with increases in the price of oil accelerating the rate at which tracts are leased, while decreases could cause leasing to slow or even stop.

It is the contention of this paper that the policies in the third category are potentially as or more attractive than the policies in the first two categories. It is also possible that reducing demand can be counterproductive. A quota or a tariff that reduces imports could increase vulnerability to short-run dislocations and raise the long-term cost of energy.

This paper presents a simple yet plausible illustrative example of the effects of different policies on the world oil price, and on the vulnerability of oil-importing nations to short-run dislocations in the oil supply, in order to demonstrate the potential superiority of increasing the sensitivity of the demand for energy imports to price changes and the dangers in decreasing the demand for imports. The demand for energy imports and also the marginal benefits from these imports are represented by equation (1):

$$Q = b - aP$$

where

(1)

$$b > 0 \text{ and } a \geq 0 .$$

⁴I would like to thank Arnold Packer for this suggestion.

They are represented by D in Figure 1. Let Q^* and P^* represent respectively the long-run equilibrium rate of imports and world price.

In shifting along the short-run instead of the long-run demand for energy imports, a given change in price causes a smaller change in consumption or

$$a' = (Q^* - Q)/(P - P^*)$$

where

$$a' = ak \quad ,$$

$$k \leq 1 \quad .$$

This can be rewritten as $ak(P - P^*) = Q^* - Q$. Substituting for Q^* from equation (1), the short-run demand for energy from foreign sources will be

$$Q = b - a(1 - k)P^* - kaP \quad . \quad (2)$$

We will assume that the short-run demand for imports from foreign sources coincides with the marginal benefits from foreign energy imports.

Each of the three sets of policies can be described by changes in a single parameter in this example. In Figure 2 the demand for imports from foreign sources shifts away from the long-run marginal benefit curve due to a quota, tariff, subsidies for domestic substitutes, or forced conservation. Algebraically, the value of b decreases. In Figure 2B the increase in emergency oil storage and improved preplanning twists the short-run demand and marginal benefit curve toward the long-run demand. Algebraically, these policies increase the value of k . In Figure 2C the sensitivity to the world price increases through a price dependent quota

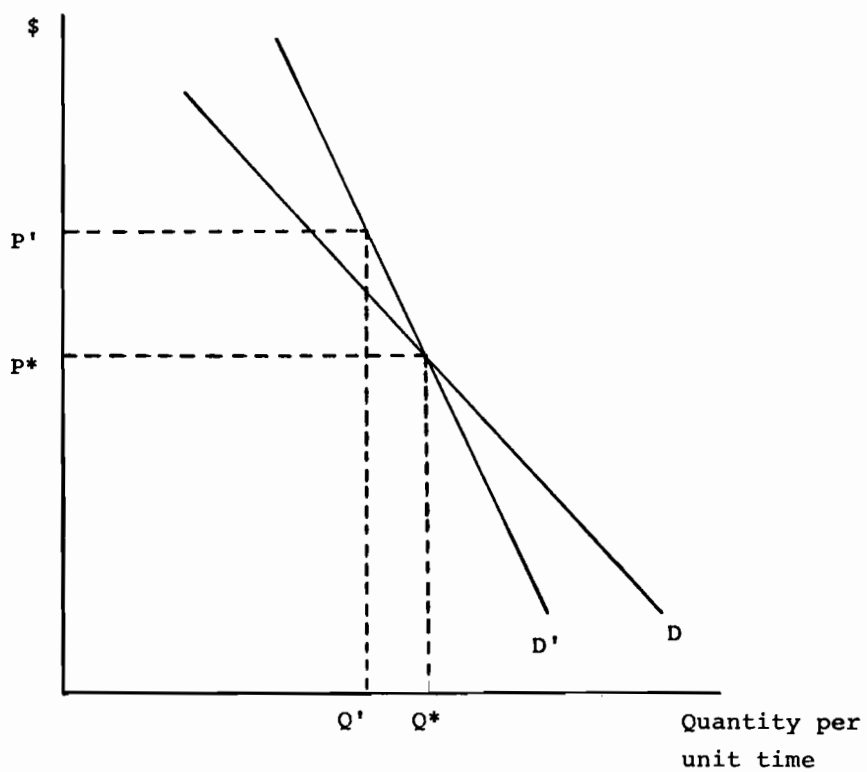

Figure 1. Long-run and short-run demand and marginal benefit curves.

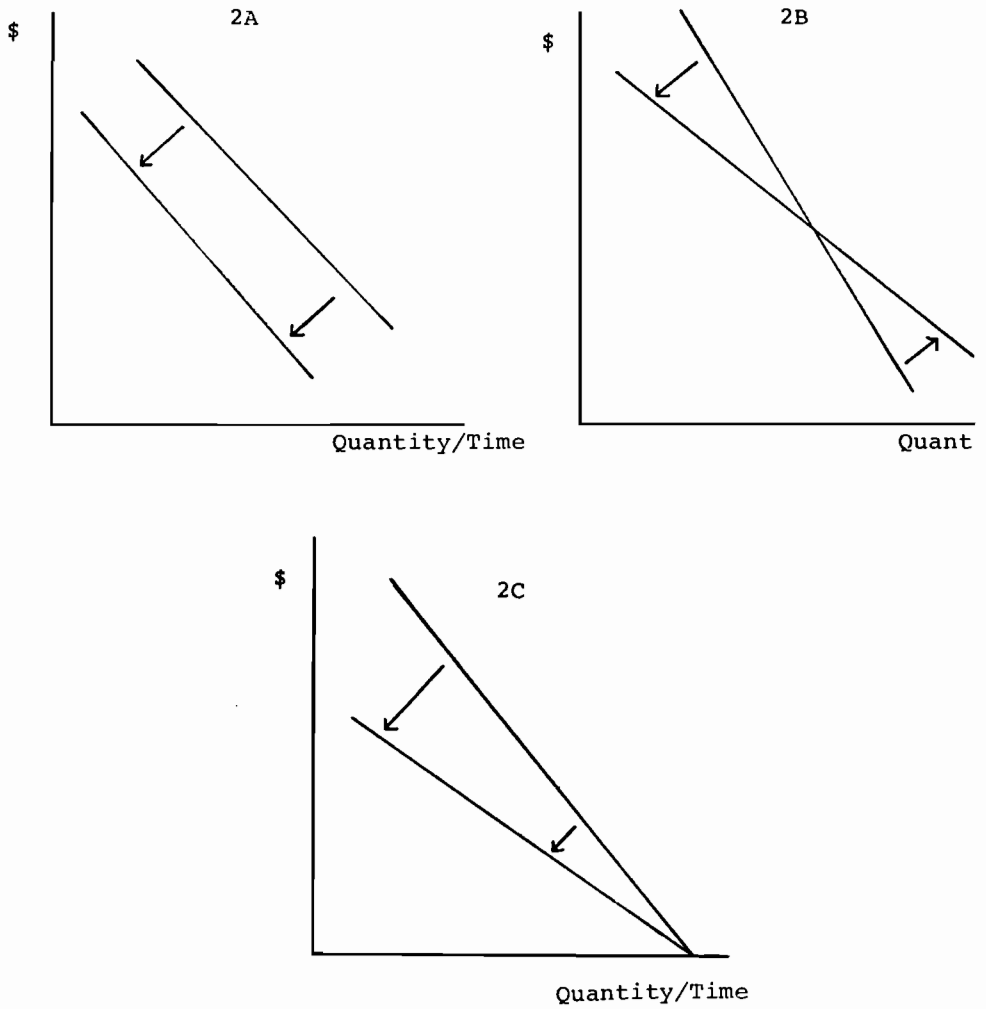

Figure 2. Effect of different policies.

or tariff. The slope of the demand for imports increases although the intercept remains the same. Algebraically, the value of a increases.

Energy independence is supposed to reduce the long-run price of oil by blunting the power of the cartel of foreign producers. This effect can be represented by a decrease in the value of P^* . If the policy decreases vulnerability to short-run disruptions, then the equilibrium short-run price P' should decrease. The cost of these policies will be reflected by their effects on Q^* and Q' , respectively the long and short-run equilibrium rates of energy imports.

Assume that the cartel maximizes revenue in the long-run. The revenue of the cartel will be $RL = P Q$. The first order conditions for a maximum will be

$$\frac{\partial RL}{\partial P} = P^* \frac{\partial Q}{\partial P^*} + Q^* = b - 2aP^* = 0 \quad .$$

The revenue maximizing price will be:

$$P^* = b/2a \quad . \quad (3)$$

From equations (1) and (3) the equilibrium consumption will be

$$Q^* = b/2 \quad . \quad (4)$$

From equations (2) and (3) the short-run demand for imports will be

$$Q = \frac{b(1+k)}{2} - kaP \quad . \quad (5)$$

Assume that periodically the cartel takes advantage of the inelasticity of the short-run demand to raise the price of

oil above the long-run price. Let the revenue in the short-run be $RS = P Q$ and the first order condition for a maximum will be

$$\frac{\partial RS}{\partial P} = P \frac{\partial Q}{\partial P} + Q' = \frac{b(1+k)}{2} - 2kaP' = 0 \quad .$$

Solving for P' and substituting from equation (3):

$$P' = P^*(1 + 1 + 1/k)/2 \quad . \quad (6)$$

As would be expected, the short-run price is always equal to or larger than the long-run price, since $k \leq 1$. From equations (4), (5), and (6), if the cartel maximizes its revenue in the short-run, the rate of consumption of energy from foreign sources will be:

$$Q' = Q^*(1 + k)/2 \quad . \quad (7)$$

The effects of the different policies on Q^* , Q' , P^* , and P' can be found by differentiating equations (3), (4), (6), and (7) by a , b , and k .

Decreasing the demand for energy imports lowers long and short-run prices at the cost of less long and short-run consumption of imports, since

$$\partial P^*/\partial b = 1/2a > 0; \quad \partial Q^*/\partial b = 1/2 > 0 \quad ;$$

$$\partial P'/\partial b = (1 + 1/k)/4a > 0 \quad ; \quad \text{and}$$

$$\partial Q'/\partial b = (1 + k)/4 > 0 \quad .$$

Bridging the gap between the long and short-run demand will reduce the short-run price and the short-run consumption without affecting long-run prices or consumption because,

$$\partial P' / \partial k = -P^* / 2k^2 < 0; \quad \partial Q' / \partial k = Q^* / 2 > 0 \quad .$$

Policies that reduce short-run vulnerability have other costs associated with them. Maintaining enough inventories to cover an interruption in imports requires a sizable investment in order to accumulate the stores of oil and to construct facilities in which to store the oil. There is also a significant carrying cost associated with inventories and a cost to utilizing the inventories in an emergency.

Increasing the sensitivity of the demand for imports lowers both the short- and long-run prices with no decrease in either short- or long-run consumption, since

$$\partial P^* / \partial a = -b / 2a^2 < 0; \quad \partial Q^* / \partial a = 0 \quad ;$$

$$\partial P' / \partial a = -b(1 + 1/k) / 4a^2 < 0 \quad ; \quad \text{and}$$

$$\partial Q' / \partial a = 0 \quad .$$

The areas under the short- and long-run marginal benefit curves could be used to calculate the costs and benefits of policies in the first two categories and derive the optimal combination of import quotas and inventory accumulation.⁵ But, in this example, no such comparison is needed since the last policies produce the benefits of the first two policies with none of the accompanying costs. In this example the policies in the third option are clearly superior.

⁵W.D. Nordhaus, "Energy in the Economic Report," American Economic Review, 64 (September 1974), 558-565, or D.H. Newlon and T. Tietenberg, "A Model to Evaluate the Cost Effectiveness of Policies to Reduce Import Vulnerability," FEA Discussion Paper OEI-75-11, May 15, 1975.

The policies in the first option can be counterproductive. Many proposals to reduce demand also entail decreasing the sensitivity of the demand to changes in the price. For example, Nordhaus proposed a tariff that decreased as the world price of oil increased.⁶ Figure 3 describes the effect of such a tariff on the demand for energy imports. In order to represent policies in which demand is simultaneously reduced and made less sensitive to future changes in the price, let $a(b)$ where $\frac{\partial a}{\partial b} > 0$. Differentiating equation (3) for b ,

$$\frac{\partial P^*}{\partial b} = \frac{1}{2a} - b/2a^2 \frac{\partial a}{\partial b} .$$

$$\frac{\partial P^*}{\partial b} < 0 \text{ if and only if } \frac{\partial a}{\partial b} > \frac{a}{b} > 0 .$$

For most economies, a is usually small relative to b so $\frac{\partial a}{\partial b} > \frac{a}{b}$ is a likely prospect. If this is the case, reducing demand does not decrease but rather increases price. Consumption falls as the price increases:

$$\partial Q^*/\partial b > 0 .$$

If this policy is counterproductive in the long-run because it drives up price instead of lowering it, then it will also be counterproductive in the short-run. From equation (6)

$$\frac{\partial P'}{\partial b} = \frac{\partial P^*}{\partial b} (1 + 1/k)/2 ,$$

so if $\frac{\partial P^*}{\partial b} < 0$ then $\frac{\partial P'}{\partial b} < 0$ and short-run vulnerability is

⁶Nordhaus, "Energy in the Economic Report," p. 563.

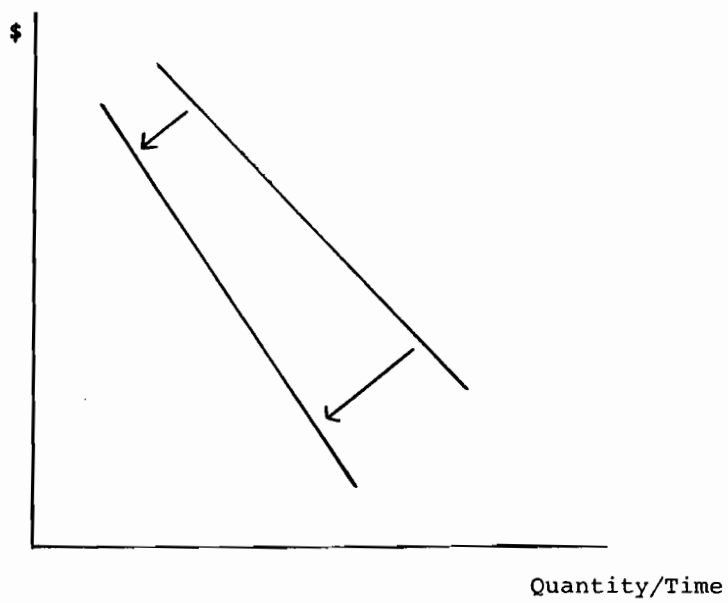

Figure 3. Effect of a tariff inversely related to world price.

increased. Since $\frac{\partial Q'}{\partial b} = \frac{\partial Q^*}{\partial b} \frac{(1+b)}{2} > 0$ in the short-run, consumption falls as the price increases.

In this illustrative example, the set of policies least considered by analysts and policy makers proves most attractive. The policy most likely to be adopted is least attractive and under reasonable assumptions completely counterproductive.

This result does not prove the superiority of policies in the third option or the inferiority of policies in the first option. These results depend on several assumptions that might not hold in the real world. First, approximating the demand for energy imports by a linear function might prove inaccurate. Second, the oil consuming countries might aim to achieve their goal of lower prices by putting enough pressure on the cartel that the member nations start to compete with each other and drive down the world price. In this case, the assumption, that the cartel maximizes revenue after demand is reduced, would be violated. Third, energy is produced from nonrenewable resources. Cartel members might set prices in order to maximize the present value of all future revenue from these resources. Finally, the nature of the emergency might be different from what is assumed in this example. The cartel could retaliate against oil consuming countries for political and social as well as economic reasons. But the illustrative example does demonstrate that there is a category of promising policies for increasing energy independence that has not received adequate consideration.

Discussion

Hoffmann

On the Gorbet paper presented by Erdmann, I find it very important that Gorbet made it possible to test his model to find out how sensible it is to variants of the assumptions made in the model. I find the calculation of the input and output BTU's a bit complicated, for I do not know if in all cases the data are available. For instance, for the FRG, they are not yet available. Perhaps Canada has better information.

Hutber

I would like to discuss our efforts in the UK. The "model" used for energy demand forecasting in the UK is nearest to that used by Canada. It contains the feature that the forecasts are made exclusively in terms of total useful energy, and a complete historic data base for total useful energy by sector is maintained. Final demand and primary inputs are determined after the fuels have been allocated to sectors. I must give a word of warning against econometric models because the price elasticity concept may not be true, since it is based on progress towards an equilibrium balance of fuels, but the reality is that fuels may not be in that sort of situation. Recall that we have had a coal "hump," are presently experiencing an oil and gas "hump," and may later get a nuclear "hump" in fuel supply, the transitions from one "hump" to another being more closely associated with constraints of substitutions rather than price movement.

The UK employs game theory in their solutions to the balance of fuel supply--playing the "states of the world" variations of oil planning price and UK growth rate against possible policy options of supply to form a matrix of solutions which can then be analyzed. Aggregation is also a problem. The UK uses six sectors in all, and we do not think that further

disaggregation is worthwhile, especially with the restricted range of activity indicators available from the macroeconomic models for the medium term. The final point is that I was not too sure in the Waverman paper when he talked about time trends whether this was just a time variable or not. In my remarks I am assuming that it was. Econometricians should not despise time trend analysis as the time variable may be a proxy for consumer behavior. However, time trends should not be used without corrections, for instance for the "trade cycle" in the short term, and saturation and efficiency in use improvements in the longer term.

In using time variables as a proxy for behavioral variables, we put corrections in for the effects of the macroeconomic parameters. So in the short term, we can, for instance, represent the trade cycle in our energy forecast, and in the medium term we can get to new relationships which we think will exist in our economy in five and ten years time. There are other corrections as well as the macroeconomic one and these are saturation effects that one can identify in certain areas. For instance, you can estimate the penetration of central heating in the domestic market and you can make allowances. So there are a whole host of corrections that you can make to what is extensively described as a time trend analysis.

India's Fuel Needs and Options

Kirit S. Parikh

1. Introduction

In March 1971 India's population was 547 million. The GNP in 1970-71 was Rs 666, less than US \$85 per capita¹ at current prices and at factor cost (US \$48 at 1960-61 prices), and the per capita energy consumption was less than 0.8 tonne of coal equivalent per year. Increased availability of energy is necessary if the country is to grow, and economic growth in turn would increase the demand for energy. This interdependence on future demand and availability is of great consequence for India, as the development of the energy sector requires large investment resources which are in short supply. The energy problem for India is not the problem of finiteness of natural resources but the problem of paucity of other resources to develop these resources. In projecting energy needs the emphasis has to be on finding low cost alternatives. An integrated approach to planning and projecting fuel needs is called for.

Nearly half of the total energy consumed in the country is for domestic cooking and lighting. A major problem is to find feasible options to meet the domestic needs of the rural population (which may be between 650 to 800 million by AD 2000) spread over 500,000 villages and to evaluate the relative economics of different choices. Even by the end of the century domestic energy needs for cooking and lighting will still constitute 20% to 30% of the total energy requirements.

India's population at the end of the century will be between 870 million and 1,100 million. Since the scope of expanding the area under cultivation is negligible, massive efforts should

¹ Throughout this paper an exchange rate of Rs 8.00 per US dollar is used.

be put in for intensive cultivation which will require irrigation, chemical fertilizers and pesticides. All these would call for additional supplies of energy. This energy, plus energy for cooking and lighting, will be required all over the country and not just in a few large industrial cities.

With economic development energy needs for industrial use and for transport will increase. In India's planned economy this is best estimated on the basis of the pattern of planned end uses. For a given set of end uses, a programming approach can be useful in identifying the optimum mix of fuels and techniques to meet these needs.

Before we examine India's fuel needs and options in the domestic and industrial sector for the next twenty-five years, we describe the pattern of energy consumption in India as well as India's energy resources.

2. Present Consumption Pattern

2.1 The Broad Pattern

The fuelwise consumption of energy in India from 1953-54 to 1970-71 is given in Tables 1 and 2. The most striking feature in these tables is that the non-commercial energy is a very significant part of total energy consumption. Though declining as a percentage of total energy, consumption of non-commercial energy is increasing. The non-commercial fuels are inferior in the sense that with increasing income people consume less of them. These are used by many villagers and by urban poor because these fuels are available, and available without immediate financial outlay. However, they have in most cases a better economic use elsewhere.

Another thing to note is that the consumption of commercial energy in India on a per capita basis is one of the lowest in the world. The per person consumption of commercial energy

in the US is more than fifty times that of India. In Table 3 the consumption by sector and the sources of commercial energy in India for 1970-71 are given.

The flow of various sources of energy into different sectors for 1970-71 is shown schematically in Figure 1. A schematic flow diagram for major oil products is given in Figure 2. From these data emerge the broad pattern of energy consumption in India, the main characteristics of which are summarized below by fuels.

2.2 Coal

The major users of coal are:

| | <u>Percent of total consumption in 1970-71</u> |
|--------------------------|--|
| 1) Steel plants, | 19 |
| 2) Railways, | 23 |
| 3) Thermal power plants, | 22 |
| 4) Cement industry, | 5 |
| 5) Brick industry, | 4.5 |
| 6) Domestic coke, | 6 |
| 7) Paper industry, | 2 |
| 8) Textile industry, | 2 |

These users consume among themselves nearly 83% of the coal.

2.3 Oil Products

India's consumption constitutes less than 1% of the world's oil production, and two-thirds of the oil consumed in India is imported. With the increased price of oil even this very small import puts an enormous burden on India's foreign exchange resources. It is of utmost importance to reduce consumption of oil and oil products.

Nearly 80% of the use of oil products is for energy purposes. The middle distillates (kerosene, aviation turbine fuel (ATF), high speed diesel oil (HSDO) and light

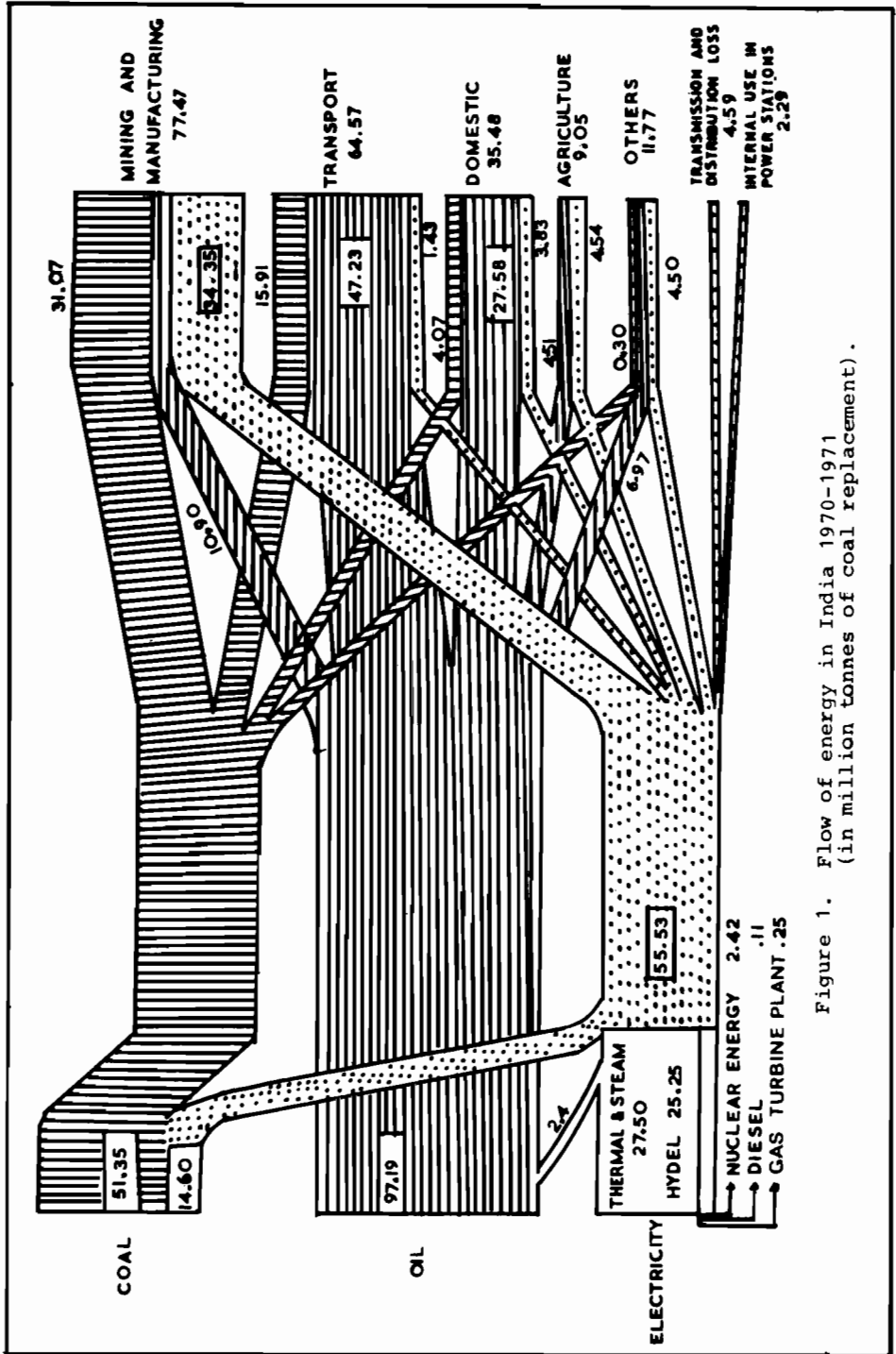
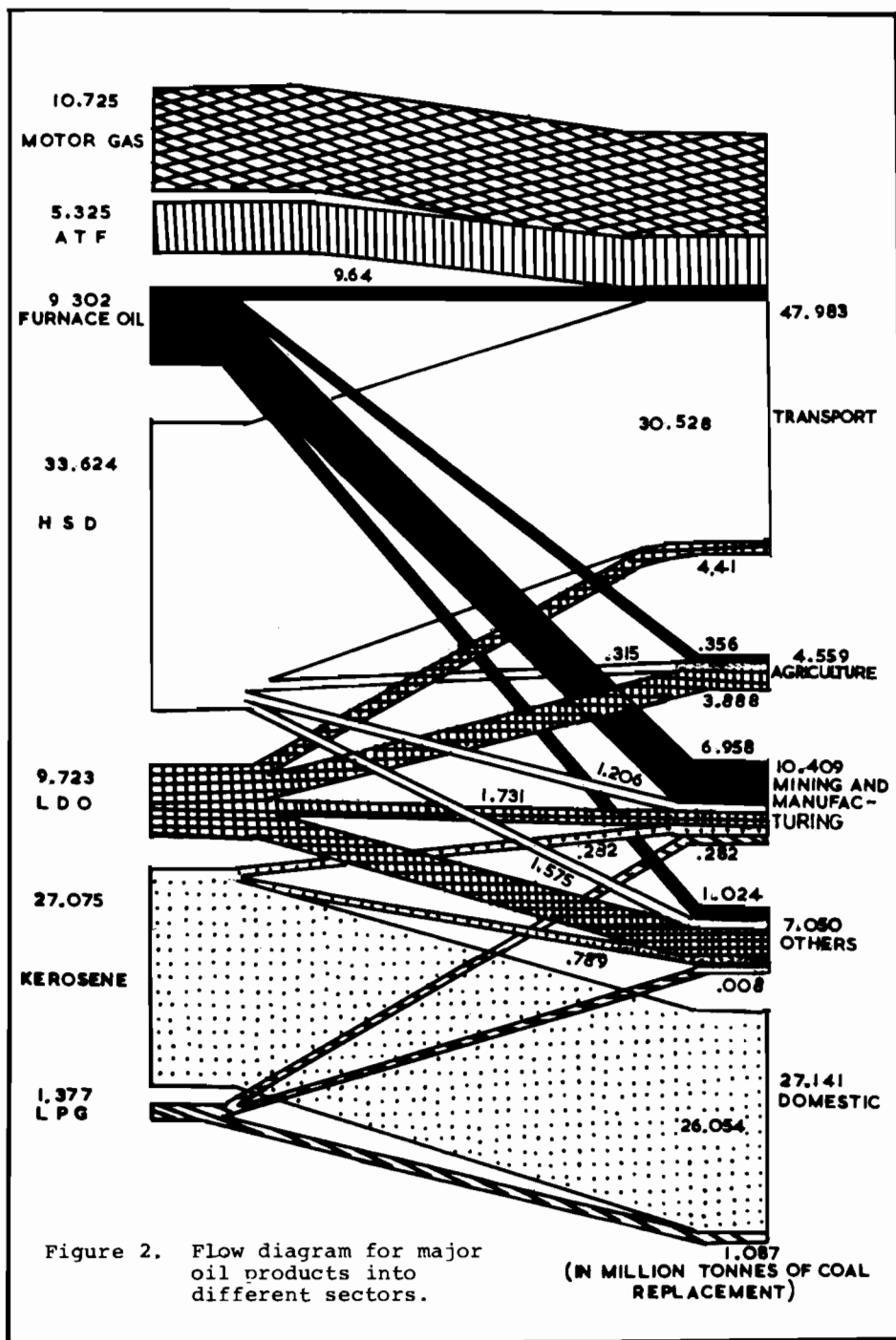

Figure 1. Flow of energy in India 1970-1971 (in million tonnes of coal replacement).



diesel oil (LDO) constitute 50% of total oil use. Kerosene which is used as a fuel in the domestic sector accounts for more than 10% of the oil demand in India. HSDO, used for railways, trucks and buses, accounts for almost 40% of the total oil use. Motor gas (petrol) used for automobiles, scooters and three wheelers is 7% of the total oil demand.

2.4 Electricity

More than 75% of electrical energy is consumed in the manufacturing sector, and forty-seven major industries consume 70% of electricity used in industry. The consumption in other sectors will go up with the progress of rural electrification, electrification of railways and development of mass transport to reduce consumption of oil products.

Of the 55.8 bkwh (billion kwh) of electrical energy generated in 1970-71, 47.7% came from coal, 45.0% from hydro and 4.3% from nuclear plants. The remaining 3.0% came from oil fired plants. The progress of rural electrification can be seen from Table 4 whereas the electrical energy consumption by pumpsets is given in Table 5.

2.5 Domestic Sector

The requirement of energy for cooking and lighting is a substantial portion of energy needs in the country today. This is expected to remain so in 2000-01. Though energy consumption in other sectors is increasing at a rapid rate, the increase in population will also increase need for energy for domestic consumption.

The eighteenth round survey of the National Sample Survey conducted between February 1963 and January 1964 covered 4,000 urban households and 21,000 rural households. It provided for the first time estimates of consumption in rural households by different expenditure classes.

In rural areas, the use of firewood does not depend much on the expenditure level. Also dung cakes are used by all expenditure classes and in fact the use of dung cakes increases with the expenditure level. Use of kerosene is more or less constant for the three lowest expenditure classes up to monthly household expenditure of Rs 150.00 and a significant increase is found only in the highest expenditure classes of monthly household expenditure of Rs 300.00 and above.

In urban areas the consumption of commercial fuels (coke, coal, electricity, gas and kerosene) is higher. In addition, firewood consumption decreases with increasing expenditure level. Surveys were also carried out by the NCAER on the energy consumption in Bombay, Calcutta, Delhi and rural India. Based on these, the domestic energy consumption has been estimated. This is shown in Table 6.

The NSS estimates of domestic consumption, given in Table 7 are lower than the NCAER estimates. Moreover, the rural estimates of energy consumption are higher than the urban estimates. The rural population uses fuels from the non-commercial sector, and they are gathered free of private costs. They may, thus, waste more fuel compared to urban consumers. This result may also be due to the fact that the conversion rates used are erroneous, particularly in the case of non-commercial fuels. For example if burning firewood is 20% less efficient than implied by the 0.95 coal replacement factor, the estimates for rural energy consumption will become lower than the estimated urban consumption.

There is thus considerable uncertainty about the need for domestic energy in India. However, one may take as an upper bound the estimated consumption of 0.44 tonne of coal equivalent per annum per person, as was found in the latest systematic survey of energy consumption in Bombay by NCAER.

3. Energy Resources of India

Of the conventional sources of energy, India is well endowed with coal, has sizeable hydroelectric potential, and has one of the largest deposits of thorium in the world. However, the available oil and gas reserves are very meagre. In addition, non-commercial fuels such as firewood, animal dung and agricultural wastes are available in sizeable amounts.

3.1 Coal

The reserves of non-coking coal are more than eighty billion tonnes, are adequate to last for at least 100 to 150 years and may last much longer than that. However, the coal has a high ash content and is geographically concentrated. The coking coal reserves are around twenty billion tonnes and are enough to meet the metallurgical needs for the next forty years.

3.2 Oil and Gas

In 1971 the proved reserves of crude oil and natural gas were 127.84 million tonnes and 62.48 billion cubic metres respectively. However, only about 4% of the potential oil bearing sedimentary area in the country has been explored so far.

3.3 Hydroelectric Resources

After evaluating 260 specific schemes the central water and power commission estimated the total hydro power potential to be 41,155 MW at a 60% load factor. The estimates of power based on a 60% load factor seriously understate the potential. Zonal grids are being established and the hydro plants in the future will be operated in the system for peaking purposes. The power economy committee has estimated that it should be possible to install 80,000 to 100,000 MW of hydro capacity.

3.4 Nuclear Fuels

The reasonably well assured uranium resources of India are about 22,000 tonnes of U_3O_8 , with additional inferred reserves of 24,000 tonnes of U_3O_8 . With a required fuel inventory of four kg. of uranium per KW installed for CANDU type plants, the reserves are adequate to sustain 10,000 MW of installed capacity of first generation plants.

However, these first generation plants produce plutonium and the partially-used, depleted uranium that comes out of such plants can be used in the fast breeder reactors to produce power. The fast breeder reactors are under development and are expected to be available commercially by 1985-90. With its uranium resources, India would be able to support 600,000 to 1,000,000 MW_e installed nuclear capacity for a lifetime of thirty years with an output of 120×10^{12} to 200×10^{12} Kwh.

The fast breeder reactor can also use thorium instead of depleted uranium. India's thorium reserves are estimated to be 450,000 tonnes of ThO_2 . With this the total energy potential of nuclear power becomes $2,400 \times 10^{12}$ Kwh.

3.5 Solar Energy

Large amounts of solar radiation fall in India, and for most of the country very few days are without any sun. The annual average intensity of solar radiation in India is 600 calories per square centimetre per day. Even the minimum available radiation in the month of December is quite large, and for most of the country it is above 500 calories/cm²/day. Thus solar energy is an attractive source of energy for India.

3.6 Non-Commercial Fuels

For the bulk of rural India, domestic energy is obtained from firewood, animal dung and agricultural wastes. This dependence is likely to continue for some time and thus a careful look at these resources is in order.

3.6.1 Firewood

The national forest policy resolution has recommended that one-third of the total geographical area of the country be under forests. At present forests cover seventy-five million hectares which amount to only 22% of the area of the country.

Though the area under forests appears to have remained more or less constant, the data on qualitative aspects of forests is not available. When a forest classified in official records as "Moist Mixed Deciduous with the canopy at 20 metres" is destroyed all that may happen is its classification in official records as "Moist Thorn Scrub with the canopy at 1 metre," and it will still be counted as an area under forest. That considerable qualitative destruction of forests must have taken place is strongly indicated by the data on fuel wood consumption and production.

Though the consumption of firewood was estimated to be 120.25 million tonnes in 1969-70, the recorded output of fuel wood from forests was only 12.88 million cubic metres or about nine million tonnes. The remaining firewood must have come from unrecorded fellings and removal from "treelands" outside forest areas. With the past and present programmes of forestation, it is expected that the availability of fuel wood would increase by 0.5 million tonnes a year till 1985.

3.6.2 Animal Dung

According to the 1966 cattle census the cattle population in India is about 230 million animals. With an average outturn of two kg dry dung per animal per day (ten kg of wet dung), the annual yield can be estimated to be 170 million tonnes of dry dung. With a collection rate of 75%, the dung collected would be 127.5 million tonnes. Since dung can also be used as a fertilizer, not all is available as fuel. However, if this dung is put through a bio-gas plant (Gobar-gas plant) all of it can be used. The energy available will be around 100 million tonnes of coal equivalent.

3.6.3 Agricultural Wastes

The availability of agricultural wastes would depend upon the agricultural production, and can be assumed to grow at the same rate as the output of agriculture. However, many wastes are currently burned that have better alternative uses. The availability of burning can be assumed to remain at its current value of about forty-four mtce as diversion to more economic uses progresses.

4. Energy for Domestic and Agricultural Uses

4.1 Demographic and Economic Assumptions

If one were to assume that the success of family planning in India would be no better in future than what has been attained so far and project the population on that basis, one would get a conservative estimate of India's population. Similarly, compared to the growth rate of national income of 3.5% per annum that has been realized over the past twenty-five years, an assumed growth rate of national income of 5.5% per annum should give us an optimistic projection for national income. Taken together, these projections provide us with upper bounds of need for the domestic consumption of energy and food and consequently for agricultural energy. The demographic and economic characteristics of this projection are shown in Table 8.

4.2 Energy for Domestic Needs

Using the norms of 0.40 and 0.38 tonnes of coal equivalent per annum per person for rural and urban areas respectively, the total domestic requirement of energy per annum would be 428 million tonnes of coal equivalent (mtce) as follows:

| | | |
|-------|-------------------|-----------|
| Urban | 310×0.40 | = 124 mtr |
| Rural | 800×0.38 | = 304 mtr |
| Total | | = 428 mtr |

To meet this need a number of strategies are possible. We examine below alternative strategies, based on currently available technologies.

4.3 Reliance on Conventional Fuels

Supply of the conventional fuels coal, electricity, kerosene and LPG is being stepped up. Electricity is the preferred source for lighting followed by kerosene. For cooking, in terms of convenience, LPG is most preferred, followed by kerosene and then by coal. Though rural electrification is considered desirable in itself, electricity is not considered as an option for cooking energy as it is inefficient in that use. The domestic needs which are not met with these commercial fuels have to be met through the use of conventional non-commercial fuels.

a) The spread of electrification is taken to be such that 80% of the rural households and 100% of the urban households will have electric lights by 2000-01. With a norm of 200 kwh per year per household (average size five members) the requirement of electricity will be

$$\frac{310 + 0.8 \times 800}{5} \cdot \frac{200}{1000} = \frac{38 \text{ bkwh/year}}{38 \text{ mtce/year}}$$

b) The need for lighting for the remaining rural population will have to be met with kerosene. On the basis of five kg of kerosene per person per year this amounts to

$$0.2 \times 800 \times .005 = 0.8 \text{ million tonnes of kerosene} \\ = 6.64 \text{ mtce}$$

Kerosene is a relatively preferred fuel for cooking purposes perhaps second only to LPG. On the basis of the projected economic growth, 25% of the rural population and 60% of the urban population might want it at twenty kg per person per year. Thus the requirement of kerosene for cooking heat works out as follows:

possibly unconventional approach would be required to meet the domestic energy needs. We will now examine some of the options available today, in particular firewood plantations, and bio-gas plants.

4.4 Fuel Wood Plantations: One Option

Data to estimate the fuel productivity of different trees for different regions are not available, and it is not possible to work out an optimal scheme for growing fuel wood. However, some estimates of land requirement are available. Pal² has estimated that for a typical village of 550 people, fifty acres of land devoted to growing firewood should meet the needs for domestic energy.

We may estimate the fuel wood production on the basis of efficiency of photosynthesis in utilizing solar energy. Table 9 presents this efficiency for different crops.

On a conventional tree plantation, without the water and nutrients and care devoted to crops, one may expect smaller yields. If we were to take the utilization to be 0.25%, we can get roughly five tonnes of wood per acre per year ($3 \times 0.25 \times 365$) \div (0.44×120).

Thus fifty acres devoted to forest should produce 250 tonnes of wood per year giving energy equal to 235 tonnes of coal equivalent. This is little more than 210 tonnes of coal equivalent (tce) required for a village of 550 people. Thus Pal's estimate seems to be reasonable.

If twenty-four million hectares of land are used for fuel wood production, 300 million tonnes of wood per year can be obtained. This is enough by itself to meet the domestic cooking needs of the rural population of 800 million, and additionally only

²B.P. Pal, "Land Transformation--A Consideration for the Scientific Basis for Land Transformation Applied to a Particular Village" (ICAR, 1955).

electricity and kerosene would be required for lighting. However, twenty-four million hectares is a lot of land; and this land for fuel wood plantations has to be found within reasonable distances of the villages. With the doubled population in 2000-01, land may be difficult to find in many parts of the country. Nonetheless, whatever land is available for fuel wood plantation, it should be used for that purpose.

In areas where water is available solar energy utilization can be substantially increased as is the case with sugarcane. In fact it may be possible to grow algae or waterweeds such as hyacinths to obtain yields of fifty to eighty-five tonnes of dry matter per acre per year which are ten to seventeen times as much³ as we have assumed above. Thus the required land would be less than three to five acres and may well be available in most villages. Yet the required water may not be easily available, and even when available, may be more available in other agricultural uses. Thus detailed case by case studies are required to estimate the possibilities and economics of growing waterweeds for fuel.

Nonetheless the above does indicate the possibility of finding species of trees which give a much higher yield of fuel wood per acre than the conventional fuel woods for the dry and arid areas. A systematic search is called for.

4.5 Bio-Gas Plants: Another Option

Considerable potential exists for using these plants, which are essentially closed wells or boxes, to ferment anaerobically biological and cellulosic matter with an arrangement to collect the generated gas. This gas is largely methane and constitutes a convenient and clean fuel. The digested sludge with 1.5% to 2.2% N is a better fertilizer (richer in nitrogen)

³Prasad, Prasad and Reddy, "Biogas Plants: Prospects, Problems and Tasks," Economic and Political Weekly, Special Number (August, 1974).

than can be obtained through composting (0.75% to 1% N). Thus when animal dung fertilizes this plant, instead of being dried and burnt as cakes, not only is a cleaner and more convenient fuel obtained, but a fertilizer richer in N is also obtained. Thus one can have one's (cowdung) cake and (h)eat it too. Since methane is a clean burning fuel and the energy in the dung is only recently derived energy from sun (unlike coal or oil in which solar energy was captured eons ago) the plant is also an ecologist's dream come true.

Plants of various capacities can easily be fabricated. The smallest plant has a capacity to hold two cubic metres (sixty ft³) of gas. This is enough to meet the energy needs for cooking and lighting for a family of five to six persons. Dung is to be fed daily in the plant after mixing it with equal quantity of water. This plant needs forty-five kg of wet dung (nine kg of dry dung) per day. The cost for a two cubic metre plant would be about Rs 2,000 including piping and stores. Private and social profitability of this plant is easily established.⁴ We will assume that in the absence of the plant the dung collected is either burnt or used for composting. We also assume that the dung collected is 75% of the total dung output.

We have compared three alternatives for a family of five persons to meet its needs for fuel and fertilizer. The first alternative is to install a bio-gas plant. Besides providing a convenient and clean form of energy, this also gives organic fertilizer whose nitrogen content alone is worth Rs 214. Alternatively the family may burn all the dung. This would not be enough to meet its fuel needs and it would have to be supplemented by kerosene for lighting and dung for cooking. In addition fertilizer will have to be purchased. In the third

⁴Kirit S. Parikh, "Benefit-Cost Analysis of Bio-Gas Plants in India," S.M. Thesis, Department of Economics, M.I.T., 1963.

alternative, kerosene for lighting and all the dung for fuel are purchased and the dung from owned cattle is used for composting. Though fuel purchased is assumed to be dung cakes, it need not be so. Dung cakes are considered only to get a lower boundary on the cost of fuel.

Installation of bio-gas plants earns a gross return of 14% to 18% purely in financial terms. This is without taking into account all the benefits of a clean, convenient fuel, or the humus in the organic fertilizer produced.

4.6 Scope of Bio-Gas Plants in Meeting Rural Energy Needs

From a social cost-benefit point of view the bio-gas plants are even more attractive, particularly as both fertilizers and kerosene have high import content and as the country is short of fertilizers and food.

It is estimated that about twelve million households in the country have enough animals to operate their own plants. Since most of these households may be comparatively richer and larger, their current fuel consumption pattern is taken to be as per the expenditure class of Rs 150-300 for thirty days per household. With this the fuels saved by installing twelve million family-sized (7.5 persons per family) plants of 100 ft³ each have been estimated. These are shown in Table 10.

At Rs 2500 per a 100 ft³ plant, twelve million plants will cost Rs 3.00 crores.⁵ The resulting savings of fuels amount to .43 million tonnes of coal and coke, twenty-four million tonnes of firewood, 10.3 million tonnes of dung and 0.43 million tonnes of kerosene. Except for dung which will feed the plants these fuels would be available to others. These plants will also produce 7.4 million tonnes of organic ferti-

⁵A crore is a value unit equal to ten million rupees; Rs 3.00 crores = Rs 30,000,000.

lizers having 0.148 million tonnes of nitrogen, from dung that would have been burnt. In addition fifty-two million tonnes of dung would be fed into these plants instead of in compost pits, and would produce 0.728 million tonnes of additional nitrogen to what would have been obtained from composting. Thus additional nitrogen produced is 0.876 million tonnes. When valued for nitrogen content only this amounts to $4500 \times .87 \times 10^6 = \text{Rs } 4.00 \text{ crores}$, without any foreign exchange requirement. It should be noted that our estimates of nitrogen obtained from these plants have been extremely conservative. When we add to these the values of fuel and improvement in sanitation these plants look even more attractive.

4.7 Community Sized Bio-Gas Plants

The number of animals required per household is a serious limitation in the use of bio-gas plants. Nearly 78% of the households with bovine animals do not have enough animals to install a bio-gas plant. A community sized plant can be installed to pool the dung from many households. However, a number of institutional problems have to be solved before a community plant can work satisfactorily.

The problems of purchase and valuation of dung, and of distribution of gas and fertilizers are serious. Nonetheless community sized plants are economically very attractive and can play a significant role in meeting rural energy needs. In cold winter months the gas production is only half the gas generation in the summer. A small, family sized plant is designed to be adequate to meet the needs of the family in the low production winter months and the extra generation of gas in the summer goes waste. A community plant not only makes it possible to use this gas but also makes it possible to process the dung from all the animals in the community.

A plant of 5,000 ft³/day capacity, supported by 275 bovine animals, can meet 75% of the energy needs of a community of 550 people (100 families).

If the cattle population in year 2000-01 is assumed to remain more or less at its current level of 200 million equivalent adult bovine heads in rural India, they should certainly be well fed. As the output of food would have to be more than double its present level the roughages produced should show corresponding increases. Thus the availability of dung can be taken to be twice the availability of dung today. The 200 million well fed bovine animals should support 1.45 million ($200 \times 2 \div 275$) community sized plants. Thus with 1.45 million such plants we can meet three-fourths the domestic energy needs of the 800 million rural population in 2000-01. These plants would provide energy equivalent to 228 mtce and only seventy-six mtce of energy have to be found from substitute fuels such as coal, firewood or agricultural wastes, and kerosene demand can be almost completely eliminated from rural India. The resulting domestic energy scene is summarized in Table 11.

In addition each of these plants will produce fertilizer with 3.47 tonnes of nitrogen per year. The 1.45 million plants will thus produce five million tonnes of nitrogen/year. The total investment required will be $\text{Rs } 80,000 \times 1.45 \times 10^6 = \text{Rs } 1.16 \text{ crores}$. We now summarize in Table 12 the fuel balances implied by these alternatives.

These alternatives are all technically feasible. However, a detailed analysis of the opportunity costs of land required to evaluate the relative economic attractiveness has not yet been carried out.

5. Planning and Projecting Fuel Use: An Integrated Approach

A major objective of a National Fuel Policy would be to meet the energy and feedstock needs of different activities at minimal costs. The costs should include the cost of fuels, products, transport of fuels, and other raw materials and products. Thus locations of power plants, the feedstock to be

used in fertilizer plants and plant locations, locations of refineries and their product patterns and modes of transport all become inter-related decisions. It would be easy to write a grand programming model to simultaneously determine these choices. However, to compute such a model may be very difficult. It would be worthwhile to break up the problem into a set of computable models. We describe below a set of such models which are relevant for India.

5.1 Determination of End Use Levels

We assume that a perspective plan for the economic development of the country is already made.⁶ The expected population, gross national product, patterns of income distribution and consumption would be prescribed in this plan. This would then help determine the levels of domestic production of different industries especially those using energy. In particular, it would also prescribe the need for agricultural productions.

5.2 Irrigation and Fertilizer for Food Production

Given the required food production one can determine the requirements of fertilizers and irrigation as follows: The country is divided into a number of homogeneous agroclimatic zones on the basis of soil type and climatological characteristics. Assuming a programme of development of irrigation, these zones are further subdivided into irrigated and unirrigated subzones. Based on agricultural experiments, production functions for different varieties of various crops are estimated to give yield (output per unit area) as functions of amounts of fertilizers applied for each subzone.

⁶For models of long term planning, see R.S. Eckaus and K.S. Parikh, "Planning For Growth: Multisectoral, Intertemporal Models Applied to India" (MIT press, 1968).

A programming model is then run to determine the minimum amount of fertilizers required to produce the prescribed output.⁷ Next the assumed development of irrigation is modified and a new solution obtained. This way the trade-offs between irrigation and fertilizers are worked out, and a combination can be selected as a preferred solution. This would give the amounts of fertilizers and irrigation development required in different parts of the country.

5.3 Surface Irrigation and Ground Water Pumping

In India hydroelectric power is found to be cheaper than other types of power. Many good sites still remain to be developed, and for the next two to three decades hydropower is expected to remain the cheapest power. Moreover, development of hydropower usually provides other benefits of irrigation and flood control. Thus the development of hydropower should get a high priority. However, the pace of development is constrained by our ability to prepare schemes, to execute projects and to settle international water disputes.

The programme of development of hydro-schemes is taken to be prescribed from these considerations. This would also determine the availability of surface irrigation. The remaining irrigation has to be provided from ground water, and a programme of ground water development is drawn up. This determines the need for energy for pumping.

⁷For applications of such a model, see K.S. Parikh and T.N. Srinivasan et al., "Optimum Requirement of Fertilizers in the Fifth Plan Period" (Indian Statistical Institute and Fertilizer Association of India, 1975). Also see, K.S. Parikh "India in 2001," paper presented to IEA conference at Velascore, France, September 1973.

5.4 Projecting Requirements for Electricity

The plans for rural electrification, which is considered a desirable thing in itself, are made within the constraints of available resources as a part of the prospective plan. This determines the demand for electricity in rural areas for domestic use. It also helps determining the number of tube wells which will be electrified and the number which will operate on diesel pumps. From the output targets of the major electricity consuming industries industrial demand for electricity can be projected based on input norms.

5.5 Share of Hydro, Nuclear and Coal Generation

As the pace of hydro development is considered to be fixed, the choice of generation is between nuclear or coal based plants. Since India is poorly endowed with oil, electricity generation based on oil is not a real option.

With India's limited uranium availability, which can support about 10,000 MW for thirty years, nuclear power is an option mainly to the extent that fast breeder reactors can be developed and used. This is particularly so as India has vast thorium reserves, and the accumulation rate of a plutonium inventory becomes important. To determine the growth of nuclear power a multi-period, multi-region programming model is constructed. The objective is to minimize the present discounted cost of meeting the demand for electricity in the different regions by nuclear or coal based plants. Whereas the coal cost varies from region to region, nuclear cost is independent of site. The availability of hydro plants is prescribed from outside the model. However, hydro availability fluctuates from year to year depending on how good the monsoon is. To prescribe hydro availability in such a manner as not to affect the choice of other plants, credit is taken only for the minimum capacity that is available over the years while at the same time credit is taken from the average energy that is available over the years.

The fuel cycle details of nuclear reactors are built into the model, the outcome of which is the nuclear capacity to be installed in different regions in different years by the type of nuclear plant. It also gives similar details for the coal based plants.

5.6 Demand for Coal, Location of Coal Based Plants

Eight major users of coal consume more than 80% of the coal. The needs for the steel, cement, brick, paper and textile industries can be determined using norms and production targets. The requirements for domestic use were discussed earlier. The remaining sectors are railways and thermal power plants. The demand for coal-based plants is determined in the model described above. However, the locations and the unit size of plants and the associated transmission network should be examined with some detail. Whether to have a plant at the pit head or to have a plant at the load centre, is determined next. For this purpose a mixed integer programming model is constructed to determine simultaneously the locations and unit sizes of plants as well as the transmission lines and capacities in the grid. The objective is to meet the demand at the various demand points with a minimum total system cost. The model can be solved heuristically.⁸

Such studies have to be carried out for all the five regional grids in the country. This will give the requirement of coal in different parts of the country.

⁸K.S. Parikh and S.S. Shiralkar, "Report on Electrical System Study for Northern Electricity Region for 1978-1979" (Programme Analysis Group, Department of Atomic Energy, Bombay, January, 1972).

5.7 Energy for Railways: Coal, Diesel or Electricity

For routes with low traffic density, coal based traction is cheapest. With diesel traction the traffic carrying capacity of the track is substantially increased. Electrification increases the track capacity even further. Whereas a switchover from steam to diesel traction is attained merely by changing the engine from steam to a diesel one, the changeover to electric traction needs substantial investment in signalling and track electrification.

The choice of type of traction would depend largely on the traffic density on the route. The traffic density in turn depends upon the policy on road versus rail transport. In terms of fuel efficiency railways need per tonne-kilometre almost one-tenth the diesel fuel required by road transport. Thus to save oil, as much goods traffic as possible should be carried by railways. Certainly, all long distance traffic should be carried by railways which should both improve the speed and reliability of movement, and introduce containerized and piggyback services. A separate study has to be carried out to determine the density of traffic on various routes, and consequently the type of traction required.

5.8 Demand for Oil Products

Many industries which burn furnace oil can also burn coal. This may require additional investment in modifying the boilers. Yet with the prevailing relative prices of oil and coal, this investment may be worthwhile.

The choice between public mass transport or private transport will determine demand for motor gasoline and diesel fuel. Though in the coming twenty-five years consumption of motor gasoline may not be much, the choice is worth making now. In terms of fuel efficiency per passenger kilometre, public buses use only one-twentieth the fuel used by private automobiles.

Diesel fuel demand for pumping water has been determined above, and demand for tractors would depend on government policy on mechanization. The demand for kerosene for domestic use was examined earlier.

The requirements of naphtha as a feedstock in chemical industries can be calculated using norms and projected outputs. However, requirements for feedstocks in fertilizer manufacture are determined in the model described next.

5.9 Refinery Capacity, Product Mix, Trade in Oil Products and Fertilizer Feedstocks

A single period programming model is constructed to determine the location, capacity and feedstocks for fertilizer plants and also the location, capacity and processes of refineries.⁹ Trade is permitted in oil products. Transportation of oil and/or products is also permitted through various modes. The objective is to meet the demands of various oil products and fertilizers at minimum cost, including the cost of transport. As feedstocks for fertilizers we list naphtha, fuel oil, coal and electrolysis.

5.10 Planning Coal Supply

With the determination of feedstocks, needs for coal in different regions become known. Knowing the reserves and costs of coal production at different coal fields a programming model is constructed to meet this need at the minimum delivered cost. In order to get consistent results it may be necessary to carry out this set of studies iteratively. This integrated approach to planning and

⁹For application see R.K. Bhatia, "A Spatial Programming Model for India's Petroleum and Petrochemical Industries" (Diss. Delhi School of Economics 1975).

projecting needs for fuel described briefly above should give better results than when plans and projections are separately made.

6. India's Fuel Needs in 2000-01

Projections for the fuel needs of India for the year 2000-01 are now made¹⁰ within the broad framework of the approach described above. A set of demographic and economic projections can be made which would highlight the problems of meeting industrial fuel needs.

Here we make an optimistic assumption that population and urbanisation would be controlled and that economic growth would be faster than what has been assumed in the projections for studying domestic energy needs. The population in 2001 is projected to be 870 million of which 210 million would be urban population. The national income in 1960-61 prices will be Rs 114,000 crores (US \$142.5 billion), which amounts to a per capita income of Rs 1,310 (US \$164).

Two sets of requirement estimates are made. The first set, case A, assumes that the oil price will stabilize at US \$5 per barrel by 1978-79. The OPEC cartel is supposed to break up, and fuel substitution justified by such an oil price is supposed to take place. The second set, Case B, is based on the assumption that relative fuel prices will remain at the level of early 1974, and substitution of other fuels for oil products in areas where techno-economic feasibility exist, will be pushed. Some of the major possibilities are the following:

- 1) accelerated electrification of railways to reduce demand for diesel;
- 2) faster rural electrification for reducing demand for kerosene and diesel;

¹⁰For details, see K.S. Parikh, "India in 2001--Fuels" (Indian Statistical Institute, February, 1975).

- 3) coal based fertilizer plants in place of naphtha or fuel oil based plants;
- 4) provision of soft coke for domestic use to save kerosene;
- 5) coal instead of fuel oil for industrial energy; and
- 6) conversion of oil based power plants to coal based plants.

6.1 Overall Requirements of Fuels

The summary of these estimates are presented in Table 13. In case A, the requirements for coal are expected to go up from sixty-six million tonnes in 1970-71 to 600 mt in 2000-01. The requirements for oil products are to grow from eighteen million tonnes in 1970-71 to 147 mt in 2000-01. The demand for electricity is expected to grow to 670 billion kwh.

The requirements of coal, oil and electricity in case B for 2000-01 are 650 mt, 97 mt and 700 billion kwh respectively. Compared to 1970-71, these are ten times, five times and thirteen times as large. The detailed estimates for different fuels are described below.

6.2 Requirements for Coal

The estimates of sector-wise requirements of coal are shown in Table 14.

6.3 Requirements for Electricity

The estimates of usewise requirements for electricity are shown in Table 15.

6.4 Requirements for Oil

The estimates of requirements for oil products are shown in Table 16.

7. Scope for Substitution of Oil Products

Between case A and B, fifty mt of coal and thirty billion kwh of electricity substitute fifty mt of oil products. It is interesting to examine the details of these substitutions which are summarized in Table 17.

Thus, 49.1 mt of oil products in these selected areas is replaced with twenty-three bkwh of electricity and 38.1 mt of coal. To this should be added seven bkwh of auxiliary consumption and transmission losses to supply these twenty-three bkwh of electricity. This thirty bkwh of electricity is generated using eighteen mt of coal. Thus in effect 49.1 mt of oil products are replaced by producing 49.1 mt of coal net of the collieries' own consumption.

What is clear here is that the biggest opportunity in substituting oil products is in the transport sector. Making rail transport attractive for goods and passenger traffic is vital for substitution. Rail transport is also important for the movement of coal itself.

The production of coal has to be expanded to ten times its 1970-71 level. Action has to be taken now for detailed explorations to prepare a set of project reports so that this expansion in output becomes feasible and without avoidable costs. The analysis also shows the economic attractiveness of secondary refining for India. This also calls for advance action in planning refinery capacity.

8. Concluding Observations

a) For a large part of India's population, the costs of fuel for cooking and lighting would exceed the ability to pay for the fuels if they were to be commercial fuels. This inability makes the population rely on non-commercial fuels such as illegally-collected fuel wood and dung. The consequent ecological damage can be prevented by a planned effort at reforestation or by a large scale adoption of

bio-gas plants. The economists' concept of demand is relevant for this population only in terms of choice of fuel and not in terms of absolute level of energy consumption since it must cook.

b) An integrated approach to planning and projecting fuel needs can be cost effective and can help in identifying in time policy options which may have long gestation periods.

Table 1. Consumption of energy (1953-54 to 1970-71)
(in natural units).

| Year | Commercial Energy ¹⁾ | | | Non-commercial Energy ²⁾ | | |
|---------|---------------------------------|-----------------------------|---------------------------------------|-------------------------------------|-------------------------------|---|
| | coal in million tonnes | oil in million tonnes | electric- ity in billion kwh | dung million tonnes | firewood million tonnes | vegetable waste million tonnes |
| (1) | (2) | (3) | (4) | (5) | (6) | (7) |
| 1953-54 | 28.7 | 3.39 | 7.6 | 46.4 | 86.3 | 26.4 |
| 1954-55 | 28.5 | 3.61 | 8.4 | 47.6 | 87.5 | 27.0 |
| 1955-56 | 28.8 | 3.99 | 8.4 | 48.8 | 88.8 | 27.7 |
| 1956-57 | 30.7 | 4.31 | 10.2 | 50.1 | 90.1 | 28.4 |
| 1957-58 | 34.6 | 4.65 | 11.8 | 51.4 | 91.4 | 29.1 |
| 1958-59 | 36.1 | 4.98 | 13.2 | 52.7 | 92.7 | 29.9 |
| 1959-60 | 35.7 | 5.49 | 15.44 | 53.3 | 96.3 | 30.2 |
| 1960-61 | 40.4 | 6.02 | 16.9 | 55.38 | 101.04 | 31.08 |
| 1961-62 | 40.2 | 6.68 | 19.37 | 56.10 | 102.39 | 31.51 |
| 1962-63 | 49.1 | 7.64 | 22.57 | 56.75 | 103.58 | 31.87 |
| 1963-64 | 48.6 | 8.07 | 25.21 | 58.57 | 106.88 | 32.89 |
| 1964-65 | 48.2 | 8.87 | 27.76 | 59.30 | 108.19 | 33.28 |
| 1965-66 | 51.8 | 8.41 | 30.56 | 61.28 | 111.82 | 34.41 |
| 1966-67 | 52.3 | 10.00 | 33.26 | 62.60 | 114.21 | 35.14 |
| 1967-68 | 54.5 | 10.41 | 36.76 | 64.07 | 116.92 | 35.97 |
| 1968-69 | 53.0 | 11.59 | 41.46 | 64.98 | 118.54 | 36.46 |
| 1969-70 | 56.66 | 13.97 | 45.02 | 65.92 | 120.25 | 37.00 |
| 1970-71 | 51.35 | 15.31 | 48.65 | 67.28 | 122.76 | 37.77 |

- Notes: 1. Coal consumption figures exclude coal used for power generation.
 2. Oil consumption figures exclude oil used in power generation and refinery boiler fuel.
 3. Oil consumption figures in this table follow the calculation made by the Energy Unit of the Planning Commission.
 4. Dung weight on dry basis.

¹⁾ Source for commercial energy figures is the Fuel Policy Committee report, draft (March, 1974).

²⁾ Sources for non-commercial energy are 1953-54 to 1959-60 Energy Survey Committee Report (1964); 1960-61 to 1970-71 Fuel Policy Committee Report, May 1974.

Table 2. Consumption of energy (1953-54 to 1970-71)
(in million tonnes of coal equivalent).

| Year | Commercial Energy | | | | Non-commercial energy | | | | Grand total |
|---------|-------------------|-------|-----------------------|--------|-----------------------|-------|-------------------------|--------|-------------|
| | Coal | Oil | Elec- tric- ity | Total | Fire- wood | Dung | Vege- table waste | Total | |
| (1) | (2) | (3) | (4) | (5) | (6) | (7) | (8) | (9) | (10) |
| 1953-54 | 28.7 | 23.8 | 7.6 | 60.1 | 82.2 | 18.6 | 25.1 | 125.9 | 184.5 |
| 1954-55 | 28.5 | 25.8 | 8.4 | 62.7 | 83.3 | 19.1 | 25.6 | 128.0 | 188.4 |
| 1955-56 | 28.8 | 30.3 | 9.4 | 68.4 | 84.4 | 19.6 | 26.3 | 130.3 | 194.4 |
| 1956-57 | 30.7 | 31.2 | 10.2 | 72.1 | 85.6 | 20.1 | 27.0 | 132.7 | 201.6 |
| 1957-58 | 34.6 | 33.9 | 11.8 | 80.3 | 86.9 | 20.6 | 27.7 | 135.2 | 211.6 |
| 1958-59 | 36.1 | 36.1 | 13.2 | 85.4 | 88.3 | 21.1 | 28.4 | 137.8 | 219.1 |
| 1959-60 | 35.7 | 40.1 | 15.4 | 31.2 | 91.7 | 21.3 | 28.7 | 141.7 | 227.5 |
| 1960-61 | 40.4 | 43.9 | 16.9 | 101.2 | 95.99 | 22.5 | 29.53 | 147.67 | 248.87 |
| 1961-62 | 40.2 | 48.5 | 19.4 | 108.1 | 97.29 | 22.44 | 29.93 | 149.64 | 257.74 |
| 1962-63 | 49.1 | 54.5 | 22.6 | 126.2 | 98.40 | 22.70 | 30.28 | 151.38 | 277.58 |
| 1963-64 | 48.6 | 56.2 | 25.2 | 130.0 | 101.54 | 23.43 | 31.25 | 156.22 | 286.22 |
| 1964-65 | 48.2 | 60.4 | 27.8 | 136.4 | 102.78 | 23.72 | 31.62 | 158.12 | 294.52 |
| 1965-66 | 51.8 | 64.6 | 30.6 | 147.0 | 106.23 | 24.51 | 32.69 | 163.43 | 310.43 |
| 1966-67 | 52.3 | 69.1 | 33.2 | 154.5 | 108.50 | 25.04 | 33.38 | 166.92 | 321.42 |
| 1967-68 | 54.5 | 73.3 | 36.8 | 164.6 | 111.07 | 25.63 | 34.17 | 170.87 | 335.47 |
| 1968-69 | 53.0 | 82.3 | 41.5 | 176.8 | 112.61 | 25.99 | 34.64 | 173.24 | 350.04 |
| 1969-70 | 56.66 | 90.06 | 45.02 | 191.74 | 114.24 | 26.37 | 35.15 | 175.76 | 367.50 |
| 1970-71 | 51.35 | 97.19 | 48.65 | 197.19 | 116.62 | 26.91 | 35.88 | 179.41 | 376.60 |

Notes: See Table 1. For equivalence units, see Table 6.

Table 3. Sectorwise and sourcewise consumption of commercial energy (1970-71) (millions of tonnes coal equivalent).

| Source | Sector | Mining and Manufacturing | Transport | Domestic | Agricultural | Others | Total |
|--------------------|--------|--------------------------|-----------|----------|--------------|--------|--------|
| Coal ¹⁾ | (a) | 60.50 | 31.00 | 7.92 | - | 0.58 | 100.00 |
| | (b) | 31.07 | 15.91 | 4.07 | - | 0.30 | 51.35 |
| | (c) | 40.71 | 24.84 | 11.47 | - | 2.55 | 26.00 |
| Oil ²⁾ | (a) | 22.22 | 48.59 | 28.38 | 4.04 | 7.17 | 100.00 |
| | (b) | 10.90 | 47.23 | 27.58 | 4.51 | 6.97 | 97.19 |
| | (c) | 14.28 | 73.15 | 77.73 | 49.83 | 59.22 | 49.30 |
| Electricity | (a) | 70.61 | 2.94 | 7.87 | 9.33 | 9.25 | 100.00 |
| | (b) | 34.35 | 1.43 | 3.83 | 4.54 | 4.50 | 48.65 |
| | (c) | 45.01 | 2.21 | 10.80 | 50.17 | 38.23 | 24.70 |
| Total | (a) | 38.87 | 32.45 | 18.07 | 4.61 | 5.99 | 100.00 |
| | (b) | 76.32 | 64.57 | 35.48 | 9.05 | 11.70 | 197.19 |
| | (c) | 100.00 | 100.00 | 100.00 | 100.00 | 100.00 | 100.00 |

Notes: (a) = Percentage consumption of fuel in different sectors.
 (b) = Millions of tonnes, coal equivalent.
 (c) = Percentage consumption of different fuels in a particular sector.

¹⁾ Coal figures exclude coal used for electricity generation.

²⁾ Oil figures exclude products used for non-energy purposes.

Table 4. Villages electrified in India.

| Population range (1961 census) | Total | Number Electrified as of | | | | | 31/3/70 |
|-----------------------------------|----------------|--------------------------|---------------|---------------|---------------|---------------|---------|
| | | 31/3/51 | 31/3/61 | 31/3/66 | 31/3/69 | 31/3/70 | |
| (1) | (2) | (3) | (4) | (5) | (6) | (7) | |
| up to 499 | 351,653 | 522 | 3,986 | 10,265 | 19,934 | 26,222 | |
| 500 to 999 | 119,086 | 611 | 4,306 | 9,787 | 17,226 | 21,775 | |
| 1,000 to 1,999 | 65,377 | 843 | 5,918 | 11,567 | 18,128 | 22,504 | |
| 2,000 to 4,999 | 26,565 | 825 | 5,458 | 9,411 | 12,913 | 15,948 | |
| 5,000 to 9,999 | 3,421 | 197 | 1,319 | 1,963 | 2,397 | 2,638 | |
| 10,000 and above | 776 | 134 | 560 | 647 | 682 | 693 | |
| Total | 566,878 | 3,132 | 21,547 | 43,640 | 71,280 | 89,780 | |

Note: 1. The data for electrified villages of Punjab and partly of U.P. is based on 1951 census.

2. The data of electrified villages of Tamilnadu up to 31.3.61 is only based on the 1951 census and therefore the population breakdown for all periods is up to 31/3/61.

3. The population breakdown of electrified villages and other figures have been estimated wherever actual figures are not available.

Source: F.P.C. Committee Report.

Table 5. Pumpsets and electrical energy consumption.

| Year | No. of sets in operation | Total connected load (MW) | Energy consumption (10 ⁶ kwh) | Consumption per pumpset (kwh) | Consumption in kwh per kw of connected load |
|-----------------------------|-----------------------------|---------------------------------|--|-------------------------------------|--|
| (1) | (2) | (3) | (4) | (5) | (6) |
| 1966-67 | 649,182 | 2,501 | 2,107 | 3,245 | 842 |
| 1967-68 | 847,357 | 3,175 | 2,585 | 3,050 | 814 |
| 1968-69 | 1,088,774 | 4,155 | 3,466 | 3,183 | 834 |
| 1969-70 | 1,342,006 | 5,106 | 3,770 | 2,809 | 738 |
| 1970-71 | 1,642,006 | 6,254 | 4,110 | 2,503 | 657 |
| on 31/3/74 (anticipated) | 2,444,599 | | | | |
| on 31/3/79 (target) | 4,022,790 | | | | |

Table 6. Estimated domestic consumption patterns in urban and rural areas: 1962-63.

| | Delphi, Bombay Calcutta | | Other urban areas | | Rural areas | | Total |
|--|----------------------------|---------------|----------------------|--------------|---------------|--------------|---------------|
| | (a) | (b) | (a) | (b) | (a) | (b) | |
| Commercial Fuels | | | | | | | |
| Kerosene | 1.20 | 29.9 | 3.80 | 13.9 | 10.70 | 7.8 | 15.70 |
| Soft coke | 0.90 | 22.4 | 0.40 | 1.5 | 1.30 | 0.9 | 2.60 |
| Electricity | 0.58 | 14.5 | 0.88 | 3.3 | 0.23 | 0.2 | 1.70 |
| Total | 2.68 | 66.8 | 5.09 | 18.7 | 12.23 | 8.9 | 20.00 |
| Non-commercial Fuels | | | | | | | |
| Firewood and Charcoal | 1.25 | 31.2 | 14.18 | 51.9 | 81.33 | 59.4 | 96.76 |
| Dungcakes | 0.04 | 1.0 | 3.42 | 12.5 | 18.50 | 13.5 | 21.96 |
| Waste products | 0.04 | 1.0 | 4.62 | 16.9 | 24.96 | 18.2 | 29.62 |
| Total | 1.33 | 33.2 | 22.22 | 81.3 | 124.79 | 91.1 | 148.34 |
| Grand Total | 4.01 | 100.00 | 27.31 | 100.0 | 137.02 | 100.0 | 168.34 |
| Consumption per Head ¹⁾ (tonnes) | 0.41 | | 0.39 | | 0.38 | | 0.38 |

Note: (a) = Total consumption, tonnes coal equivalent.

(b) = Percent of total.

1) One tonne of soft coke required for manufacturing and thus = 1.50 tonnes of coal. One tonne of dried dung replaces 0.27 tonnes of soft coke = 0.40 tonnes of coal. One tonne of firewood replaces 0.63 tonnes of soft coke = 0.95 tonnes of coal. One tonne of waste products replaces 0.63 tonnes of soft coke = 0.95 tonnes of coal. One tonne of kerosene replaces 4.33 tonnes of soft coke = 6.50 tonnes of coal.

Table 7. NSS estimates of domestic energy consumption in coal equivalent.

| | Rural kgce/year ¹⁾ | Urban kgce/year ¹⁾ |
|-------------|----------------------------------|----------------------------------|
| Coke | 2.48 | 25.00 |
| Coal | 3.53 | 12.90 |
| Firewood | 256.00 | 160.00 |
| Electricity | 0.36 | 9.00 |
| Gas | - | 0.79 |
| Dingcake | 40.00 | 13.30 |
| Charcoal | 6.30 | 4.20 |
| Kerosene | 28.70 | 51.60 |
| Other fuels | 9.35 | 3.35 |

¹⁾ kgce = kilogram of coal equivalent.

Table 8. Demographic and economic characteristics for 2000-01.

| | |
|--|-------|
| 1. Total population in millions | 1,110 |
| 2. With | |
| Urban population | 310 |
| Rural population | 800 |
| 3. National Income in billions of Rs (in 1960-61 prices) | 725 |
| 4. Per Capita Income (Rs/Year) (in 1960-61 prices) in | 655 |
| Urban areas | 762 |
| Rural areas | 610 |
| 5. Foodgrain demand in million tonnes | 475 |
| 6. Nitrogenous fertilizers required (in million tonnes of nitrogen) | 13.5 |
| 7. Energized pumpsets (in millions) | 35 |

Table 9. Efficiency of photo-synthesis
in utilizing solar energy.

| Crop | Approximate yield per acre (ton) | Average duration of the growing season | Percentage of total solar radia- tion received during the growing season actually utilized |
|----------------|--|--|---|
| (1) | (2) | (3) | (4) |
| Wheat | 3 | 120 days | 0.44 |
| Paddy | 8 | 120 days | 1.17 |
| Gower (millet) | 12 | 120 days | 1.76 |
| Sugarcane | 40 | 12 months | 2.00 |

Source: Report of the NCST panel on Solar Energy.

Table 10. Fuels saved by installing twelve million bio-gas plants of 100 ft³ each to meet the fuel needs of ninety million people.

| Fuel | Unit | Consumption/ person over thirty days | Consumption/ person over 365 days | Consumption for year for ninety million persons |
|-------------|------|--|---|--|
| (1) | (2) | (3) | (4) | (5) |
| Coke | kg | .20 | 2.44 | .22 mt |
| Coal | kg | .19 | 2.33 | .21 mt |
| Firewood | kg | 22.06 | 269.00 | 24.20 mt |
| Electricity | kwh | .05 | .61 | .055 bkwh |
| Dungcakes | kg | 9.39 | 114.53 | 10.3 mt |
| Kerosene | kg | .39 | 4.76 | .43 mt |

Table 11. Domestic energy requirements with emphasis on bio-gas plants.

| | | |
|----|------------------------|----------|
| 1. | <u>Urban Needs</u> | 124 mtce |
| | a) LPG | 24 mtce |
| | b) Kerosene | 30 mtce |
| | c) Electricity | 12 mtce |
| | d) Coal | 50 mtce |
| | e) Firewood | 8 mtce |
| 2. | <u>Rural Needs</u> | 304 mtce |
| | a) Bio-gas | 228 mtce |
| | b) Coal | 10 mtce |
| | c) Firewood | 40 mtce |
| | d) Agricultural wastes | 26 mtce |

Table 12. Rural domestic energy alternatives.

| (in mtce) | | | | |
|------------------------------|----------------------------|---|--|--|
| Items | Strategies with account on | | | |
| | Conventional fuels | Fuel wood planta- tions | Family sized bio- gas plants | Community sized bio- gas plants |
| (1) | (2) | (3) | (4) | (5) |
| Fuel Source | | | | |
| (a) Bio-Gas | - | - | 34 | 228 |
| (b) Kerosene | 40 | 6 | 36 | - |
| (c) Coal | 10 | - | 10 | 10 |
| (d) Electricity | 26 | 26 | 25 | - |
| (e) Firewood | 123 | 272 | 111 | 40 |
| (f) Dung | 67 | - | 50 | - |
| (g) Agricultural wastes | 38 | - | 38 | 26 |
| Total Rural Needs | 304 | 304 | 304 | 304 |
| Remarks | - | Needs 24 million hectares of land. | Needs Rs 3.00 crores for 12 million 100 ft ³ plants | Needs Rs 1.16 crores for 1.45 million ³ 5,000 ft plants |

Table 13. Estimated requirements of fuels
(in original units).

| | Coal ¹⁾ | Oil ¹⁾ | Electric- ity 10 ⁹ kwh | Firewood 10 ⁶ tonne | Animal Dung 10 ⁶ tonne | Agri- cultural waste 10 ⁶ tonn |
|---------------|--------------------|-------------------|---|--------------------------------------|--------------------------------------|--|
| | (1) | (2) | (3) | (4) | (5) | (6) |
| 1970-71 | 66 | 18 | 56 | 123 | 67 | 38 |
| <u>Case A</u> | | | | | | |
| 2000-01 | 600 | 147 | 670 | 89 | 40 | 46 |
| <u>Case B</u> | | | | | | |
| 2000-01 | 650 | 97 | 700 | 89 | 40 | 46 |

¹⁾Including coal and oil used in generating electricity and in the non-energy sector.

Table 14. Requirements for coal and lignite.

| Sectors | 2000-01 | |
|---|-----------|-----------|
| | Case a | Case b |
| (1) | (2) | (3) |
| 1. Steel plants and coke ovens ¹⁾ | 190 | 190 |
| 2. Thermal power generation ²⁾ lignite required | 172 17 | 190 17 |
| 3. Railways | 10 | 10 |
| 4. Industries | 90 | 105 |
| 5. Brick burning | 50 | 50 |
| 6. Domestic coke ¹⁾ | 50 | 60 |
| 7. Export | 5 | 5 |
| 8. Collieries' own consumption | 19 | 19 |
| 9. Fertilizer | 14 | 20 |
| 10. Total cost production | 617 | 666 |

¹⁾ These are in terms of raw coal.

²⁾ This excludes middlings which are included under steel plants. Middling availability is: 5 mt, 12 mt, 21 mt, 49 mt.

Table 15. Requirements of electricity.

| | (billion kwh) | |
|--------------------------------------|---------------|--------------|
| | 2000-01 | |
| | Case a | Case b |
| 1. Major industrial consumption | 300.0 | 300.0 |
| 2. Other industrial consumption | <u>100.0</u> | <u>100.0</u> |
| 3. Total industrial consumption | 400.0 | 400.0 |
| 4. Domestic consumption | 38.0 | 40.0 |
| 5. Commercial consumption | 45.0 | 45.0 |
| 6. Public lighting | 6.0 | 6.0 |
| 7. Traction (Railways) | 19.0 | 25.0 |
| 8. Irrigation and dewatering | <u>62.0</u> | <u>77.0</u> |
| 9. Total consumption | 570.0 | 593.0 |
| 10. Losses and Auxiliary consumption | <u>100.0</u> | <u>107.0</u> |
| 11. Total generation required | 670.0 | 700.0 |

The peak loads at a load factor of 0.65 would be 118,000 MW. and 123,000 MW for case A and case B respectively. This will be made up of different types of plants as follows.

| | Installed capacity in 2000-01 | | | Total |
|--------|-------------------------------|---------|--------|---------|
| | Hydro | Nuclear | Coal | |
| Case A | 60,000 | 25,000 | 70,000 | 118,000 |
| Case B | 60,000 | 25,000 | 77,000 | 123,000 |

Table 16. Requirements for oil products.

| Name of products | 2000-01 | |
|---|--------------|-------------|
| | Case a | Case b |
| 1. <u>Energy Sector</u> | | |
| LPG | 3.0 | 3.0 |
| Motor Gas | 5.0 | 4.4 |
| Kerosene | 9.6 | 8.0 |
| ATF | 9.8 | 7.0 |
| HSDO | 66.2 | 38.3 |
| LDO | 6.0 | 4.4 |
| Furnace Oil | | |
| a) Used for power generation and Industries | 16.5 | 9.5 |
| b) Coastal Bunkers | 1.2 | 1.2 |
| c) International Bunkers | 1.0 | 1.0 |
| d) Others | 1.2 | 1.2 |
| Total (1) | <u>119.5</u> | <u>78.0</u> |
| 2. <u>Other Than Energy Sector</u> | | |
| Naphtha | 7.5 | 6.5 |
| FO for Feedstock for fertiliser | 5.0 | 3.0 |
| Lubes | 2.0 | 2.0 |
| Bitumen | 8.5 | 5.0 |
| Others | 2.5 | 2.5 |
| Total (2) | <u>25.5</u> | <u>19.0</u> |
| Grand Total (1) + (2) | <u>145.0</u> | <u>97.0</u> |

Table 17. Substitution summary.

| | Fuel in case a | REPLACED ← BY → | Fuel in case b |
|----------------------|--|--------------------|---|
| Domestic | 1.6 mt of kerosene | | 2.0 bkwh of electricity plus 7.0 mt of coke obtained from 10 mt of coal |
| Industry | 7.0 mt of furnace oil | | 14.0 mt of coal |
| Fertilizer Feedstock | 1.0 mt of naphtha 2.0 mt of furnace oil | | 6.0 mt of coal |
| Agriculture | 1.6 mt of LDO and 0.4 mt of HSDO | | 15.0 bkwh |
| Transport | 0.6 mt of mogas 2.8 mt of ATF 28.6 mt of HSDO used in road transport | | Traffic shifted to public buses, air traffic discouraged and shifted to trains. 1.1 mt of HSDO and 6 bkwh used for rail transport. |
| Construction | 3.5 mt of bitumen | | Reduced need because of reduction in road traffic. |
| Total | 49.1 mt of oil products | | 23 bkwh of electricity plus 38.1 mt of coal. |

Discussion

Hoffmann

Parikh gave data from India of which I was not aware before, especially the estimates of energy consumption for the year 2000. In the FRG, we think of annual growth rates for electricity consumption of about 5%, and some institutions think the rate will be even lower. If I have calculated correctly, Parikh assumes a growth rate of 9% per annum and similar growth rates for coal production. India has large resources of coal, but present coal production is just about equal to that of the FRG. How can one expect coal production to rise ten times by the year 2000? How will this coal come out of the earth?

Neu

I would like to ask Parikh why solar energy was not considered as one of the options for the future.

Häfele

I had a specific question for Parikh: What is the most active constraint in building up an energy economy? Are you essentially capital constrained? You need energy to get the economy growing, and the growing economy in turn requires capital for energy production. This is the vicious cycle of economic development. But there are other factors of production like labor, materials, education, etc.

Parikh

I feel that it is true that one would need energy in order to have economic progress in itself; otherwise you will not be able to increase productivity. But I think the most serious constraint is getting investable surpluses, or getting the savings rate up. If you look at the last twenty-five years' performance, the Indian economy has been growing at an average

annual growth rate of 3% to 3.5%. This really does not leave much of a surplus to reinvest. Now one would like to make an allocation of energy to various other activities such as steel, mechanical fertilizer plants, and irrigation. All this would have to be done in a global optimizing system where you allocate your resources to the different sectors.

Häfele

While I appreciate the answer by Parikh, I must interject two observations. In the energy studies conducted here at the Institute, we found that solar energy is by far too expensive. Excluding transportation and distribution, one at best comes up with less than \$2,000/kw, whereas nuclear power is about \$500/kw. For coal mining the capital investments may be even smaller, and one may be able to produce electricity at \$200/kw. Therefore, while I sympathize with the use of solar energy, I think that its capital requirements are much higher than those for the other fuels.

Parikh

I presented to you only that portion of the study which deals with currently available technology. But I have considered the implications of having solar energy in my detailed study. Suppose you were to use solar energy for irrigation purposes only, using a solar low-temperature pump. If this pump is to cost you no more than a conventional electric-diesel pump, then you need to have a solar collector, around Rs 70 per square meter (\$10 per square meter).

Häfele

By rough calculation, \$10 per square meter means solar energy costs of about \$500/kw.

Parikh

May I come back to the earlier comment about coal? Most of India's coal reserves are shallow, and projections have been

made that it is possible to mine something like 600 million tons of coal annually. This assumes that 50% will come from open mines, 40% from shallow underground mines which are defined as those up to 200 metres, and the remaining 10% would come from deep open pit mines with a depth greater than 200 metres.

The capital requirements per ton of coal depend upon whether the mines are in the public or in the private sector. Investment per ton per year capacity for a shallow mine, less than 200 meters, would be Rs 80 to Rs 120 (or \$10 to \$15) per ton capacity. For deep underground mines it would be more like \$13 to \$22 per ton capacity.

Häfele

This means that the capital costs for coal mining are by far smaller than for any other option. Also, coal is relatively labor intensive, and because of a lack of capital you would largely go into coal.

Parikh

Correct, this is precisely the idea. The Indian coal mining industry is very labor intensive. The digging is done with pick and shovel. Last year in a pinch, when they wanted to increase the coal production by a few million tons in a year, all that was done was to provide the workers in a few mines with hand drills, and the output of coal increased by eight million tons per year, an increase of ten percent.

Woitte

May I raise one question related to the discussion with Parikh? One way to find an optimum development pattern in a country as yours with severe capital constraints is to define a discount rate or rate of capital return which adequately reflects this capital scarcity. In the Soviet Union they are applying a 12% discount rate (in real terms) and you also quoted a number like this. Does this rate adequately reflect your capital scarcity?

Parikh

There is no one officially prescribed discount rate that is prevailing in the country. Reports by the Planning Commission evaluate projects with rates between 10% and 20%. My personal guess is that with the available capital resources a 20% discount rate is probably nearer the correct rate.

IV. INTERNATIONAL STUDIES



The Demand for Energy: An International Perspective¹

William D. Nordhaus

I. Introduction

Problems of energy are today at the center stage of political and economic affairs. In the short run, the industrialized world is attempting to cope with a radical restructuring of energy price levels and the world depression and to rechannel the flow of funds that the price changes induce. In the medium run, many countries or regions (especially the United States, the European Community, and Japan) are attempting to insulate themselves from the vicissitudes of the international energy market by increasing their self-sufficiency. For the longer run, groups such as IIASA are investigating the problems of transition from scarce, low-cost fossil fuels to higher-cost but more abundant fuels.²

The two cornerstones of the uncertainties which run through all these studies are the future technology and the proper specification of the demand for energy. Up to now, most work in energy systems analysis--at IIASA as well as in most other institutions--has been on the question of technology and supply. Recently, however, the rapid changes

¹The present study was supported by the International Institute for Applied Systems Analysis, the United States National Science Foundation, and the Cowles Foundation. Many persons helped in its preparation: Mr. Paul Krugman, Mrs. Truus Koopmans, and Mrs. Claire Doblin worked on gathering the underlying data; Mr. Bernhard Schweeger skillfully supervised the data processing and regression analysis; and Mrs. Lilo Roggenland typed the first manuscript with great patience. None of the above institutions or individuals are responsible for errors or opinions presented in the study.

²Examples of the short-term approach are [8, 15, 28]; examples of the medium-term approach are [27, 33, 35, 48, 50]; and examples of the long-term approach are [22, 29, 31, 37, 44, 49].

in price and the current economic crisis has shifted emphasis to the demand side of the equation, with special reference to the possibilities of "energy conservation."

The central uncertainties in energy demand are four: First, as far as the long-run is concerned, what is the income elasticity of the demand for energy; that is, with a given rate of growth in the aggregate output of an economy, what is the fractional increase of the demand for energy? Second, relating mainly to the medium term, what is the long-run price elasticity of the demand for energy? Especially given the dramatic changes in the relative prices of energy to other goods, it is of central importance to know what the eventual response of energy demand will be. How will energy demand respond to further policy measures? Third, in the short run, the critical question is what is the time distribution of the response to the recent price increases? Fourth, it is implicit in the questions usually raised that energy is a conventional economic good, in the sense that it responds to the laws of supply and demand in the same way that most other goods do; many have argued that energy is unique, indeed that it is the ultimate determinant of value, and that we cannot hope to explain the behavior of the demand for energy with conventional econometric models. Is this so?

In what follows I will address myself to each of the problems given above. The framework for analyzing the question is to employ simple econometric techniques, these for estimating "economic demand functions." A technical description will be provided in the next section, while results and interpretation will be provided in subsequent sections.

It should be stressed that the results presented here are preliminary: the data have not been thoroughly rechecked, and it is possible that errors have crept in.

II. Specification of the Econometric Model

The problem of estimating the demand for energy is

conceptually difficult because energy is a derived demand rather than a final demand; that is, energy is demanded not for its own sake but because it can be combined with other inputs to produce satisfaction-yielding services. (As an example, consider the energy used in running an air conditioner.) This implies that the important factors will be both those determining the demand for final products (such as cool air in summer) as well as the competition between inputs into the productive process (as between the capital and fuel costs of air conditioners and fans). The technique outlined here specifies the way that demand and technology interact so as to determine the derived demand for energy inputs.

The bases for the estimation are two fundamental relations: A) the technology and B) the preference relations. Through the interaction of these two relations the price and demand for the energy products are determined.

The important assumptions are given first:

- 1) There is a well-behaved production function for each good, where the inputs are capital, labor, and energy.
- 2) Energy is aggregated in each sector into a single entity, although the type of fuel used in different sectors may differ and the efficiencies of fuels do differ.
- 3) Sectors are assumed to minimize the costs of production for a given level of output.
- 4) The residential sector is divided into a production department and a consumption department, so that we consider the residential demand for energy mediated through the production department of the residential sector.

- 5) Prices are assumed to be set by marking up long-run average cost by a fixed markup (which would be zero for competitive industries).
- 6) The forces influencing demand can be represented by a consistent preference function.

From these assumptions, it is shown how the demand for energy inputs is related to parameters of the production and preference functions, to prices, and to incomes.

Mathematical Derivation

The notation below uses the following convention:

- capital Roman letters (A, B, C, D) are economic variables;
- small Roman letters (a, b, c, d) are logarithms of economic variables; and
- parameters are represented by Greek letters (α , β , γ , ...). Vectors are underlined ($\underline{\alpha}$, $\underline{\beta}$, ...) while scalars are not underlined (ϵ , γ).

First consider the role of energy in production.

Consider an economy with primary factors labor L, energy E, and capital K, and with produced goods Q_1, \dots, Q_n . The production function for good i is:

$$Q_i = F^i(Q_{1i}, \dots, Q_{ni}, L_i, K_i, E_i, T) \quad (1)$$

which can be approximated in a Taylor expansion by:

$$q_i = h_i^0 + \sum_{j=1}^n \alpha_{ji} q_j + \beta_i^0 l_i + \gamma_i^0 e_i + \delta_i^0 k_i + \lambda_i^0 T \\ + \text{higher order terms} \quad (2)$$

In (2) h_i^0 are constants, T is time--a proxy for change in technology. The parameters before factors are the production

elasticities, quite similar to the input-output coefficients in a (linear) input-output model. In the CES or in the "translog" production function, the higher order terms would be included, but in what follows we will be satisfied with the first order terms. This makes the production function the well-known Cobb-Douglas vintage.³

Next, represent equation (2) in vector form by introducing the vectors and matrices as follows (suppressing superscripts):

$$\underline{q} = \begin{bmatrix} q_1 \\ \vdots \\ q_n \end{bmatrix} \quad \underline{l} = \begin{bmatrix} l_1 \\ \vdots \\ l_n \end{bmatrix} \quad \underline{k} = \begin{bmatrix} k_1 \\ \vdots \\ k_n \end{bmatrix} \quad \underline{e} = \begin{bmatrix} e_1 \\ \vdots \\ e_n \end{bmatrix} \quad \underline{\lambda} = \begin{bmatrix} \lambda_1 \\ \vdots \\ \lambda_n \end{bmatrix} \quad \underline{h} = \begin{bmatrix} h_1 \\ \vdots \\ h_n \end{bmatrix}$$

$$\underline{\alpha} = \begin{bmatrix} \alpha_{11} & \dots & \alpha_{n1} \\ \vdots & & \vdots \\ \alpha_{1n} & \dots & \alpha_{nn} \end{bmatrix} \quad \underline{\beta} = \begin{bmatrix} \beta_1 & \dots & 0 \\ 0 & & \vdots \\ 0 & \dots & \beta_n \end{bmatrix} \quad \underline{\gamma} = \begin{bmatrix} \gamma_1 & \dots & 0 \\ \vdots & & \vdots \\ 0 & \dots & \gamma_n \end{bmatrix} \quad \underline{\delta} = \begin{bmatrix} \delta_1 & \dots & 0 \\ \vdots & & \vdots \\ 0 & \dots & \delta_n \end{bmatrix}$$

Then we can rewrite equation (2) as:

$$\underline{q} = \underline{h}^0 + \underline{\alpha}\underline{q} + \underline{\beta}^0\underline{l} + \underline{\gamma}^0\underline{e} + \underline{\delta}^0\underline{k} + \underline{\lambda}T \quad (3)$$

or solving for \underline{q} :

$$\underline{q} = \underline{h} + \underline{\beta}\underline{l} + \underline{\gamma}\underline{e} + \underline{\delta}\underline{k} + \underline{\lambda}T \quad , \quad (4)$$

where

$$\begin{bmatrix} \underline{h} \\ \underline{e} \\ \underline{\gamma} \\ \underline{\delta} \\ \underline{\lambda} \end{bmatrix} = [\underline{I} - \underline{\alpha}]^{-1} \begin{bmatrix} \underline{h}^0 \\ \underline{e}^0 \\ \underline{\gamma}^0 \\ \underline{\delta}^0 \\ \underline{\lambda} \end{bmatrix}$$

³For a discussion of the application of translog (or non-linear logarithmic systems) production and utility functions see [36] and [35].

and \underline{I} is the identity matrix. We thus reduce each production function to a Cobb-Douglas function in primary factors.

Next, note that cost functions exist as dual functions to the production function.⁴ Let c_i = logarithm of cost, then

$$c_i = C^i(p_\ell, p_e, p_k, T) = \beta_i p_\ell + \gamma_i p_e + \delta_i p_k - h_i - \lambda_i T \quad (5)$$

where p_ℓ , p_e , and p_k are the logarithms of the service prices of L, E, and K, and all other parameters are the same as in the production function. A "translog" function would, in addition, add second order terms [e.g. $p_k^2, p_k p_\ell, \dots$], but these are again ignored.⁵

In vector form, (5) becomes

$$\underline{c} = \underline{\beta} p_\ell + \underline{\gamma} p_e + \underline{\delta} p_k - \underline{h} - \underline{\lambda} T \quad (6)$$

It is important to note that the mathematical duality of cost and production functions implies the very close similarity between the production function in (4) and the cost function in (6).

Up to now the discussion has focused only on the characterization of the technology and cost functions. In most economies, those who purchase or demand products are not aware of these functions. Rather, they are faced with a combination of price and quantity signals, indicating the relative scarcity of different goods. In what follows, we assume that markets are cleared by the use of explicit or

⁴See Shepard [57].

⁵The work of Jorgenson and his collaborators (see [35] for example) estimates the production function by working with the dual function as in (5).

implicit pricing, and that the pricing is cost based. Producers are assumed to price products on the basis of average cost, where they recover their average cost plus a fixed markup.⁶ In addition, it is assumed that the government levies excise taxes on products. These imply that the price is given by:

$$p_i = c_i + \sigma_i \quad (7)$$

where

σ_i is the sum of the markup and the excise tax.⁷

The second fundamental relation is the preference function. It is assumed that society's preferences can be represented by a well-behaved function over the final products of the society, more precisely that a preference function exists of the form $U = U(Q_1, \dots, Q_n)$. This can be derived either from market demand functions for decentralized economies or sectors, or from the preferences of the planners or representatives in a centralized economy or sector.⁸ The major assumptions are that such a function exists, that it is well-behaved, and that the agents of the economy act (at least in the long run) to attain the most preferred set of goods. Assuming that these conditions are met, the demand functions of the economy can be represented as $Q_i = D^i(P_1, \dots, P_n, Y)$, $i = 1, \dots, n$, where P_i are again the prices and Y is the total income. Other variables (weather, distribution of income, form of

⁶In a Cobb-Douglas production function, the marginal cost is a constant fraction of average cost. In a constant returns to scale technology average and marginal cost are equal.

⁷Strictly speaking, we are assuming that the sum of product of (1 + the excise tax rate) and (1 + the markup) is $\exp(\sigma_i)$.

⁸See Tsvetanov and Nordhaus [62].

government) are built into the D functions. Similarly to the production function, we can represent the demand relations as:

$$q_j = \theta_j + \sum \psi_{ij} p_i + \mu_j Y + \text{higher order terms} \quad . \quad (8)$$

There are in addition certain restrictions on the functions imposed by the budget constraint, but these will be ignored for the moment. Again we ignore higher order terms. In vector form (8) is:

$$\underline{q} = \underline{\theta} + \underline{\psi} \underline{p} + \underline{\mu} Y \quad (9)$$

where $\underline{\theta}$ and $\underline{\mu}$ are column vectors and $\underline{\psi}$ is a nxn matrix of price elasticities. Also note that $\underline{\theta}$ is a function of non-price variables, as well as random terms. Solving (9) using (6) and (7)

$$\underline{q} = \underline{\theta} + \underline{\psi} [\underline{\beta} p_\ell + \Upsilon p_e + \underline{\delta} p_k - \underline{h} - \underline{\lambda} T + \underline{\sigma}] + \underline{\mu} Y$$

or

$$\begin{aligned} \underline{q} = \underline{\theta} + \underline{\beta}^* p_\ell + \Upsilon^* p_e + \underline{\delta}^* p_k - \underline{h}^* - \underline{\lambda}^* T + \underline{\sigma}^* \\ + \underline{\mu} Y \end{aligned} \quad (10)$$

where an asterisk indicated premultiplication by $\underline{\psi}$ (e.g. $\underline{\beta}^* = \underline{\psi} \underline{\beta}$).

Finally we need to determine the demand for individual factors. Assuming cost minimization, the first order conditions are:

$$e_i + p_e - \gamma_i' = \ell_i + p_\ell - \beta_i' = k_i + p_k - \delta_i' \quad , \quad (11)$$

each i , where $\gamma_i' = \log(\gamma_i)$ and so forth.

Equations (10), (11) and (4) give $4n$ equations for $4n$ variables $[q_i, e_i, l_i, k_i]$. We wish to solve for energy demand in each sector, e_i . Using (11), eliminate l_i and k_i :

$$\left. \begin{aligned} l_i &= e_i + p_e - \gamma_i' + \beta_i' - p_l \\ k_i &= e_i + p_e - \gamma_i' + \delta_i' - p_k \end{aligned} \right\} \text{ each } i = 1, \dots, n \quad (12a)$$

$$(12b)$$

Putting (12a) and (12b) into (4):

$$\begin{aligned} q &= \beta[e + p_e - \gamma' + \beta' - p_l] + \underline{\gamma}e + \delta[e + p_e \\ &\quad - \gamma' + \delta' - p_k] + \underline{h} + \lambda T \end{aligned}$$

or

$$\begin{aligned} \underline{q} &= [\beta + \gamma + \delta]e + [\beta + \delta]p_e - \beta p_l - \delta p_k \\ &\quad + \gamma T + A^0 \end{aligned} \quad (13)$$

where

$$A^0 = [\underline{h} + \beta\beta' - \beta\gamma' + \delta\delta' - \delta\gamma'] \quad .$$

Solving (13) and (10):

$$\begin{aligned} &(\beta + \gamma + \delta)e + (\beta + \delta)p_e - \beta p_l - \delta p_k + \lambda T + A^0 \\ &= \underline{e} + \beta^* p_l + \gamma^* p_e + \delta^* p_k + \underline{\mu}y - \underline{h}^* - \lambda^* T + \underline{\sigma}^* \end{aligned} \quad (14)$$

or finally

$$\begin{aligned}
e = & \underline{A}^+ + [\underline{\gamma}^{+*} - \underline{\beta}^+ - \underline{\delta}^+]p_e + (\underline{\beta}^{+*} + \underline{\beta}^+)p_\ell \\
& + (\underline{\delta}^{+*} + \underline{\delta})p_k + \underline{\mu}^+Y - (\underline{\lambda}^{+*} + \underline{\lambda}^+)T \quad (15)
\end{aligned}$$

where the $^+$ indicated premultiplication by $(\underline{\beta} + \underline{\gamma} + \underline{\delta})^{-1}$, the * indicated premultiplication by ψ , and $\underline{A} = \underline{\sigma}^* - \underline{h}^* - \underline{A}^0 + \underline{\theta}$. Equation (15) will be called the energy demand equation.

Remarks

The specification used in equation (15) is at the same time very highly oversimplified and yet very difficult to estimate. Some remarks about its properties will help understanding of the econometric results.

a) In the simplest case, assume that each industry has constant returns to scale (so that $\beta_i + \gamma_i + \delta_i$ equals unity); that the demand elasticity matrix is diagonal; and that there is no interdependency, so that the logarithmic input-output coefficients in (2) are zero for all but primary factors. In this case the demand equation reads:

$$\begin{aligned}
e_i = & A_i + [\psi_{ii}\gamma_i - \beta_i - \delta_i]p_e + [\psi_{ii}\beta_i + \beta_i]p_\ell \\
& + [\psi_{ii}\delta_i + \delta_i]p_k + \mu_i Y \quad (16)
\end{aligned}$$

for all $i = 1, \dots, n$, or for simplicity:

$$e_i = c_{0i} + c_{1i}p_e + c_{2i}p_\ell + c_{4i}p_k + c_{3i}Y \quad (16a)$$

b) In the econometric estimates that follow we further simplify the structure to make the equations easier to interpret. Note that the price of capital services is $P_k = (r + v)P_c$, where r is the appropriate discount rate, v is the depreciation rate, and P_c is the price of capital goods. In what follows we assume that the price of capital goods is linearly related

to the price of GNP, or that $P_c \sim P$, where P is the GNP deflator.⁹ Further assume that $(r + v)$ is constant over time. Finally we make note of the fact that labor's share in national income is relatively stable in space and time. This fact makes it difficult to distinguish between p_ℓ and y in our basic equation. To circumvent this problem we use the equation that the price of labor is proportional to the product of the GNP deflator and per capita output, or¹⁰

$$p_\ell = \text{constant} + y \cdot \quad (17)$$

Substituting into (16a) and using the fact that $\gamma_i + \beta_i + \delta_i = 1$ we obtain

$$e_i = c'_{0i} + c_{1i}p_e + (c_{2i} + c_{3i})y + c_{4i}p \quad .$$

Note that by the basic homogeneity of degree zero of equation (16) we have that $c_1 + c_2 + c_3 + c_4 = 0$, so we can rewrite as:

$$e_i = c'_{0i} + c_{1i}p_e + (c_{2i} + c_{3i})y - (c_{1i} + c_{2i} + c_{3i})p \quad ,$$

or in final form

⁹This assumption is theoretically justified if the energy and labor intensities of capital are equal to the energy and labor intensities of non-capital goods. This is roughly so. On an empirical level, capital goods prices are quite closely related to other goods according to the data collected for this project.

¹⁰Kendrick and Sato [38] and Denison [19] give evidence on the constancy of labor's share. If labor's share is a constant fraction of GNP we have $p_\ell L = C_1 P \cdot X$, where X is GNP. If the labor force participation rate is constant then $L/\text{Pop} = C_2$, where Pop is population. Thus we can relate per capita income ($Y = PX/\text{Pop}$) and wages (P_ℓ) as:

$$Y = PX/\text{Pop} = (PX/L)(L/\text{Pop}) = PC_2 p_\ell / C_1 P = C_2 p_\ell / C_1 \quad ,$$

or taking logarithms and rearranging we obtain (17).

$$e_i = c'_{0i} + c_{1i} (p_e - p) + (c_{2i} + c_{3i}) (y - p) \quad (18)$$

where

$$c_{1i} = \psi_{ii} \gamma_i - \beta_i - \delta_i \quad ,$$

$$c_{2i} + c_{3i} = \mu_i + (\psi_{ii} + 1) \beta_i \quad .$$

This is the simplest form of the relation. It shows that in the energy demand function the price elasticity is determined not only by the elasticity of demand for the final good, but also by the production elasticities for the inputs. In particular, the own price elasticity for energy has three terms and combines four parameters: the price elasticity for the final product (ψ_{ii}), the production elasticity of energy inputs (γ_i), and the production elasticities of the other inputs (β_i, δ_i). Note also that the time variable drops out of the demand equation. It is fundamental to note that the specification used here (as in most other demand studies) cannot separate (or identify) the demand term from the parameters of the production function. This problem implies that considerable difficulty will arise in simply applying demand theory to energy demand, and that the coefficients may be quite different from "true" demand parameters. On the other hand it may not be particularly important to know the exact elasticities since for policy and prediction only the response function is necessary.

Further, note that under the usual restrictions on the signs of parameters, the own price term should have a negative coefficient since all three terms are negative. On the other hand the income term is ambiguous since $(\psi_{ii} + 1)$ is indeterminate in sign.

c) It is clear that we will generally be unable to identify all the parameters of the structural equations without outside information. Thus in simplified equation (18), there are two coefficients to be estimated (aside from the constant) and four independent coefficients.

d) The equations as described above do not necessarily meet the budget constraints which are necessary to any set of demand equations. The first set of constraints is that the sum of the price and income coefficients in (15), (16) or (18) be identically zero in all equations. We have ensured this simply by dividing the prices by the price of output, P .

A more difficult set of conditions to satisfy is that the weighted sum of the expenditure elasticities must sum to zero. As has been shown by Koopmans and Uzawa,¹¹ this is not in general possible with constant elasticity demand functions of the type used here. On the other hand, if we reintroduce the omitted second order terms, these conditions can be met, at least locally. In forecasting work, where it is necessary to move beyond small variations, the best solution seems to assume that the biggest sector is the residual sector and thereby make the biggest sector the one that ensures that the accounting identities hold.

e) The fundamental problem of identifying the demand curve can be treated relatively easily. We introduce stochastic terms in equations (2), (7), and (8) as follows:

$$\tilde{h} = h + u \quad (2a)$$

$$\tilde{g} = g + v \quad (7a)$$

$$\tilde{\theta} = \theta + w \quad (8a)$$

where u , v and w are disturbances and the tildes (\sim) indicate that the specification includes the original equation plus the stochastic disturbance. With some tedious manipulation it can be shown that our final equation in (15) can be written as

$$\tilde{e} = e + z \quad (15a)$$

¹¹See Koopmans [39], Uzawa [68].

where

$$\underline{z} = [\underline{\beta} + \underline{\gamma} + \underline{\delta}]^{-1} \left[\underline{w} + \underline{\psi} \{ \underline{v} - [\underline{I} - \underline{\alpha}]^{-1} \underline{u} \} - [\underline{I} - \underline{\alpha}]^{-1} \underline{u} \right] .$$

Since the disturbance is independent of all righthand side variables, the estimates in the equation given above will be consistent.

The further question in identification concerns the independent variables in equation (15).¹² We assume that all variables are independent of the disturbances in the equation. This seems reasonable except for the price of energy, p_e , which is likely to be correlated with disturbances in the energy demand equations. For example, it is sometimes argued that the price escalation in 1973 was largely due to a very rapid growth in energy demand. We think it unlikely that a very serious bias arise for two reasons: First, energy prices are mainly determined in the world market, so that the correlation with the disturbances in individual countries is probably quite small. Second, in some sectors (especially transportation) prices are largely determined by taxes, which are theoretically exogenous and in fact unlikely to be correlated with disturbances.¹³

III. The Data and Variables

The econometric results presented below are for a group of seven western countries: Belgium, France, the Federal Republic of Germany, Italy, the Netherlands, the United Kingdom, and the United States. These countries were chosen in the first round of experiments partially because the author is vaguely familiar with their economies, partially because the

¹²For a discussion of the identification problem in demand analysis, see Malinvaud [45], chapter 18.

¹³See Krugman [41].

assumptions made in the theoretical model are probably best realized in these economies, and perhaps most important because the rather trying data requirements were satisfied.

The time period for the study was basically from 1955 to 1972, for this is the period during which the quantity data collected by the OECD were available. The major difficulty was to gather data on prices of different fuels at the appropriate sectoral level; for this we relied on a combination of statistics published by the European Economic Community, national governments, and guesswork. The data are still in a preliminary state of collection, under the care of Mrs. Claire Doblin, and will be made available when they have been checked and collated in a convenient manner.

In what follows we consider the total consumption of fuel in each sector and ignore the composition (or breakdown) of the total consumption between fuels. The important difference between this and earlier studies is that we consider the demand for net energy, whereas earlier studies considered only gross energy. This distinction rests on the following fundamental hypothesis:

Within each sector, there is a subclass of fuels which are perfect substitutes. For equal levels of non-fuel cost, interfuel competition will be determined by the relative net prices of fuels.

To make this definition operational we need to know the efficiency of each fuel in each sector, denoted by η_{ij} . We then calculate the net consumption (QN_{ij}) and price per unit net energy (PN_{ij}), given gross consumption (Q_{ij}) as:

$$QN_{ij} = \eta_{ij}Q_{ij} \quad ,$$

$$PN_{ij} = P_{ij}/\eta_{ij} \quad .$$

Under the fundamental hypothesis given above, we can write the sectoral aggregate net quantity as a function of sectoral net

price:

$$QN_j = f(\bar{P}_j) \quad , \quad j = \text{sectors}$$

where

$$QN_j = \sum_i QN_{ij} = \sum_i Q_{ij} \eta_{ij}$$

and

$$\bar{P}_j = \sum_i w_{ij} P_{ij}$$

where the weights are the shares in the total net consumption:

$$w_{ij} = QN_{ij} / \sum_i QN_{ij}$$

and

$$\sum_i w_{ij} = 1 \quad .$$

The efficiency data are not generally available and were determined by the author in conjunction with published data (see Hottel and Howard [31]), engineering handbooks, and with the kind help of Mr. Norbert Weyss, now at IIASA, formerly of Brown Boveri. The assumed efficiencies are shown in Table 1. Table 2 shows the tableau of sectors and fuels.

In the aggregate analysis and for the energy sector we do not have data on the energy sector explicitly, so we have used the same price and efficiency data as for the industry sector. It should be stressed that the important aspect of the efficiency figures is the relative size of the efficiencies, and that the absolute levels are completely irrelevant for the estimates. The energy flows can be described in terms of the following tableau in Table 2 where Q_{ij} is quantity and P_{ij} the price of fuel i consumed in sector j in terms of natural units.

Table 1. Efficiencies of different fuels.

| <u>Fuel</u> | <u>S e c t o r</u> | | |
|-------------|--------------------|------------------|------------------------------------|
| | <u>Domestic</u> | <u>Transport</u> | <u>Industry, except energy</u> |
| Solid | 0.20 | 0.044 | 0.70 |
| Liquid | 0.60 | 0.22 | 0.80 |
| Gas | 0.70 | 0.22 | 0.85 |
| Electric | 0.95 | 0.40 | 0.99 |

Macroeconomic Data

Gross Domestic (or National) Product was taken to be the aggregate income measure, and the aggregate price index is the GNP or GDP deflator. Per capita variables refer to total population. Weather variables record the deviation from "climatic means" in degrees centigrade at selected stations for the entire year.

Pooling of Country Data

In the pooling of individual countries, it is assumed that countries have the same preference functions and production functions; since the rate and level of technological change

Table 2. Tableau of sectors and fuels.

| Fuel | Sector | | | | |
|---|----------------------|-------------------------|--|---|------------------|
| | <u>Energy</u> (N) | <u>Transport</u> (T) | <u>Industry</u> (except energy) (I) | <u>Residential Commercial and Residual</u> (D) | <u>Aggregate</u> |
| Liquid (petroleum) | Q_{LN}, P_{LN} | Q_{LT}, P_{LT} | ... | ... | Q_{LA}, P_{LA} |
| Gas (Town Gas, Natural Gas) | Q_{GN}, P_{GN} | | | | ⋮ |
| Solid (Coal, Lignite, Briquettes) | Q_{SN}, P_{SN} | | | | |
| Electricity | Q_{EN}, P_{EN} | ... | | ... | Q_{EA}, P_{EA} |

drop out of the equation, there is no need to assume these to be the same across countries. The major difficulty in pooling countries revolves around the question of the appropriate conversions between different currencies.

The usual procedure is to use market exchange rates, but these are seriously deficient. First, it is clear that for market economies market exchange rates reflect in part volatile temporary factors, and that temporary movements do not reflect genuine changes in the relative real incomes of different countries. Is it credible that from January 1973 to February 1973 the relative real income of the USA fell 120 percent at an annual rate? This point is even clearer for countries with non-market determined (or official) exchange rates, where these are instruments of policy. A superior method of measuring real incomes is to use purchasing power parity rates, which compare the purchasing power of incomes of different countries. Since these indices will differ according to the bundle of goods used, we have taken the geometric mean of purchasing power exchange rates according to the USA and the local composition of GNP with 1960 as a base year. These are used to translate each currency into a "universal" standard of value for a given year; domestic GNP deflators are then used to indicate changes over time. It should be noted that purchasing power parity exchange rates generally lead to a lower inequality of income distribution across countries than existing exchange rates.¹⁴

The Lag Structure

From either a theoretical or a casual viewpoint, it is clear that the time lags in the response function are likely

¹⁴This procedure is discussed by Balassa [7]. The purchasing power parities used in the present paper are drawn from Balassa.

to be quite long; it would be surprising if full adjustment in the lag took place in less than ten years. Because the sample period for an individual country is short (no more than eighteen years), it is extremely difficult to get a precise determination of the lag structure. On the other hand, if we are mainly concerned with the long-run price and income elasticities, our specifications will be directed toward getting firm estimates of the long-run elasticities and less toward a precise determination of the lag.

In the present paper we will use two different lag structures: first, the Koyck or geometric lag:¹⁵

$$y_t = (1-\lambda)y_{t-1} + \lambda y^*(z)$$

where

- y_t is the realized value of the dependent variable;
- y_{t-1} the realized value lagged once; and
- y^* the desired or long-run level of the dependent variable which in turn is a function of exogenous variables z .

The Koyck lag has the advantage of being extremely parsimonious in the use of variables; this advantage must be weighed against the disadvantages that the lag structure imposed on all variables is the same and is geometric declining, and the more important statistical disadvantage that if the errors are autocorrelated the estimate of the coefficient λ is biased.

As a second form of lag structure, we have also used the polynomial or Almon lag:

¹⁵See Koyck [40] and Malinvaud [45], Chapter 15.

$$y_t = \alpha + \sum_{i=0}^T \beta_i z_{t-i} .$$

In this specification the β_i are assumed to be of degree $n \leq T$, where $\beta_i = \sum_{\theta=0}^n \gamma(\theta) i^\theta$ for $0 \leq \theta \leq T$ and $\beta_i = 0$ otherwise. For forms where there are no end restrictions, this procedure involves estimating $(n + 1)$ rather than $(T + 1)$ coefficients.¹⁶ The length of lag is predetermined, as is the degree of the polynomial. This technique has the advantages that it leads to an unbiased estimate of the coefficients as well as that it allows a flexible shape of the lag; the important disadvantage, however, is that the length of the sample will be very seriously reduced if either the sample period is short or if length of lag is long.

It is clear from this very short description that in a rough sense the geometrical and the polynomial lags complement each other. If their messages are strong and similar, then we can have some confidence in the results. If the messages are weak or dissimilar, then we must be suspicious of both.

IV. Results: Individual Countries¹⁷

The model described above was applied to both individual countries and to all seven countries pooled. We will first present the results for the unpooled data. The specifications examined in the tables below are:

$$q_t = a_0 + a_1 p_t + a_2 y_t + a_3 q_{t-1} \quad (A)$$

$$q_t = b_0 + b_1 \left(\sum_{i=0}^{T-1} w_i p_{t-i} \right) + b_2 y_t , \quad \sum w_i = 1 . \quad (B)$$

¹⁶ See Almon [4] or Dhrymes [20].

¹⁷ The results for Belgium were not completed on time for the individual country results, although Belgium is included in the pooled equations.

where

(B1) has $T_0 = 0$, $T_1 = 3$, w_i quadratic with $w_4 = 0$;

(B2) has $T_0 = 0$, $T_1 = 5$, w_i quadratic with $w_6 = 0$;

and

q_t = per capita net energy consumption;

p_t = relative net price of energy; and

y_t = per capita real GNP;

all variables in natural logarithms.

Results for the Aggregate

First consider the aggregate equations for the economies. These aggregate four sectors: energy, transportation, industry other than energy, and residential-residual.

Tables 3 and 4 present the results in a standard format that will be used for the individual sectors as well. In this we present only the elasticities and not the overall statistics of the equations. The elasticities in the column "short-run" are defined as:

$$\text{short-run elasticity} = \frac{\text{percentage change in net energy demanded during current year}}{\text{percentage change in net energy price during current year}}$$

while the long-run elasticity is defined as:

$$\text{long-run elasticity} = \frac{\text{percentage change in net energy demanded per year after entire lag is included}}{\text{percentage change in net energy price during current year}}$$

In terms of formulas (A) and (B) above, the short-run elasticity is a_1 or a_2 in equation (A), and $b_1 w_0$ or b_2 in

Table 3. Income elasticities for different countries and different specifications: aggregate.

| | Short-run | | | Long-run | | |
|--------------------------------|---------------|----|----|-----------------|---------------|---------------|
| | A | B1 | B2 | A ^{b)} | B1 | B2 |
| France | 1.11 (.26) | a) | a) | c) | 1.17 (.09) | 1.20 (.18) |
| Federal Republic of Germany | .29 (.11) | a) | a) | .61 (.31) | 1.15 (.13) | 1.42 (.11) |
| Italy | 1.07 (.37) | a) | a) | 1.55 (.67) | 1.25 (.13) | 1.16 (.26) |
| Netherlands | .57 (.28) | a) | a) | .78 (.46) | .48 (.34) | .05 (.50) |
| United Kingdom | .57 (.13) | a) | a) | .66 (.22) | .67 (.09) | .60 (.18) |
| United States | .39 (.10) | a) | a) | .84 (.32) | .32 (.10) | .26 (.09) |

Note: Figures without parentheses are coefficients, while figures in parentheses are standard errors.

a) Short-run elasticity assumed equal to long-run.

b) Calculation of local standard error given in Appendix.

c) Lag term had incorrect sign, so long-term elasticity not calculated.

Table 4. Price elasticities for different countries and different specifications: aggregate.

| | Short-run | | | Long-run | | |
|--------------------------------|---------------|---------------|---------------|-----------------|----------------|----------------|
| | A | B1 | B2 | A ^{b)} | B1 | B2 |
| France | -.16 (.12) | -.03 (.09) | -.08 (.10) | c) | .10 (.26) | .06 (.15) |
| Federal Republic of Germany | -.44 (.25) | .30 (.19) | .17 (.13) | -.89 (.59) | .70 (.32) | 1.45 (.47) |
| Italy | -.33 (.24) | -.72 (.13) | -.75 (.11) | -.50 (.39) | -1.30 (.21) | -1.33 (.45) |
| Netherlands | -.58 (.21) | -.68 (.19) | -.56 (.23) | -.81 (.39) | -1.20 (.25) | -1.56 (.51) |
| United Kingdom | -.42 (.16) | -.42 (.14) | -.35 (.16) | -.49 (.22) | -.26 (.25) | -.31 (.28) |
| United States | -.26 (.28) | -.50 (.19) | -.41 (.16) | -.57 (.64) | -1.73 (.36) | 1.94 (.34) |

Note: Figures without parentheses are coefficients, while figures in parentheses are standard errors.

-
- a) Short-run elasticity assumed equal to long-run.
b) Calculation of local standard error given in Appendix.
c) Lag term had incorrect sign, so long-term elasticity not calculated.

equation (B). The long-run elasticity is $a_1/(1 - a_3)$ or $a_2/(1 - a_3)$ in equation (A) and b_1 or b_2 in equation (B).

First consider the income elasticities reported in Table 3: We focus only on the long-run elasticities. These show one major surprise: the elasticities appear to differ significantly across different countries. The US, UK, and Netherlands have low elasticities, while the other three countries have rather high elasticities. There is no clear indication as to whether energy demand tends to grow faster or slower than output. Moreover, these results are quite significant by the standard statistical tests.

The price elasticities for the aggregate economies are reported in Table 4. These results are in fact quite representative of the general quality of the estimates for price elasticities: they are highly variable and not well determined. Again examine specification (B1). Italy, Netherlands, and the United States have well-determined price terms, with the correct sign. France and the FRG have incorrect signs, but they are poorly determined.

It is possible to calculate a composite statistic for the sample countries: this relies on the assumption that the coefficients are samples from distributions with a common mean (\bar{M}) and differing variance--the variance differing because the range of the independent variables differs. These statistics are shown in Table 5 for specification (B1) (this specification was chosen to maximize sample size and minimize the standard error of the coefficients.)¹⁸

The results for the composite statistics give somewhat greater shape to the verbal discussion of the results for the aggregate. They indicate that demand is price-inelastic, and moderately well-determined. The income elasticity, on the other hand, is quite well determined in the aggregate, and is slightly, but not significantly less than +1.

¹⁸The derivation of the composite statistic is given in the Appendix.

Table 5. Composite estimate of coefficients, specification B1: aggregate.

| | Mean | Standard Deviation |
|-------------------|-------|--------------------|
| Price elasticity | -0.66 | 0.26 |
| Income elasticity | 0.84 | 0.11 |

Note: The composite statistic is calculated by the formula for the minimum variance estimate for a sample from a different population with the same mean and different variances (see Appendix).

Individual Sectors

The national economies were also disaggregated into four sectors, and each sector was analyzed to see if there were significant effects. Each sector, it should be noted, has its individual price and quantity index, but the output indicator for each of the individual sectors is the national output indicator.

In discussing the individual countries and sectors, we will use the following criterion in determining which specification is preferred: roughly speaking, we choose the specification which has the lowest standard error for the coefficient. On the other hand, we realize that the standard errors in specification (A) are probably biased downward because of the inclusion of the lagged dependent variable, and make a rough correction by multiplying this standard error by 1.5 in making the comparisons. For most cases, this makes the specification (B1) the preferred specification; this specification is used in all composite statistics.¹⁹

The domestic sector is shown in Tables 6 and 7. These results are quite encouraging, indeed the most encouraging of any sector. The income elasticities are positive, presumably indicating that higher levels of income are important in inducing both central heating and the use of many energy-intensive appliances. On the other hand, the income elasticities show some irregularity across the sample.

As far as the price elasticities are concerned, these are consistently negative across both countries and specifications. The only positive coefficients are for France, but these are not significant. The FRG, Italy, the Netherlands and the United States show consistent, significant and negative price elasticities,

¹⁹This is in distinction to the usual procedure of choosing a specification with a high t-statistic. Put differently, we are interested in precise determination of the results, not in whether the results show a significant difference from an arbitrary number.

Table 6. Income elasticities for different countries and different specifications: domestic.

| | Short-run | | | Long-run | | |
|--------------------------------|--------------|----|----|-----------------|---------------|---------------|
| | A | B1 | B2 | A ^{b)} | B1 | B2 |
| France | .93 (.55) | a) | a) | 1.86 (1.54) | 2.34 (.52) | 3.43 (.94) |
| Federal Republic of Germany | .60 (.29) | a) | a) | 1.30 (.71) | 1.55 (.28) | 1.77 (.40) |
| Italy | .65 (.27) | a) | a) | 1.10 (.51) | .49 (.29) | .43 (.37) |
| Netherlands | .21 (.52) | a) | a) | .42 (1.05) | .00 (.63) | -.11 (.95) |
| United Kingdom | .97 (.36) | a) | a) | 1.04 (.55) | 1.10 (.32) | .57 (.52) |
| United States | .17 (.12) | a) | a) | .47 (.36) | .27 (.08) | .22 (.09) |

Note: Figures without parentheses are coefficients, while figures in parentheses are standard errors.

a) Short-run elasticity assumed equal to long-run.

b) Calculation of local standard error given in Appendix.

c) Lag term had incorrect sign, so long-term elasticity not calculated.

Table 7. Price elasticities for different countries and different specifications: domestic.

| | Short-run | | | Long-run | | |
|--------------------------------|---------------|---------------|---------------|-----------------|----------------|----------------|
| | A | B1 | B2 | A ^{b)} | B1 | B2 |
| France | -.07 (.29) | .02 (.27) | .33 (.28) | -.14 (.59) | .22 (.34) | 1.24 (.83) |
| Federal Republic of Germany | -.35 (.19) | -.35 (.18) | -.34 (.21) | -.76 (.46) | -.68 (.35) | -.49 (.25) |
| Italy | -.63 (.13) | -.65 (.15) | -.62 (.19) | -1.05 (.30) | -1.40 (.25) | -1.44 (.36) |
| Netherlands | -.58 (.21) | -.42 (.20) | -.35 (.28) | -1.16 (.58) | -1.30 (.33) | -1.37 (.55) |
| United Kingdom | -.36 (.19) | -.40 (.37) | -.38 (.40) | -.38 (.25) | -.30 (.45) | -.59 (.48) |
| United States | -.55 (.19) | .52 (.12) | -.57 (.10) | -1.53 (.71) | -1.75 (.21) | -1.90 (.20) |

Note: Figures without parentheses are coefficients, while figures in parentheses are standard errors.

a) Short-run elasticity assumed equal to long-run.

b) Calculation of local standard error given in Appendix.

c) Lag term had incorrect sign, so long-term elasticity not calculated.

while the United Kingdom is negative but only marginally significant.

We have again calculated the composite statistics in Table 8. These statistics indicate that if we treat the results as a random sample from a population with fixed mean and different variances then the price coefficient is quite well-determined, -1.14 with a standard error of 0.29 , while the income elasticity is quite low and very well-determined, 0.44 ($\pm .17$).

For the transport sector, the results are quite mixed. Recall that the transport sector is largely road transport (approximately 80% of fuel is for automobiles, trucks, and buses). Further it is generally thought that transport is highly income elastic. The results of Table 9 bear this out by and large. All six countries show that transport has an income elasticity greater than unity; for high income countries (the US and FRG) the income elasticities are very close to unity, while the medium and low income countries (especially Italy and the UK) have income elasticities which are very high.

The price elasticities for the transport sector are also quite encouraging (see Table 10). We originally hoped that the wide range of prices, mainly due to taxation on fuel for road traffic, would lead to well-determined price coefficients. The major anomaly is that short-run price elasticities are too large, although they are not particularly well determined. The coefficients for the short-run--or one year--price elasticities lie in the range from $.02$ to $-.65$. These results indicate that it would not be surprising to find a rapid response of consumption in the transport sector to the very rapid rise in fuel costs over the last few years. Surprisingly, long-run coefficients hardly differ from the short-run coefficients. The long-run coefficients range from $.13$ to $-.87$. Three countries have quite sharply determined long-run coefficients: France ($-.15 \pm .13$), the FRG ($-.87 \pm .18$), and the UK ($-.15 \pm .21$). The overall impression is that transport

Table 8. Composite for the domestic sector, specification (B1).

| | Mean | Standard deviation |
|-------------------|-------|--------------------|
| Price elasticity | -1.14 | .29 |
| Income elasticity | 0.44 | .17 |

Note: The composite statistic is calculated by the formula for the minimum variance estimate for a sample from a different population with the same mean and different variance (see Appendix).

Table 9. Income elasticities for different countries and different specifications: transport.

| | Short-run | | | Long-run | | |
|--------------------------------|---------------|----|----|-----------------|---------------|---------------|
| | A | B1 | B2 | A ^{b)} | B1 | B2 |
| France | 1.62 (.42) | a) | a) | c) | 1.32 (.08) | 1.34 (.15) |
| Federal Republic of Germany | .79 (.18) | a) | a) | 1.65 (.56) | 1.19 (.11) | 1.06 (.16) |
| Italy | .61 (.21) | a) | a) | 1.53 (.67) | 1.65 (.14) | 1.63 (.26) |
| Netherlands | .33 (.13) | a) | a) | 1.74 (.94) | 1.52 (.20) | 1.18 (.24) |
| United Kingdom | 1.54 (.50) | a) | a) | 2.20 (1.05) | 2.11 (.06) | 2.09 (.08) |
| United States | .24 (.09) | a) | a) | .83 (.49) | 1.01 (.15) | 1.68 (.42) |

Note: Figures without parentheses are coefficients, while figures in parentheses are standard errors.

a) Short-run elasticity assumed equal to long-run.

b) Calculation of local standard error given in Appendix.

c) Lag term outside a priori range, so long-term elasticity not calculated.

Table 10. Price elasticities for different countries and different specifications: transport.

| | Short-run | | | Long-run | | |
|--------------------------------|---------------|----------------|---------------|-----------------|---------------|----------------|
| | A | B1 | B2 | A ^{b)} | B1 | B2 |
| France | -.66 (.25) | -.29 (.09) | -.18 (.08) | c) | -.15 (.13) | -.10 (.16) |
| Federal Republic of Germany | -.13 (.14) | -.55 (.09) | -.53 (.07) | -.28 (.31) | -.87 (.18) | -.89 (.19) |
| Italy | -.09 (.07) | -.24 (.26) | -.17 (.43) | -.23 (.19) | -.60 (.40) | .01 (.65) |
| Netherlands | .05 (.10) | -.49 (.23) | -.38 (.14) | .26 (.53) | -.37 (.40) | -.92 (.38) |
| United Kingdom | .02 (.12) | -.20 (.09) | -.17 (.10) | .03 (.12) | -.15 (.21) | -.16 (.20) |
| United States | -.22 (.14) | -1.04 (.20) | -.82 (.20) | -.76 (.59) | .13 (.47) | 1.88 (1.21) |

Note: Figures without parentheses are coefficients, while figures in parentheses are standard errors.

a) Short-run elasticity assumed equal to long-run.

b) Calculation of local standard error given in Appendix.

c) Lag term had incorrect sign, so long-term elasticity not calculated.

demand is quite price-inelastic. The one disturbing feature is that the lag structure is simply implausible: the long-run coefficients in some cases are smaller than the short-run coefficients, and this is unacceptable.

Table 11 shows the composite statistic for the transport sector. As noted above, the overall result is that the income elasticity is larger than unity, and quite significantly so, while the price elasticities are small and negative.

Industry is divided into two parts, the energy and the non-energy sectors. The energy sector, strictly speaking, should not be treated in a symmetrical manner with those sectors in which energy is consumed. Nevertheless for completeness we present both sets of results.

Tables 12 and 13 present the regression results for industry, except the energy sector. The income elasticities again show the general patterns of having net demands with income elasticities scattered around unity, and they are generally pretty well determined. The price elasticities, on the other hand, show a pattern of instability, ranging from 1.0 for the FRG to -1.0 for Italy. Only four coefficients, however, are well determined: Italy, France, and the UK have a significantly negative coefficient, while the FRG has a significant positive coefficient.

The composite results for the industry except the energy sector are shown in Table 14. These show that this sector has an income elasticity below, but not significantly below unity, and a price coefficient which is negative, but again not significantly so.

Finally, we have the results for the energy sector. It should first be noted that this sector has a rather different character from the other sectors. Energy consumption in the energy sector is in reality energy consumed in transformation of one energy form into another, or in extraction and upgrading of fuels. Thus the energy consumption in the energy sector

Table 11. Composite statistic for transport, specification (B1).

| | Mean | Standard deviation |
|-----------|------|--------------------|
| Income | 1.68 | .10 |
| Price | | |
| Short-run | -.39 | .12 |
| Long-run | -.36 | .22 |

Note: The composite statistic is calculated by the formula for the minimum variance estimate for a sample from a different population with the same mean and different variance (see Appendix).

Table 12. Income elasticities for different countries and different specifications: industry, except energy.

| | Short-run | | | Long-run | | |
|--------------------------------|---------------|----|----|-----------------|---------------|----------------|
| | A | B1 | B2 | A ^{b)} | B1 | B2 |
| France | .17 (.25) | a) | a) | .29 (.45) | .57 (.16) | .18 (.26) |
| Federal Republic of Germany | .24 (.17) | a) | a) | .46 (.38) | 1.24 (.17) | 1.38 (.16) |
| Italy | 1.18 (.22) | a) | a) | c) | 1.15 (.19) | 1.72 (.47) |
| Netherlands | .72 (.50) | a) | a) | .87 (.66) | 1.72 (.70) | 2.11 (1.25) |
| United Kingdom | -.02 (.12) | a) | a) | -.02 (.13) | .06 (.15) | -.17 (.25) |
| United States | .63 (.40) | a) | a) | .97 (.42) | .99 (.13) | .92 (.19) |

Note: Figures without parentheses are coefficients, while figures in parentheses are standard errors.

a) Short-run elasticity assumed equal to long-run.

b) Calculation of local standard error given in Appendix.

c) Lag term had incorrect sign, so long-term elasticity not calculated.

Table 13. Price elasticities for different countries and different specifications: industry, except energy.

| | Short-run | | | Long-run | | |
|--------------------------------|---------------|---------------|---------------|-----------------|---------------|---------------|
| | A | B1 | B2 | A ^{b)} | B1 | B2 |
| France | -.47 (.13) | -.45 (.10) | -.39 (.08) | -.82 (.46) | -.38 (.16) | -.44 (.20) |
| Federal Republic of Germany | -.11 (.29) | .29 (.15) | .04 (.13) | -.21 (.56) | 1.03 (.25) | 1.06 (.28) |
| Italy | -.82 (.17) | -.60 (.14) | -.49 (.13) | c) | -.96 (.22) | .45 (.41) |
| Netherlands | -.51 (.27) | -.34 (.28) | -.29 (.37) | -.61 (.37) | .01 (.48) | .28 (.83) |
| United Kingdom | -.79 (.20) | -.79 (.17) | -.63 (.23) | -.88 (.28) | -.73 (.31) | -.95 (.43) |
| United States | -.21 (.40) | -.09 (.18) | -.11 (.17) | -.33 (.63) | -.35 (.23) | -.47 (.26) |

Note: Figures without parentheses are coefficients, while figures in parentheses are standard errors.

a) Short-run elasticity assumed equal to long-run.

b) Calculation of local standard error given in Appendix.

c) Lag term had incorrect sign, so long-term elasticity not calculated.

Table 14. Composite statistics for industry, except energy, specification (B₁).

| | Mean | Standard deviation |
|--------|-------|--------------------|
| Income | 0.78 | 0.17 |
| Price | -0.30 | 0.23 |

Note: The composite statistic is calculated by the formula for the minimum variance estimate for a sample from a different population with the same mean and different variance (see Appendix).

will be relatively large if the country has a large extractive industry, as in the FRG or the United States; or if the mix of fuels is tilted toward converted fuels (such as electricity or town gas) rather than low grade fuels (such as coal); or if the energy sector has low conversion efficiencies in transformation processes such as electricity generation. Thus in judging the energy-intensiveness of economies, especially where considerable specialization occurs, one should probably exclude the energy sector and consider only the rest of the economy.

Notwithstanding these caveats, we present in Tables 15 and 16 the results for the energy sector. One surprising result is that the energy sector exhibits very low income elasticities, ranging from a low of $-.94$ for the United Kingdom to a high of $.36$ for the United States. The price elasticities are again quite mixed: Italy and France show negative significant coefficients, while all other countries show insignificant coefficients.

Table 17 shows the composite statistics for the energy sector: these confirm the impression that the income elasticity tends to be somewhat low and the price coefficient is negative but insignificant.

V. Results for the Pooled Sample

The results presented above for the individual countries are not entirely encouraging; an honest man would have to admit that they shed little light on the questions that the present study set out to investigate. However, it was originally hoped that by combining the experience of the several countries in the sample the results could be sharpened. Thus the next step considers combining or pooling the data into a single relationship.

The theoretical basis for pooling countries is to assume that all countries have similar preference functions and production functions, but that the differences in incomes and

Table 15. Income elasticities for different countries and different specifications: energy.

| | Short-run | | | Long-run | | |
|--------------------------------|---------------|----|----|-----------------|---------------|-----------------|
| | A | B1 | B2 | A ^{b)} | B1 | B2 |
| France | .34 (.31) | a) | a) | .97 (1.10) | .32 (.19) | .38 (.37) |
| Federal Republic of Germany | -.32 (.16) | a) | a) | -.65 (.45) | -.13 (.27) | .49 (.24) |
| Italy | -.09 (.31) | a) | a) | -.27 (.93) | .25 (.30) | -.98 (.45) |
| Netherlands | .28 (.43) | a) | a) | c) | -.01 (.89) | -1.04 (1.69) |
| United Kingdom | -.41 (.24) | a) | a) | -.75 (.66) | -.94 (.17) | -1.28 (.29) |
| United States | .27 (.10) | a) | a) | .45 (.22) | .36 (.07) | .28 (.08) |

Note: Figures without parentheses are coefficients, while figures in parentheses are standard errors.

a) Short-run elasticity assumed equal to long-run.

b) Calculation of local standard error given in Appendix.

c) Lag term had incorrect sign, so long-term elasticity not calculated.

Table 16. Price elasticities for different countries and different specifications: energy.

| | Short-run | | | Long-run | | |
|--------------------------------|---------------|---------------|---------------|-----------------|----------------|----------------|
| | A | B1 | B2 | A ^{b)} | B1 | B2 |
| France | .08 (.22) | .52 (.10) | .22 (.10) | .23 (.66) | -.30 (.12) | -.48 (.23) |
| Federal Republic of Germany | -.28 (.26) | -.06 (.32) | -.25 (.23) | -.56 (.59) | .89 (.50) | 2.15 (.43) |
| Italy | -.48 (.20) | -.49 (.18) | -.55 .27 | -1.45 (1.17) | -1.19 (.35) | -2.41 (.72) |
| Netherlands | -.39 .24 | -.32 (.24) | -.21 (.25) | c) | -.52 (.49) | -1.11 (.88) |
| United Kingdom | .01 (.30) | .11 (.25) | .04 (.23) | .02 (.67) | 1.28 (.73) | 2.14 (1.34) |
| United States | -.22 (.15) | -.18 (.14) | -.26 (.13) | -.37 (.28) | -.71 (.44) | -1.53 (.67) |

Note: Figures without parentheses are coefficients, while figures in parentheses are standard errors.

a) Short-run elasticity assumed equal to long-run.

b) Calculation of local standard error given in Appendix.

c) Lag term had incorrect sign, so long-term elasticity not calculated.

Table 17. Composite statistics for energy.

| | Mean | Standard deviation |
|--------|-------|--------------------|
| Income | 0.18 | 0.14 |
| Price | -0.33 | 0.25 |

Note: The composite statistic is calculated by the formula for the minimum variance estimate for a sample from a different population with the same mean and different variances (see Appendix).

relative prices lead to different energy-intensiveness in different sectors. Thus we would expect that with high gasoline prices and low incomes in Europe, the amount of gasoline consumed in Europe per person would be considerably below that in North America, which has low relative gasoline prices and high relative incomes. In addition to the systematic effects of prices and incomes, there may be other omitted variables which are crucial to the determination of energy demand. Thus weather is clearly important in determining domestic heating demands; the road network in determining automotive demand; the industrial structure in determining the industrial demand. We have assumed that these effects, which can be called country effects, are multiplicative and do not vary systematically over time. This implies that we can simply use country dummy variables in our logarithmic specification to represent the effects for individual countries. We would be surprised if these country effects were nil; on the other hand, we would be disappointed if they accounted for too much of the variation.

Thus the specification for the pooled model is that countries have different levels of energy demand, but that the elasticities, or response to prices and incomes, are constrained to be the same. In order to prepare for what follows, it should be noted how the pooling is able to reduce the chaos of the individual country results to relatively well-determined answers. Recall that the individual country results are poorly determined; this is largely due to the fact that price and income are highly collinear for an individual country, and therefore the data cannot determine the coefficients with great precision. This problem, the problem of multicollinearity, is shown graphically in Figure 1. Country A has a history of incomes and prices which determines a likelihood function for coefficients b_1 and b_2 shown by the contours lying between A and A'; the contours indicate a given confidence region for the country. For country A the individual coefficients are poorly determined and lie along a "ridge." Country B has a

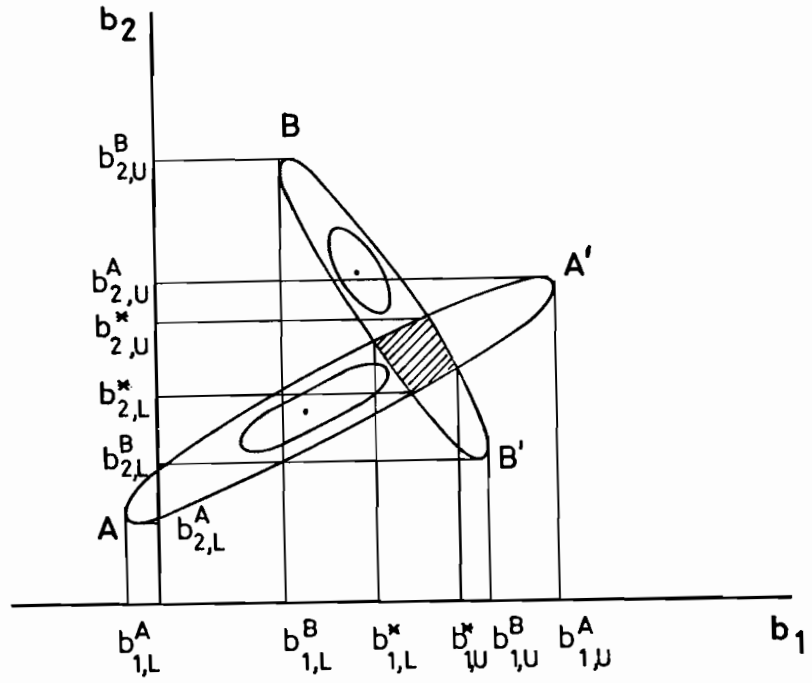

Figure 1. Shaded area represents the estimate of (b_1, b_2) obtained by pooling two samples with multicollinear data.

rather different history, but one which also exhibits high multicollinearity between the two independent variables, with a resulting likelihood function shown by the BB' contours, which lie along a different "ridge."

Consider what happens when countries A and B are pooled and constrained to have the same elasticities: only the shaded region in Figure 1 lies above the second set of likelihood contours for both countries. Thus the joint region, consistent with the histories of both countries lies in a much smaller region than that for either of the individual countries. Thus if the outer contour represents the 90% contour level, we have rather wide ranges of estimates for the parameters, with the confidence interval for b_1 lying in the range $[b_{1,L}^A, b_{1,U}^A]$ for country A and in the range $[b_{1,L}^B, b_{1,U}^B]$ for country B, with the analogous range for the coefficient b_2 . By pooling the two countries, the confidence interval which is consistent with both histories is reduced to the much smaller range $[b_{1,L}^*, b_{1,U}^*]$ for b_1 and the analogous range for b_2 .²⁰ Put differently, if the individual histories show great multicollinearity (which they do in the energy area), and if the different countries have rather different histories (which, again, they do), then it is possible to break the grip of the multicollinearity by pooling the countries. Note that it is not necessary that the outcome be so nice as that pictured in Figure 1; it could turn out that a third country lay well outside the shaded region and the coefficients would remain very poorly determined. With seven countries, it seems likely that the results will reduce the uncertainty due to the multicollinearity without lending spurious accuracy to the results.

²⁰It should be noted that the shaded region is only a heuristic device for indicating the results of pooling. It is slightly more complicated to determine the exact likelihood contours for the joint sample of A and B.

In our pooling we have used a sample period which is common for all sectors and which is as follows:

| | | |
|---|-------|-------------------|
| United States (1959-1972) | 14 | observations |
| Federal Republic of Germany (1960-1972) | 13 | |
| France (1959-1972) | 14 | |
| Italy (1964-1972) | 9 | |
| Belgium (1965-1972) | 8 | |
| Netherlands (1959-1972) | 14 | |
| United Kingdom (1963-1972) | 10 | |
| Total | <hr/> | 82 observations . |

We kept the length of lag relatively short--a maximum of one year lag for income and four years for price. We could have extended the lag for price, but as each further year reduced the number of observations by seven, four years seemed a good compromise. Moreover, although we were interested in the lag structure, the major purpose of the study was the long-run income and price elasticities, so an attempt was made to estimate these in as sharp a way as possible.

To construct the equations we made the following simplifications. First, the current and lagged income terms appeared to have the same sized coefficients, so we constrained them to be equal. Next, we assumed that the lag on prices was linear over a five year period; this lag is undoubtedly too short, but the shape is probably roughly correct. With these assumptions we reduce the equations to the following:

$$q_{ti} = \alpha_i + \beta \left[\sum_{\theta=0}^4 0.2 P_{t-\theta,i} \right] + \gamma [0.5y_{t,i} + 0.5y_{t-1,i}]$$

(19)

where

α_i are individual country effects;

β is the common long-run price elasticity; and

γ the common long-run income elasticity.

The results for the four individual sectors and the aggregate are shown in Tables 18-22. In what follows we focus on the long-run price elasticities and the differences between individual countries. Note that because the dummy variable for the United States is omitted, country variables should be interpreted as different from the United States.²¹

Results

The results of the pooling show a considerable improvement over the unpooled data. In all of the four demand sectors the price elasticities have the right sign and are well-determined while all the income elasticities are very well-determined. First concentrating on the price elasticities, it is seen that these are $-.36 (\pm .12)$ for the transport sector, $-.79 (\pm .08)$ for the residential sector, $-.52 (\pm .17)$ for industry other than energy, and $-.58 (\pm .10)$ for the energy sector.²² In the aggregate, the estimate is $-.85 (\pm .10)$. These results are not out of line with results of other studies: for the most part, where price elasticities have been found, these lie in the range from 0 to -1 .²³ Elasticities of this magnitude indicate that the long-run response of energy consumption to price is only moderate when the three factors discussed above are combined; these were the demand response proper, the production response, and the substitution between energy and other factors. To the extent that we can take the differences

²¹A note on the statistics: R^2 is the fraction of the variance of the dependent variable explained by the regression, whereas \bar{R}^2 is corrected for degrees of freedom. SEE is the standard error of estimate of the equation. Since the equation is in logarithmic terms the SEE is roughly the fractional error (or $100 \times$ SEE roughly the average percentage error). D.W. is the Durbin-Watson Statistic, while corrected D.W. is adjusted for jumps in the data (see Appendix).

²²The text gives the estimated coefficients plus-or-minus the estimated standard error of the coefficient.

²³See [5, 8, 12, 14, 25, 27, 32, 44, 61].

Table 18. Results for pooled sample, aggregate.

| | | | |
|---|--------------------------------------|---|--------------------|
| q_t = 4.700 (0.170) [27,800] | $-$ 0,850 (0.100) [8.800] | $\left[\begin{array}{l} 4 \\ \Sigma \\ \theta=0 \end{array} \right]$ | $0.2 p_{t-\theta}$ |
| | $+$ 0.790 (0.080) [10.000] | $\left[\begin{array}{l} 1 \\ \Sigma \\ \theta=0 \end{array} \right]$ | $0.5 y_{t-\theta}$ |
| D(UK) = 0.030 (0.030) [0.800] | D(GE) = -0.090 (0.030) [3.500] | D(BE) = 0.130 (0.140) [1.000] | |
| D(NE) = -0.250 (0.030) [8.500] | D(FR) = -0.350 (0.040) [9.100] | D(IT) = -0.350 (0.040) [9.300] | |
| R^2 = 0.989 | | D.W. = 0.840 | |
| \bar{R}^2 = 0.988 | | corrected D.W. = 0.740 | |
| SEE = 0.049 | | observations = 82.000 | |

where

q_t = log (per capita net energy consumption);

p_t = log (price of net energy/GDP deflator);

y_t = log (real per capita GDP);

D = dummy variable for countries, where UK = United Kingdom, GE = FRG, BE = Belgium, NE = Netherlands, FR = France, IT = Italy;

and

top figures are estimated coefficients;

figures in parentheses are standard errors of coefficients;

figures in brackets are t-statistics.

Table 19. Results for pooled sample, domestic.

| | | | | | | |
|-----------------------------------|--------------------------------|---|---|--|---|--|
| q_t $=$ $=$ $[16.000]$ | $=$ (0.200) $[16.000]$ | $-$ 0.790 (0.080) $[10.300]$ | $\left[\begin{array}{l} 4 \\ \Sigma \\ \theta=0 \end{array} \right]$ $0.2 p_{t-\theta}$ | $+$ 1.080 (0.120) $[8.800]$ | $\left[\begin{array}{l} 1 \\ \Sigma \\ \theta=0 \end{array} \right]$ $0.5 y_{t-\theta}$ | |
| D(UK) | = 0.240 (0.030) [6.600] | D(GE) | = -0.050 (0.070) [1.700] | D(BE) | = 0.110 (0.030) [3.200] | |
| D(NE) | = -0.090 (0.050) [1.800] | D(FR) | = -0.390 (0.040) [10.200] | D(IT) | = -0.460 (0.070) [7.000] | |
| R^2 | = 0.991 | | | D.W. | = 1.090 | |
| \bar{R}^2 | = 0.990 | | | corrected D.W. | = 1.010 | |
| SEE | = 0.059 | | | observations | = 82.000 | |

where

q_t = log (per capita net energy consumption);
 p_t = log (price of net energy/GDP deflator);
 y_t = log (real per capita GDP)
D = dummy variable for countries, where UK = United Kingdom, GE = FRG, BE = Belgium, NE = Netherlands, FR = France, IT = Italy;

and

top figures are estimated coefficients;
figures in parentheses are standard errors of coefficients;
figures in brackets are t-statistics.

Table 20. Results for pooled sample, industry, except energy.

| | | | |
|---|--------------------------------------|---|--------------------|
| q_t = 2.980 (0.200) [15.300] | - 0.520 (0.170) [3.100] | $\left[\begin{array}{l} 4 \\ \Sigma \\ \theta=0 \end{array} \right]$ | $0.2 p_{t-\theta}$ |
| | + 0.760 (0.160) [4.700] | $\left[\begin{array}{l} 1 \\ \Sigma \\ \theta=0 \end{array} \right]$ | $0.5 y_{t-\theta}$ |
| D(UK) = 0.800 (0.050) [1.500] | D(GE) = 0.280 (0.060) [4.600] | D(BE) = 0.190 (0.070) 2.500 | |
| D(NE) = -0.340 (0.050) [6.400] | D(FR) = -0.190 (0.050) [3.800] | D(IT) = -0.110 (0.080) [1.400] | |
| R^2 = 0.952 | | D.W. = 0.670 | |
| \bar{R}^2 = 0.947 | | corrected D.W. = 0.560 | |
| SEE = 0.091 | | observations = 82.000 | |

where

q_t = log (per capita net energy consumption);

p_t = log (price of net energy/GDP deflator);

y_t = log (real per capita GDP);

D = dummy variable for countries, where UK = United Kingdom, GE = FRG, BE = Belgium, NE = Netherlands, FR = France, IT = Italy;

and

top figures are estimated coefficients;

figures in parentheses are standard errors of coefficients;

figures in brackets are t-statistics.

Table 21. Results for pooled sample, energy.

| | | | |
|--|--|---|--------------------|
| $q_t = 3.120$ (0.120) [25.600] | $- 0.580$ (0.110) [5.200] | $\begin{bmatrix} 4 \\ \Sigma \\ \theta=0 \end{bmatrix}$ | $0.2 p_{t-\theta}$ |
| | $- 0.050$ (0.120) [0.400] | $\begin{bmatrix} 1 \\ \Sigma \\ \theta=0 \end{bmatrix}$ | $0.5 y_{t-\theta}$ |
| $D(\text{UK}) = -0.370$ (0.060) 5.800 | $D(\text{GE}) = -0.210$ (0.070) 3.000 | $D(\text{BE}) = -0.600$ (0.060) 9.200 | |
| $D(\text{NE}) = -0.630$ (0.040) [13.500] | $D(\text{FR}) = -0.910$ (0.070) [12.800] | $D(\text{IT}) = -1.410$ (0.060) [23.200] | |
| $R^2 = 0.981$ | | $D.W. = 0.760$ | |
| $\bar{R}^2 = 0.979$ | | $\text{corrected D.W.} = 0.660$ | |
| $SEE = 0.079$ | | $\text{observations} = 82.000$ | |

where

q_t = log (per capita net energy consumption);
 p_t = log (price of net energy/GDP deflator);
 y_t = log (real per capita GDP);
 D = dummy variable for countries, where UK = United Kingdom, GE = FRG, BE = Belgium, NE = Netherlands, FR = France, IT = Italy;

and

top figures are estimated coefficients;
 figures in parentheses are standard errors of coefficients;
 figures in brackets are t-statistics.

Table 22. Results for pooled sample, transport.

| | | | | | | | | |
|-------------|-----|-----------------------------------|-------|-----------------------------------|---|---|--------------------|------------------------------|
| q_t | $=$ | 1.840 (0.230) $[1.500]$ | $-$ | 0.360 (0.120) $[3.300]$ | $\left[\begin{array}{l} 4 \\ \Sigma \\ \theta=0 \end{array} \right.$ | $0.2 p_{t-\theta}$ | | |
| | | | | $+$ | 1.340 (0.800) $[16.600]$ | $\left[\begin{array}{l} 1 \\ \Sigma \\ \theta=0 \end{array} \right.$ | $0.5 y_{t-\theta}$ | |
| D(UK) | = | -0.370 (0.060) 6.600 | D(GE) | = | -0.630 (0.050) 12.500 | D(BE) | = | -0.590 (0.060) [9.200] |
| D(NE) | = | -0.440 (0.050) [8.300] | D(FR) | = | -0.740 (0.090) [8.200] | D(IT) | = | -0.350 (0.060) [5.800] |
| R^2 | = | 0.995 | | | | D.W. | = | 0.660 |
| \bar{R}^2 | = | 0.994 | | | | corrected D.W. | = | 0.550 |
| SEE | = | 0.047 | | | | observations | = | 82.000 |

where

q_t = log (per capita net energy consumption);
 p_t = log (price of net energy/GDP deflator);
 y_t = log (real per capita GDP);
D = dummy variable for countries, where UK = United Kingdom, GE = FRG, BE = Belgium, NE = Netherlands, FR = France, IT = Italy;

and

top figures are estimated coefficients;
figures in parentheses are standard errors of coefficients;
figures in brackets are t-statistics.

between the coefficients seriously, they indicate that the demand for energy is most inelastic in the transport sector, followed by intermediate values for industry other than energy and energy, and that the residential sector is most elastic. The relative inelasticity of the transport sector is quite plausible, since there is probably least possibility for technological substitution in this field. On the other hand, the relatively high elasticity of the residential sector is not so obvious from a theoretical point of view.

The results for the income terms are quite striking. The income elasticities are 1.34 (± 0.08) for the transportation sector, 1.09 (± 0.12) for the residential sector, .76 (± 0.17) for the industry-except-energy sector, and -0.05 (± 0.12) for the energy sector. For the aggregate the elasticity is estimated to be .79 (± 0.08). Again the income elasticities are plausible from an a priori point of view. It is well known that private automobiles are both highly income elastic and relatively energy-intensive, so that the high income elasticity of transportation is not surprising. More surprising, however, is that the energy sector has negative elasticity; this simply indicates that the losses in the transformation process are not related to income--nor is there any clear reason why they should be. The other sectors show elasticities in the neighborhood of unity or below unity. In the aggregate, the income-elasticity is significantly below unity.

In considering these results, three important differences from other studies should be noted: First, the results are found by pooling seven countries. As can be seen by comparing with the results from individual countries, results from exactly the same specification are unrecognizably different. Second, the concept of energy consumption is net energy, whereas most other studies for sectors examine gross energy. Since the general trend has been toward more efficient fuels (natural gas and electricity as compared to coal), this leads to a more rapid growth of net energy. Third, the demands are for the entire sector rather than a single fuel (e.g. electricity or natural gas) in a sector as an economy.

The next question to which we turn is whether there appear to be significant differences between the countries. Estimates of these differences are given by the dummy variables in the regressions. Recall that the dummy variables indicate whether the country appears different from the United States. First examining the aggregate equation shown in Table 18, we find that the differences are only marginally significant. The ranking of economies by energy-intensiveness is Belgium, the UK, the US, the FRG, the Netherlands, France and Italy. Recall that these intensities are after correction for prices and income. The pattern of results varies for different sectors, however. Thus the United States is highly energy-intensive in transport and energy, but in the middle of the pack in the domestic and the non-energy industrial sector.

We have also shown plots of the regressions for the four disaggregate sectors in Figures 2 through 6. The general quality of the fit and the overall trends can easily be judged from these graphs. As a visual guide, it should be noted that the average levels for each country are determined by the dummy variables, while the slopes, or fit for individual years, are determined from the regression coefficients. While the dummy variables guarantee that the average level for each country will be approximately correct, there is absolutely no guarantee that the general patterns of fit (or the trends for each country) will be accurate. Thus we have, roughly speaking, seven trends, corresponding to seven countries, while we have fit two coefficients. Considering the diversity and the fact that only two slope coefficients are fit for each regression, the degree of precision of the estimate is quite encouraging.

There is a troubling lack of elegance about the use of dummy variables: these are admissions that the specifications are rather weak. In addition, they may throw away considerable information about the effects of international difference in prices and incomes on international differences in energy intensiveness. For this reason it is useful to perform our

| Period | Y | YC | I | *...Observed Values | +...Computed Values | I | RES | RES % | I |
|--------|-------|-------|---|---------------------|---------------------|---|-------|---------|---|
| 1 | .595 | .735 | I | * | | I | -.140 | -23.460 | I |
| 2 | .706 | .822 | I | * | | I | -.116 | -16.395 | I |
| 3 | .791 | .872 | I | * | | I | -.076 | -9.887 | I |
| 4 | .863 | .906 | I | * | | I | -.043 | -5.029 | I |
| 5 | .955 | .961 | I | * | | I | -.006 | -.618 | I |
| 6 | 1.011 | 1.031 | I | * | | I | -.020 | -1.935 | I |
| 7 | 1.093 | 1.073 | I | * | | I | .020 | 1.798 | I |
| 8 | 1.124 | 1.082 | I | * | | I | .042 | 3.708 | I |
| 9 | 1.182 | 1.130 | I | * | | I | .052 | 4.372 | I |
| 10 | 1.277 | 1.228 | I | * | | I | .048 | 3.790 | I |
| 11 | 1.372 | 1.312 | I | * | | I | .060 | 4.351 | I |
| 12 | 1.450 | 1.361 | I | * | | I | .089 | 6.165 | I |
| 13 | 1.486 | 1.394 | I | * | | I | .092 | 6.192 | I |
| 14 | .549 | .556 | I | () | | I | -.007 | -1.286 | I |
| 15 | .606 | .586 | I | () | | I | .021 | 3.430 | I |
| 16 | .667 | .644 | I | + | | I | .023 | 3.387 | I |
| 17 | .733 | .732 | I | + | | I | .001 | -.123 | I |
| 18 | .816 | .823 | I | + | | I | -.007 | -.872 | I |
| 19 | .875 | .905 | I | + | | I | -.030 | -3.467 | I |
| 20 | .996 | .975 | I | + | | I | .022 | 2.192 | I |
| 21 | 1.026 | 1.022 | I | + | | I | .004 | .366 | I |
| 22 | 1.064 | 1.090 | I | + | | I | -.025 | -2.383 | I |
| 23 | .627 | .714 | I | * | | I | -.087 | -13.909 | I |
| 24 | .714 | .782 | I | * | | I | -.068 | -9.530 | I |
| 25 | .775 | .807 | I | * | | I | -.032 | -4.073 | I |
| 26 | .852 | .843 | I | * | | I | .009 | 1.092 | I |
| 27 | .922 | .880 | I | * | | I | .041 | 4.464 | I |
| 28 | .994 | .949 | I | * | | I | .046 | 4.584 | I |
| 29 | 1.055 | 1.035 | I | * | | I | .020 | 1.938 | I |
| 30 | 1.106 | 1.082 | I | * | | I | .024 | 2.188 | I |
| 31 | 1.180 | 1.132 | I | * | | I | .048 | 4.056 | I |
| 32 | 1.239 | 1.214 | I | * | | I | .025 | 2.004 | I |
| 33 | 1.302 | 1.307 | I | * | | I | -.004 | -.338 | I |
| 34 | 1.392 | 1.393 | I | * | | I | -.001 | -.087 | I |
| 35 | 1.435 | 1.458 | I | * | | I | -.024 | -1.645 | I |
| 36 | 1.491 | 1.468 | I | * | | I | .003 | -.183 | I |
| 37 | .540 | .525 | I | () | | I | .015 | 2.781 | I |
| 38 | .609 | .585 | I | () | | I | .024 | 3.989 | I |
| 39 | .681 | .661 | I | () | | I | .020 | 2.949 | I |
| 40 | .742 | .734 | I | () | | I | .008 | 1.114 | I |
| 41 | .818 | .802 | I | () | | I | .016 | 1.947 | I |
| 42 | .889 | .872 | I | + | | I | .017 | 1.912 | I |
| 43 | .944 | .937 | I | + | | I | .007 | .786 | I |
| 44 | .998 | .996 | I | + | | I | .002 | -.168 | I |
| 45 | 1.065 | 1.060 | I | + | | I | .005 | .495 | I |
| 46 | 1.124 | 1.120 | I | + | | I | -.004 | -.336 | I |
| 47 | 1.192 | 1.203 | I | + | | I | -.011 | -.896 | I |
| 48 | 1.257 | 1.291 | I | + | | I | -.034 | -2.691 | I |
| 49 | 1.313 | 1.360 | I | + | | I | -.047 | -3.563 | I |
| 50 | 1.397 | 1.424 | I | + | | I | -.027 | -1.964 | I |
| 51 | 2.356 | 2.237 | I | + | + | I | .119 | 5.069 | I |
| 52 | 2.366 | 2.279 | I | + | + | I | .087 | 3.680 | I |
| 53 | 2.371 | 2.288 | I | + | + | I | .083 | 3.481 | I |
| 54 | 2.405 | 2.325 | I | + | + | I | .080 | 3.310 | I |
| 55 | 2.429 | 2.378 | I | + | + | I | .051 | 2.096 | I |
| 56 | 2.440 | 2.425 | I | + | + | I | .015 | .629 | I |
| 57 | 2.466 | 2.489 | I | + | + | I | -.023 | -.945 | I |
| 58 | 2.505 | 2.563 | I | + | + | I | -.059 | -2.340 | I |
| 59 | 2.538 | 2.615 | I | + | + | I | -.077 | -3.023 | I |
| 60 | 2.597 | 2.656 | I | + | + | I | -.059 | -2.273 | I |
| 61 | 2.628 | 2.700 | I | + | + | I | -.071 | -2.716 | I |
| 62 | 2.641 | 2.706 | I | + | + | I | -.064 | -2.431 | I |
| 63 | 2.675 | 2.715 | I | + | + | I | -.040 | -1.488 | I |
| 64 | 2.729 | 2.770 | I | + | + | I | -.042 | -1.531 | I |
| 65 | 1.052 | 1.077 | I | + | | I | -.025 | -2.336 | I |
| 66 | 1.118 | 1.146 | I | + | | I | -.029 | -2.568 | I |
| 67 | 1.156 | 1.200 | I | + | | I | -.043 | -3.760 | I |
| 68 | 1.195 | 1.231 | I | + | | I | -.036 | -3.042 | I |
| 69 | 1.268 | 1.262 | I | + | | I | .006 | .453 | I |
| 70 | 1.321 | 1.305 | I | + | | I | .015 | 1.154 | I |
| 71 | 1.351 | 1.341 | I | + | | I | .010 | .742 | I |
| 72 | 1.398 | 1.371 | I | + | | I | .027 | 1.930 | I |
| 73 | 1.435 | 1.400 | I | + | | I | .035 | 2.459 | I |
| 74 | 1.470 | 1.430 | I | + | | I | .040 | 2.708 | I |

Note: Observed values are denoted by an asterisk. Actual values are denoted by a plus sign.

Figure 2. Results for transport sector: various years.

| Period | Y | YC | I | *...Observed values | +...Computed values | I | RES | RES % | I |
|--------|-----------|-------|-----|---------------------|---------------------|---|-------|--------|---|
| 1 | 3.988 | 3.879 | I | | + * | I | .110 | 2.752 | I |
| 2 | 3.990 | 3.946 | I | | +* | I | .043 | 1.087 | I |
| 3 | 4.027 | 3.982 | I | | ++ | I | .046 | 1.133 | I |
| 4 | 4.074 | 4.011 | I | | + * | I | .062 | 1.527 | I |
| 5 | 4.110 | 4.069 | I | | ++ | I | .042 | 1.010 | I |
| 6 | 4.123 | 4.139 | I | | ++ | I | -.016 | -.381 | I |
| 7 | 4.123 | 4.180 | I | | * + | I | -.057 | -1.386 | I |
| 8 | 4.126 | 4.176 | I | | * + | I | -.050 | -1.213 | I |
| 9 | 4.198 | 4.211 | I | | ++ | I | -.013 | -.305 | I |
| 10 | 4.301 | 4.314 | I | | () | I | -.013 | -.305 | I |
| 11 | 4.348 | 4.393 | I | | * + | I | -.046 | -1.052 | I |
| 12 | 4.339 | 4.414 | I | | * + | I | -.074 | -1.715 | I |
| 13 | 4.384 | 4.418 | I | | ++ | I | -.033 | -.764 | I |
| 14 | 3.186 | 3.296 | I** | | | I | -.109 | -3.432 | I |
| 15 | 3.269 | 3.325 | I** | | | I | -.055 | -1.696 | I |
| 16 | 3.348 | 3.374 | I | () | | I | -.027 | -.792 | I |
| 17 | 3.411 | 3.440 | I | ** | Italy | I | -.029 | -.856 | I |
| 18 | 3.487 | 3.516 | I | () | | I | -.029 | -.819 | I |
| 19 | 3.578 | 3.590 | I | () | | I | -.012 | -.328 | I |
| 20 | 3.749 | 3.660 | I | | + * | I | .089 | 2.387 | I |
| 21 | 3.744 | 3.678 | I | | ++ | I | .066 | 1.763 | I |
| 22 | 3.843 | 3.738 | I | | + * | I | .105 | 2.741 | I |
| 23 | 3.380 | 3.525 | I | * + | | I | -.145 | -4.304 | I |
| 24 | 3.468 | 3.575 | I | * + | | I | -.107 | -3.081 | I |
| 25 | 3.502 | 3.584 | I | * + | | I | -.082 | -2.331 | I |
| 26 | 3.596 | 3.623 | I | ++ | | I | -.027 | -.746 | I |
| 27 | 3.688 | 3.663 | I | ++ | Netherlands | I | .024 | .657 | I |
| 28 | 3.721 | 3.738 | I | () | | I | -.017 | -.445 | I |
| 29 | 3.801 | 3.833 | I | | ++ | I | -.032 | -.833 | I |
| 30 | 3.840 | 3.876 | I | | ++ | I | -.035 | -.922 | I |
| 31 | 3.910 | 3.912 | I | | () | I | -.002 | -.039 | I |
| 32 | 4.053 | 3.994 | I | | + * | I | .058 | 1.440 | I |
| 33 | 4.144 | 4.099 | I | | ++ | I | .045 | 1.080 | I |
| 34 | 4.269 | 4.186 | I | | + * | I | .083 | 1.937 | I |
| 35 | 4.314 | 4.252 | I | | ++ | I | .062 | 1.438 | I |
| 36 | 4.459 | 4.285 | I | | + * | I | .174 | 3.901 | I |
| 37 | 3.421 | 3.450 | I | ** | | I | -.029 | -.847 | I |
| 38 | 3.498 | 3.458 | I | ++ | | I | .040 | 1.134 | I |
| 39 | 3.522 | 3.493 | I | () | | I | .029 | .830 | I |
| 40 | 3.586 | 3.535 | I | ++ | | I | .051 | 1.418 | I |
| 41 | 3.658 | 3.581 | I | ++ | France | I | .077 | 2.107 | I |
| 42 | 3.709 | 3.648 | I | ++ | | I | .060 | 1.631 | I |
| 43 | 3.751 | 3.719 | I | ++ | | I | .032 | .863 | I |
| 44 | 3.765 | 3.782 | I | () | | I | -.017 | -.453 | I |
| 45 | 3.822 | 3.849 | I | ++ | | I | -.027 | -.713 | I |
| 46 | 3.886 | 3.915 | I | ++ | | I | -.029 | -.736 | I |
| 47 | 3.956 | 3.996 | I | ++ | | I | -.040 | -.999 | I |
| 48 | 4.032 | 4.072 | I | ++ | | I | -.040 | -.985 | I |
| 49 | 4.046 | 4.109 | I | ++ | | I | -.063 | -1.553 | I |
| 50 | 4.093 | 4.138 | I | ++ | | I | -.046 | -1.117 | I |
| 51 | 4.679 | 4.615 | I | | + * | I | .064 | 1.377 | I |
| 52 | 4.713 | 4.645 | I | | + * | I | .069 | 1.455 | I |
| 53 | 4.709 | 4.642 | I | | + * | I | .067 | 1.414 | I |
| 54 | 4.744 | 4.677 | I | | + * | I | .067 | 1.413 | I |
| 55 | 4.764 | 4.732 | I | | () | I | .032 | .668 | I |
| 56 | 4.793 | 4.785 | I | | () | I | .009 | .178 | I |
| 57 | 4.829 | 4.855 | I | | ++ | I | -.027 | -.551 | I |
| 58 | 4.874 | 4.935 | I | | ++ | I | -.062 | -1.262 | I |
| 59 | 4.894 | 4.983 | I | | ++ | I | -.089 | -1.824 | I |
| 60 | 4.938 | 5.016 | I | | + * | I | -.078 | -1.582 | I |
| 61 | 4.986 | 5.046 | I | | + * | I | -.060 | -1.200 | I |
| 62 | 5.014 | 5.031 | I | | ++ | I | -.017 | -.331 | I |
| 63 | 5.015 | 5.012 | I | | () | I | .004 | .070 | I |
| 64 | 5.068 | 5.046 | I | | () | I | .022 | .426 | I |
| 65 | I 4.038 * | 4.045 | I | | () | I | -.007 | | I |
| 66 | 4.053 | 4.089 | I | | () | I | -.036 | -.894 | I |
| 67 | 4.090 | 4.116 | I | | () | I | -.026 | -.636 | I |
| 68 | 4.079 | 4.116 | I | | ++ | I | -.037 | -.911 | I |
| 69 | 4.071 | 4.121 | I | | ++ | I | -.050 | -1.225 | I |
| 70 | 4.107 | 4.130 | I | | ++ | I | -.024 | -.578 | I |
| 71 | 4.138 | 4.141 | I | | () | I | -.003 | -.072 | I |
| 72 | 4.200 | 4.146 | I | | ++ | I | .054 | 1.296 | I |
| 73 | 4.196 | 4.144 | I | | ++ | I | .052 | 1.234 | I |
| 74 | 4.223 | 4.146 | I | | + * | I | .077 | 1.821 | I |

Note: Observed values are denoted by an asterisk. Actual values are denoted by a plus sign.

Figure 3. Results for aggregate sector: various years.

| Period | Y | YC | I | *...Observed values | +...Computed values | I | RES | RES % | I |
|--------|-------|-------|----|---------------------|---------------------|---|--------|--------|---|
| 1 | 2.241 | 2.284 | I | ** | | I | -.043 | -1.901 | I |
| 2 | 2.341 | 2.390 | I | ** | | I | -.049 | -2.104 | I |
| 3 | 2.532 | 2.476 | I | ** | | I | .056 | 2.222 | I |
| 4 | 2.678 | 2.564 | I | ** | | I | .114 | 4.241 | I |
| 5 | 2.689 | 2.680 | I | () | | I | .009 | .346 | I |
| 6 | 2.769 | 2.810 | I | ** | Federal Republic | I | -.041 | -1.480 | I |
| 7 | 2.837 | 2.910 | I | ** | of Germany | I | -.074 | -2.594 | I |
| 8 | 2.876 | 2.931 | I | ** | | I | -.055 | -1.908 | I |
| 9 | 2.991 | 2.992 | I | () | | I | -.001 | -.046 | I |
| 10 | 3.126 | 3.124 | I | ** | | I | .002 | .062 | I |
| 11 | 3.219 | 3.218 | I | () | | I | .000 | .008 | I |
| 12 | 3.248 | 3.237 | I | () | | I | .011 | .336 | I |
| 13 | 3.320 | 3.250 | I | + | * | I | .070 | 2.122 | I |
| 14 | 1.675 | 1.780 | I* | + | | I | -.105 | -6.264 | I |
| 15 | 1.812 | 1.813 | I | () | | I | -.001 | -.033 | I |
| 16 | 1.878 | 1.895 | I | () | | I | -.017 | -.906 | I |
| 17 | 2.050 | 2.019 | I | () | | I | .031 | 1.509 | I |
| 18 | 2.161 | 2.156 | I | ** | Italy | I | .005 | .227 | I |
| 19 | 2.295 | 2.300 | I | () | | I | -.005 | -.230 | I |
| 20 | 2.445 | 2.430 | I | () | | I | .015 | .630 | I |
| 21 | 2.560 | 2.515 | I | ** | | I | .045 | 1.772 | I |
| 22 | 2.651 | 2.620 | I | ** | | I | .031 | 1.178 | I |
| 23 | 2.159 | 2.246 | I | ** | | I | -.087 | -4.050 | I |
| 24 | 2.258 | 2.330 | I | ** | | I | -.071 | -3.158 | I |
| 25 | 2.338 | 2.373 | I | ** | | I | -.035 | -1.495 | I |
| 26 | 2.510 | 2.467 | I | ** | | I | .043 | 1.701 | I |
| 27 | 2.662 | 2.553 | I | + | * | I | .108 | .071 | I |
| 28 | 2.697 | 2.664 | I | ** | Netherlands | I | .033 | 1.234 | I |
| 29 | 2.811 | 2.815 | I | () | | I | -.004 | -.130 | I |
| 30 | 2.877 | 2.905 | I | ** | | I | -.027 | -.955 | I |
| 31 | 2.955 | 2.989 | I | ** | | I | -.033 | -1.127 | I |
| 32 | 3.153 | 3.134 | I | () | | I | .019 | .609 | I |
| 33 | 3.331 | 3.316 | I | ** | | I | .015 | .464 | I |
| 34 | 3.463 | 3.454 | I | () | | I | .008 | .241 | I |
| 35 | 3.530 | 3.562 | I | ** | | I | -.033 | -.928 | I |
| 36 | 3.702 | 3.638 | I | ** | | I | .064 | 1.718 | I |
| 37 | 1.843 | 1.974 | I | * | + | I | -.131 | -7.109 | I |
| 38 | 1.927 | 1.982 | I | ** | | I | -.055 | -2.851 | I |
| 39 | 1.973 | 2.014 | I | ** | | I | -.041 | -2.086 | I |
| 40 | 2.135 | 2.075 | I | ** | | I | .060 | 2.827 | I |
| 41 | 2.273 | 2.129 | I | + | * | I | .144 | 6.337 | I |
| 42 | 2.312 | 2.229 | I | ** | | I | .083 | 3.580 | I |
| 43 | 2.385 | 2.338 | I | ** | | I | .048 | 1.992 | I |
| 44 | 2.411 | 2.441 | I | () | | I | -.030 | -1.249 | I |
| 45 | 2.526 | 2.542 | I | () | | I | -.016 | -.622 | I |
| 46 | 2.624 | 2.648 | I | ** | | I | 8-.024 | -.932 | I |
| 47 | 2.693 | 2.771 | I | ** | | I | -.078 | -2.887 | I |
| 48 | 2.785 | 2.870 | I | ** | | I | -.085 | -3.055 | I |
| 49 | 2.944 | 2.925 | I | ** | | I | .019 | .660 | I |
| 50 | 3.094 | 2.987 | I | + | * | I | .106 | 3.431 | I |
| 51 | 3.620 | 3.559 | I | + | * | I | .061 | 1.687 | I |
| 52 | 3.660 | 3.600 | I | + | * | I | .060 | 1.646 | I |
| 53 | 3.677 | 3.604 | I | + | * | I | .073 | 1.990 | I |
| 54 | 3.721 | 3.650 | I | + | * | I | .071 | 1.901 | I |
| 55 | 3.728 | 3.707 | I | () | | I | .021 | .556 | I |
| 56 | 3.744 | 3.761 | I | ** | | I | -.017 | -.442 | I |
| 57 | 3.795 | 3.834 | I | United States | | I | -.040 | -1.049 | I |
| 58 | 3.843 | 3.921 | I | ** | | I | -.078 | -2.036 | I |
| 59 | 3.877 | 3.974 | I | ** | | I | -.097 | -2.505 | I |
| 60 | 3.925 | 4.013 | I | ** | | I | -.088 | -2.243 | I |
| 61 | 3.986 | 4.051 | I | ** | | I | -.065 | -1.628 | I |
| 62 | 4.047 | 4.039 | I | ** | | I | .009 | .201 | I |
| 63 | 4.054 | 4.017 | I | ** | | I | .037 | .916 | I |
| 64 | 4.092 | 2.038 | I | ** | | I | .053 | 1.305 | I |
| 65 | 2.798 | 2.739 | I | ** | | I | .060 | 2.135 | I |
| 66 | 2.782 | 2.803 | I | ** | | I | -.022 | -.774 | I |
| 67 | 2.830 | 2.855 | I | ** | | I | -.025 | -.870 | I |
| 68 | 2.842 | 2.878 | I | () | | I | -.036 | -1.267 | I |
| 69 | 2.867 | 2.908 | I | ** | United Kingdom | I | -.041 | -1.441 | I |
| 70 | 2.923 | 2.941 | I | ** | | I | -.018 | -.619 | I |
| 71 | 2.954 | 2.974 | I | () | | I | -.020 | -.676 | I |
| 72 | 3.008 | 2.999 | I | () | | I | .010 | .317 | I |
| 73 | 3.036 | 3.014 | I | + | * | I | .022 | .714 | I |
| 74 | 3.093 | 3.023 | I | + | * | I | .071 | 2.283 | I |

Note: Observed values are denoted by an asterisk. Actual values are denoted by a plus sign.

Figure 4. Results for domestic sector: various years.

| Period | Y | YC | I | *...Observed values | +...Computed values | I | RES | RES % | I |
|--------|--------|-------|---|---------------------|---------------------|---|-------|--------|---|
| 1 | 3.377 | 3.186 | I | | + | I | .191 | 5.663 | I |
| 2 | 3.354 | 3.250 | I | | + | I | .103 | 3.086 | I |
| 3 | 3.354 | 3.290 | I | | + | I | .065 | 1.927 | I |
| 4 | 3.359 | 3.322 | I | | + | I | .037 | 2.094 | I |
| 5 | 3.414 | 3.376 | I | | + | I | .039 | 1.136 | I |
| 6 | 3.429 | 3.432 | I | | + | I | -.010 | -.292 | I |
| 7 | 3.402 | 3.472 | I | | + | I | -.070 | -2.070 | I |
| 8 | 3.405 | 3.474 | I | | + | I | -.069 | -2.026 | I |
| 9 | 3.465 | 3.508 | I | | + | I | -.043 | -1.227 | I |
| 10 | 3.575 | 3.592 | I | | + | I | -.018 | -.491 | I |
| 11 | 3.610 | 3.661 | I | | + | I | -.051 | -1.413 | I |
| 12 | 3.569 | 3.681 | I | | + | I | -.112 | -3.143 | I |
| 13 | 3.621a | 3.685 | I | | + | I | -.062 | -1.719 | I |
| 14 | 2.649 | 2.745 | I | * | + | I | -.096 | -3.627 | I |
| 15 | 2.716 | 2.770 | I | * | + | I | -.054 | -1.973 | I |
| 16 | 2.796 | 2.805 | I | | () | I | -.009 | -.329 | I |
| 17 | 2.808 | 2.857 | I | * | + | I | -.049 | -1.738 | I |
| 18 | 2.876 | 2.919 | I | * | + | I | -.043 | -1.492 | I |
| 19 | 2.955 | 2.978 | I | | () | I | -.023 | -.785 | I |
| 20 | 3.165 | 3.037 | I | | + | I | .129 | 4.069 | I |
| 21 | 3.099 | 3.064 | I | | + | I | .035 | 1.139 | I |
| 22 | 3.234 | 3.125 | I | | + | I | .110 | 3.391 | I |
| 23 | 2.443 | 2.522 | I | * | + | I | -.080 | -3.263 | I |
| 24 | 2.523 | 2.570 | I | * | + | I | -.047 | -1.856 | I |
| 25 | 2.524 | 2.585 | I | * | + | I | -.061 | -2.428 | I |
| 26 | 2.588 | 2.626 | I | * | + | I | -.039 | -1.488 | I |
| 27 | 2.657 | 2.667 | I | | () | I | -.010 | -.386 | I |
| 28 | 2.706 | 2.734 | I | * | + | I | -.027 | -1.007 | I |
| 29 | 2.762 | 2.817 | I | * | + | I | -.055 | -1.975 | I |
| 30 | 2.785 | 2.856 | I | * | + | I | -.071 | -2.546 | I |
| 31 | 2.737 | 2.880 | I | * | + | I | -.142 | -5.197 | I |
| 32 | 3.048 | 2.946 | I | | + | I | .101 | 3.326 | I |
| 33 | 3.071 | 3.026 | I | | + | I | .045 | 2.456 | I |
| 34 | 3.180 | 3.089 | I | | + | I | .091 | 2.852 | I |
| 35 | 3.200 | 3.131 | I | | + | I | .069 | 2.157 | I |
| 36 | 3.385 | 3.159 | I | | + | I | .226 | 6.671 | I |
| 37 | 2.850 | 2.868 | I | | () | I | -.018 | -.633 | I |
| 38 | 2.943 | 2.871 | I | | + | I | .072 | 2.433 | I |
| 39 | 2.971 | 2.898 | I | | + | I | .073 | 2.462 | I |
| 40 | 3.019 | 2.934 | I | | + | I | .085 | 2.809 | I |
| 41 | 3.066 | 2.978 | I | | + | I | .088 | 2.864 | I |
| 42 | 3.115 | 3.039 | I | | + | I | .076 | 2.442 | I |
| 43 | 3.145 | 3.101 | I | | + | I | .045 | 1.425 | I |
| 44 | 3.144 | 3.152 | I | | + | I | -.008 | -.261 | I |
| 45 | 3.178 | 3.209 | I | | + | I | -.031 | -.961 | I |
| 46 | 3.235 | 3.262 | I | | + | I | -.027 | -.829 | I |
| 47 | 3.304 | 3.331 | I | | + | I | -.027 | -.831 | I |
| 48 | 3.376 | 3.394 | I | | + | I | -.018 | -.528 | I |
| 49 | 3.287 | 3.418 | I | | + | I | -.131 | -3.974 | I |
| 50 | 3.258 | 3.436 | I | | + | I | -.179 | -5.487 | I |
| 51 | 3.603 | 3.626 | I | | + | I | -.023 | -.626 | I |
| 52 | 3.654 | 3.643 | I | | + | I | .011 | .292 | I |
| 53 | 3.627 | 3.636 | I | | () | I | -.010 | -.266 | I |
| 54 | 3.657 | 3.657 | I | | () | I | -.001 | -.014 | I |
| 55 | 3.690 | 3.697 | I | | + | I | -.006 | -.176 | I |
| 56 | 3.761 | 3.738 | I | | + | I | .023 | .623 | I |
| 57 | 3.821 | 3.796 | I | | + | I | .024 | .634 | I |
| 58 | 3.870 | 3.864 | I | | () | I | .005 | .138 | I |
| 59 | 3.874 | 3.911 | I | | + | I | -.037 | -.952 | I |
| 60 | 3.903 | 3.946 | I | | + | I | -.043 | -1.096 | I |
| 61 | 3.943 | 3.977 | I | | + | I | -.034 | -.860 | I |
| 62 | 3.987 | 3.970 | I | | + | I | .017 | .433 | I |
| 63 | 3.957 | 3.955 | I | | () | I | .003 | .069 | I |
| 64 | 4.047 | 3.978 | I | | + | I | .069 | 1.704 | I |
| 65 | 3.252 | 3.259 | I | | () | I | -.007 | -.209 | I |
| 66 | 3.293 | 3.304 | I | | () | I | -.011 | -.328 | I |
| 67 | 3.335 | 3.335 | I | | () | I | .001 | .016 | I |
| 68 | 3.313 | 3.345 | I | | + | I | -.032 | -.975 | I |
| 69 | 3.285 | 3.357 | I | * | + | I | -.072 | -2.195 | I |
| 70 | 3.318 | 3.372 | I | * | + | I | -.055 | -1.644 | I |
| 71 | 3.394 | 3.391 | I | | () | I | .003 | .098 | I |
| 72 | 3.471 | 3.405 | I | | + | I | .066 | 1.913 | I |
| 73 | 3.445 | 3.406 | I | | + | I | .039 | 1.141 | I |
| 74 | 3.480 | 3.413 | I | | + | I | .067 | 1.924 | I |

Note: Observed values are denoted by an asterisk. Actual values are denoted by a plus sign.

Figure 5. Results for industry except energy sector: various years.

| Period | Y | YC | I | *...Observed values | +...Computed values | I | RES | RES % | I | |
|-----------------------------|-------|-------|----|---------------------|---------------------|---|-------|---------|---|--|
| 1 | 2.598 | 2.431 | I | | + * | I | .168 | 6.447 | I | |
| 2 | 2.566 | 2.444 | I | | + * | I | .122 | 4.751 | I | |
| 3 | 2.539 | 2.448 | I | | + * | I | .091 | 3.584 | I | |
| 4 | 2.573 | 2.451 | I | | + * | I | .122 | 4.729 | I | |
| 5 | 2.584 | 2.470 | I | | + * | I | .114 | 4.423 | I | |
| 6 | 2.503 | 2.492 | I | | () | I | .011 | .437 | I | |
| 7 | 2.456 | 2.496 | I | | ++ | I | -.041 | -1.649 | I | |
| 8 | 2.399 | 2.487 | I | | * + | I | -.088 | -3.654 | I | |
| 9 | 2.433 | 2.492 | I | | ++ | I | -.059 | -2.444 | I | |
| 10 | 2.461 | 2.525 | I | | * + | I | -.064 | -2.606 | I | |
| 11 | 2.437 | 2.548 | I | | * + | I | -.111 | -4.553 | I | |
| 12 | 2.409 | 2.533 | I | | * + | I | -.124 | -5.156 | I | |
| 13 | 2.371 | 2.512 | I | | * + | I | -.140 | -5.923 | I | |
| Federal Republic of Germany | | | | | | | | | | |
| 14 | 1.092 | 1.210 | I* | + | | I | -.118 | -10.770 | I | |
| 15 | 1.164 | 1.251 | I* | + | | I | -.087 | -7.470 | I | |
| 16 | 1.274 | 1.291 | I | | () | I | -.018 | -1.387 | I | |
| 17 | 1.351 | 1.331 | I | | () | I | .020 | 1.449 | I | |
| 18 | 1.386 | 1.383 | I | | () | I | .003 | .233 | I | |
| 19 | 1.457 | 1.414 | I | | ++ | I | .043 | 2.931 | I | |
| 20 | 1.515 | 1.430 | I | | + | I | .086 | 5.655 | I | |
| 21 | 1.479 | 1.423 | I | | ++ | I | .056 | 3.757 | I | |
| 22 | 1.442 | 1.427 | I | | () | I | .016 | 1.076 | I | |
| Italy | | | | | | | | | | |
| 23 | 1.991 | 2.048 | I | | ++ | I | -.057 | -2.859 | I | |
| 24 | 2.081 | 2.066 | I | | () | I | .016 | .763 | I | |
| 25 | 2.102 | 2.077 | I | | () | I | .025 | 1.189 | I | |
| 26 | 2.142 | 2.113 | I | | () | I | .029 | 1.348 | I | |
| 27 | 2.183 | 2.140 | I | | ++ | I | .042 | 1.931 | I | |
| 28 | 2.174 | 2.182 | I | | () | I | -.008 | -.373 | I | |
| 29 | 2.244 | 2.230 | I | | ++ | I | .014 | .645 | I | |
| 30 | 2.255 | 2.257 | I | | () | I | -.002 | -.087 | I | |
| 31 | 2.485 | 2.302 | I | | + | I | .183 | 7.373 | I | |
| 32 | 2.266 | 2.354 | I | | * + | I | -.088 | -3.875 | I | |
| 33 | 2.290 | 2.421 | I | | * + | I | -.131 | -5.715 | I | |
| 34 | 2.440 | 2.460 | I | | + | I | -.021 | -.851 | I | |
| 35 | 2.474 | 2.478 | I | | () | I | -.004 | -.173 | I | |
| 36 | 2.478 | 2.477 | I | | () | I | .001 | .045 | I | |
| Netherlands | | | | | | | | | | |
| 37 | 1.664 | 1.719 | I | | * + | I | -.055 | -3.334 | I | |
| 38 | 1.681 | 1.699 | I | | () | I | -.018 | -1.069 | I | |
| 39 | 1.647 | 1.699 | I | | ++ | I | -.052 | -3.157 | I | |
| 40 | 1.623 | 1.704 | I | | ++ | I | -.081 | -4.987 | I | |
| 41 | 1.676 | 1.720 | I | | ++ | I | -.044 | -2.609 | I | |
| 42 | 1.748 | 1.753 | I | | () | I | -.006 | -.320 | I | |
| 43 | 1.775 | 1.792 | I | | () | I | -.017 | -.934 | I | |
| 44 | 1.812 | 1.823 | I | | () | I | -.011 | -.600 | I | |
| 45 | 1.842 | 1.859 | I | | ++ | I | -.017 | -.906 | I | |
| 46 | 1.865 | 1.887 | I | | ++ | I | -.022 | -1.200 | I | |
| 47 | 1.939 | 1.921 | I | | + | I | .018 | .950 | I | |
| 48 | 2.004 | 1.942 | I | | ++ | I | .062 | 3.088 | I | |
| 49 | 2.044 | 1.931 | I | | + | I | .113 | 5.550 | I | |
| 50 | 2.054 | 1.925 | I | | + | I | .128 | 6.257 | I | |
| France | | | | | | | | | | |
| 51 | 3.137 | 3.197 | I | | ++ | I | -.060 | -1.908 | I | |
| 52 | 3.146 | 3.189 | I | | ++ | I | -.043 | -1.360 | I | |
| 53 | 3.137 | 3.175 | I | | ++ | I | -.038 | -1.224 | I | |
| 54 | 3.168 | 3.182 | I | | ++ | I | -.014 | -.444 | I | |
| 55 | 3.187 | 3.189 | I | | () | I | -.002 | -.065 | I | |
| 56 | 3.173 | 3.194 | I | | () | I | -.021 | -.677 | I | |
| United States | | | | | | | | | | |
| 57 | 3.146 | 3.207 | I | | ++ | I | -.061 | -1.951 | I | |
| 58 | 3.177 | 3.225 | I | | ++ | I | -.048 | -1.501 | I | |
| 59 | 3.194 | 3.232 | I | | ++ | I | -.038 | -1.193 | I | |
| 60 | 3.253 | 3.235 | I | | () | I | .019 | .571 | I | |
| 61 | 3.301 | 3.239 | I | | ++ | I | .063 | 1.896 | I | |
| 62 | 3.236 | 3.214 | I | | () | I | .023 | .696 | I | |
| 63 | 3.265 | 3.176 | I | | + | I | .090 | 2.744 | I | |
| 64 | 3.275 | 3.142 | I | | + | I | .133 | 4.046 | I | |
| United Kingdom | | | | | | | | | | |
| 65 | 2.453 | 2.440 | I | | () | I | .014 | .552 | I | |
| 66 | 2.439 | 2.436 | I | | () | I | .002 | .093 | I | |
| 67 | 2.446 | 2.427 | I | | () | I | .020 | .804 | I | |
| 68 | 2.414 | 2.409 | I | | () | I | .005 | .198 | I | |
| 69 | 2.376 | 2.391 | I | | () | I | -.015 | -.624 | I | |
| 70 | 2.378 | 2.371 | I | | ++ | I | .006 | .268 | I | |
| 71 | 2.291 | 2.340 | I | | ++ | I | -.049 | -2.128 | I | |
| 72 | 2.326 | 2.318 | I | | () | I | .009 | .366 | I | |

Note: Observed values are denoted by an asterisk. Actual values are denoted by a plus sign.

Figure 6. Results for energy sector: various years.

calculations without dummy variables. This procedure then takes into account not only the effect of the histories of individual countries, but also the differences of levels of income and price between countries on energy intensiveness. To obtain this different perspective, we must make the further heroic assumption that the intercepts in all countries are the same and that omitted variables are uncorrelated with energy prices and income. The quality of the fit will deteriorate if country dummies are significant, but the results may shed further light on the long-run elasticities.

Table 23 shows the estimated coefficients for the case with and without country dummy variables. Two results are clear from this table: first, the results generally hold up without country variables. Second, the fits of the equation are much worse. In considering the two equations, there are good theoretical reasons to believe that the results without country variables should show larger price coefficients: in principle, the price differences are of longer duration, and the full response to these differences should have taken place. For the time series analysis of individual countries the length of response is only five years, which is clearly too short for the response function for energy.

Two general points come out of the results without dummy variables. First, it does not appear that the results are significantly different with two exceptions: a) in the transport sector the price elasticity is much higher while the income elasticity is lower; and b) in the energy sector the income elasticity is dramatically changed. With these exceptions, these results confirm quite strongly the results with the dummy variables.

The question is how to interpret the cases where the results are quite different. In general, I suspect that for transport the pooled results without country dummies should be given considerable attention. In this sector the differences between countries are pretty clearly due to the policy of taxing

Table 23. Comparison of results with and without country dummy variables.

| Sector | Price Elasticities | | Income Elasticities | | Goodness of Fit (\bar{R}^2) | |
|------------------------|--------------------|-----------------|---------------------|-----------------|---------------------------------|-----------------|
| | With Dummies | Without Dummies | With Dummies | Without Dummies | With Dummies | Without Dummies |
| Aggregate | -.85 (.10) | -1.15 (.10) | .79 (.08) | .87 (.09) | .988 | .916 |
| Transport | -.36 (.12) | -1.28 (.06) | 1.34 (.08) | .81 (.08) | .994 | .959 |
| Domestic | -.79 (.08) | -.71 (.09) | 1.09 (.12) | 1.39 (.12) | .990 | .857 |
| Industry except energy | -.52 (.17) | -.48 (.14) | .76 (.16) | .91 (.14) | .947 | .671 |
| Energy | -.58 (.11) | -.62 (.17) | -.05 (.12) | .94 (.23) | .979 | .606 |

gasoline heavily in European countries, rather than supply side differences. For this reason, I suspect that we are simply getting a longer run reaction than in the case of the results with country dummies, and therefore these seem to be more adequate results from a theoretical point of view. For the energy sector, on the other hand, I suspect that the differences are simply supply side differences, in particular differences in energy resource availability, rather than demand. Clearly, the reason the demand in the energy sector is high for the US, the UK and the FRG and low for Italy and France is owing to the resource endowments of the respective countries. The fact that wealthier countries happen to have larger energy resources is probably more accidental than causal. For this reason, the results with country dummies are probably preferable to the results without country dummies.

One must be quite cautious in use of the data without country dummies. In essence the effective number of observations is very small and the extremes (such as the United States for transport) are determining the coefficients: while the coefficients may be unbiased, the autocorrelation of the residuals means that the standard errors are very high. Thus, where the differences between the estimates with and without country dummies are large, the uncertainty about the long-run coefficients is also large. Particularly for the transport sector, the discrepancy is so large that we must look for further information to resolve the differences in estimates. On the other hand, the price elasticities for the domestic and industrial sectors agree quite well in both procedures, so these can be regarded as better determined.

VI. Projections for the United States

An important application of the results of the present study is in forecasting the growth of energy demand over the short and medium term. Forecasts of this kind remain one of the important tasks of the present study, and the current section is only a preliminary indication of the qualitative

results that will come out of a fully prepared forecast. Nevertheless, since the question of forecasts is of such great importance for planning purposes, it was thought useful to present the techniques and some preliminary estimates at this stage.

In making the forecasts, we have only relied upon calculations for the aggregate, rather than for individual sectors; and we have applied the projections only to the United States. However, since the estimates of the elasticities we use are from the pooled data, and since the magnitude of the shifts are approximately the same, the results for other OECD countries would be approximately the same. In projecting future demands, given model estimates of coefficients, the other determining factors are the relative prices of energy to non-energy goods and growth in per capita GNP. We have used the conventional figures for GNP growth--that "potential GNP" would grow at 4.0% from 1972 to 1985 and at 3.5% from 1985 to 2000, while population is taken as US Census series E.

More complicated is the question of price trends over the longer horizon. The results incorporate four different assumptions about relative price trends:

- 1) the "historical price series" which assumes that the declining relative price trend which was evidenced from 1955 to 1970 would continue indefinitely. This series shows a declining relative price trend of 1.2% annually;
- 2) the "constant 1974 price" series, which assumes that the discontinuity which occurred between 1970 and 1974 reflected irreversible structural shifts, and that the 1974 relative prices would maintain themselves indefinitely;
- 3) the "100% erosion of 1974 price" series, which assumes that the energy crisis of 1970-1975 was a transient phenomenon, due to temporary shortages and exercise of market power, and would be eroded

away over the period 1975-1985; and

- 4) the "50% erosion of 1974 price" which assumes that only 50% of the difference between the "historical" and "constant 1974" price series would be eroded by competitive forces.

It should be emphasized that the assumptions about price can only be guesses: not only do they reflect uncertain judgments about political and economic events--such as the strength of the cohesive bonds between producing nations or between consuming nations--but they may not even be consistent with the technological constraints of the energy sector; only when the demand model is combined with a more complete model of supply (such as the linear programming model in [49]) can the consistency be assured.

The major advantage of the econometric technique over non-statistical techniques is that it allows for estimating the uncertainty of the predictions. Therefore, in addition to the maximum likelihood point projections, we have also calculated the standard error of the forecasts as calculated by standard techniques (see Malinvaud [45], pp. 208 ff.).

In what follows, it should also be noted that because of autocorrelation of the errors the standard errors in our equations are underestimated (see Malinvaud [45], pp. 433-437). We have therefore made a crude correction by multiplying the standard errors of the coefficients by $\sqrt{2}$ and the standard error of the equation by $\sqrt{5}$.²⁴

The results are shown in Figures 7 and 8. The first point is that under most realistic scenarios about price there

²⁴Using $(1 - D.W./2)$ as an estimate of the autocorrelation coefficient for the errors, and using the fact that the composite right hand side variables have autocorrelation of about 0.4, we find that the standard error of the equation is expected to be underestimated by a factor of $\sqrt{5}$ and the standard error of the slopes by a factor of $\sqrt{2}$.

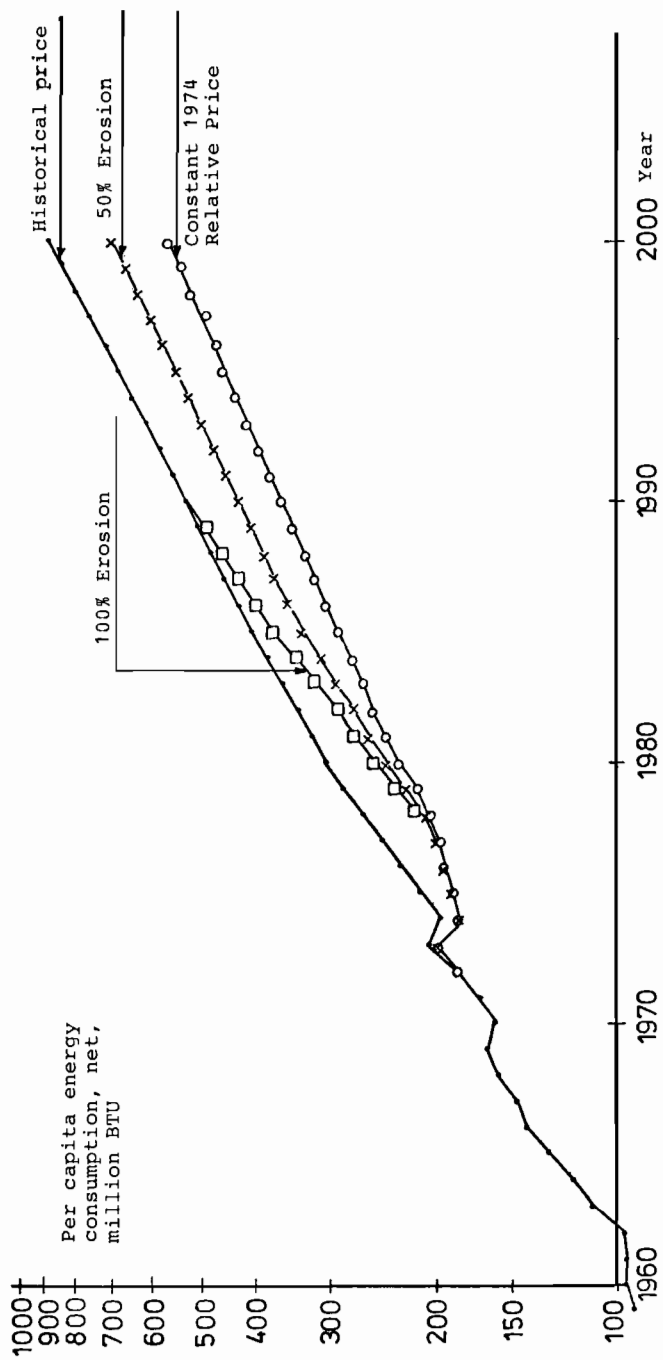

Figure 7. Projections for the United States, 1959 to 2000, various price hypotheses.

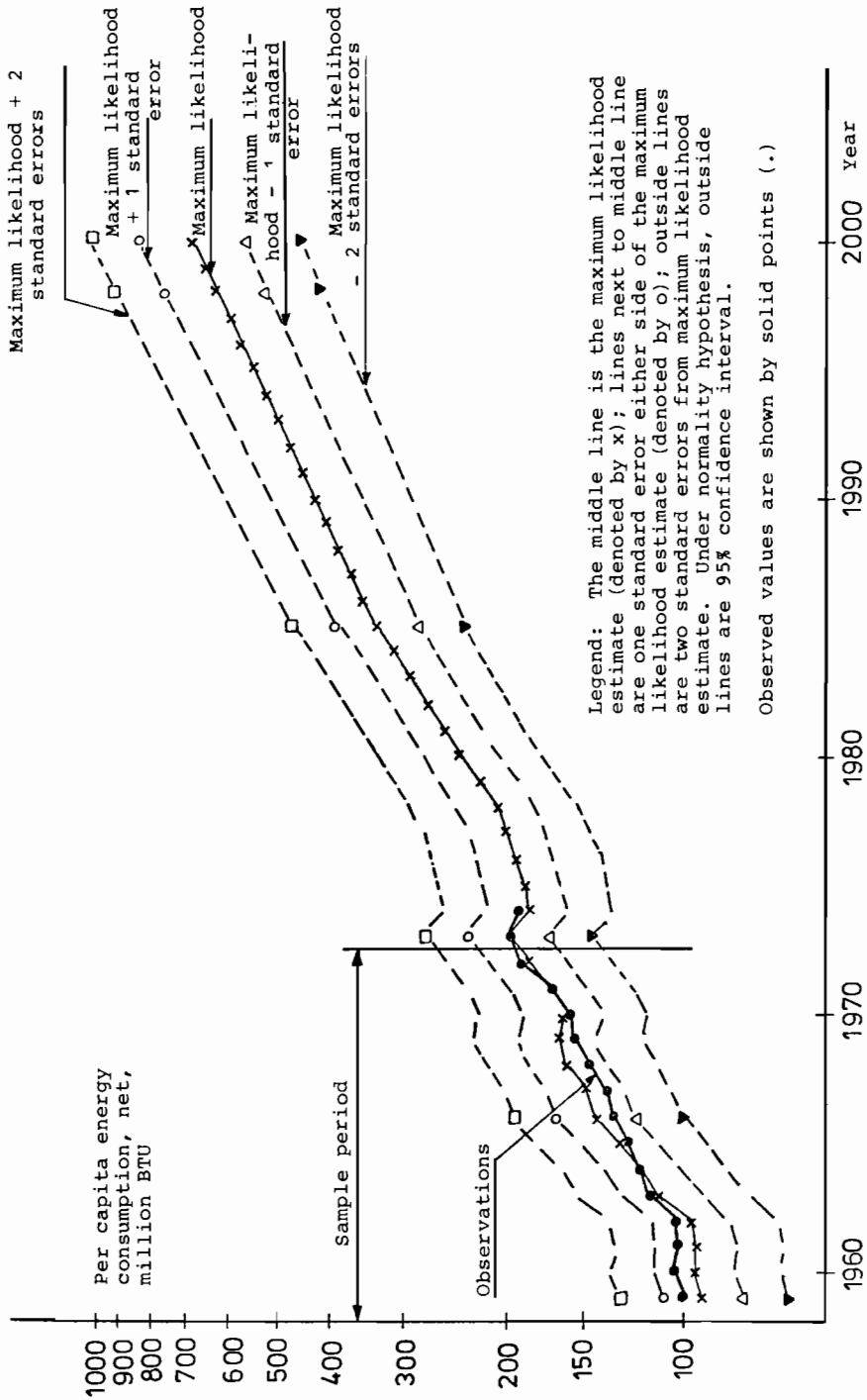

Figure 8. Maximum likelihood path for 50% erosion, and likelihood contours one and two standard errors beyond maximum likelihood estimate, United States, 1959 to 2000, and observed values 1959-1974.

should be relatively moderate growth of energy demand over the period 1972 to 1980; in the constant 1974 price case, the growth in energy demand is fairly flat from 1972 to 1978, but accelerates after that. Note as well that there are quite significant differences between the extreme paths by the end of the century. In particular, the historical path shows rapid growth in demand, averaging about 3.2% per annum once the effect of the events of 1970 to 1974 have disappeared, while the growth rate for the constant 1974 price path shows a growth rate of 2.2% per annum, one full percentage point slower.

It can be seen that two different sources of uncertainty are contained in our projections. First, there is the uncertainty in the evolution of prices, as reflected in the four different relative price paths. And second there is the inherent uncertainty of the projections due to the uncertainty of the values of the elasticities. Figure 7 shows that the uncertainty about the path due to the evolution of prices is not terribly great in the immediate future (note that the historical price series assumes that the events of the last five years did not take place), but this uncertainty compounds with time until the end of the century when it amounts to a difference of 57% between the extreme paths. The other uncertainty involves the uncertainty of the parameters, shown in Table 10. This uncertainty is of the same order of magnitude as that for price. If we assume that by the end of the century the initial conditions have damped out, then the 67% uncertainty range is 41% between the maximum likelihood plus and minus one standard error. It must be stressed that these are uncertainties which are inherent in the problem and cannot be resolved within the methodological framework used here. It is conjectured that they are also realistic reflections of the real uncertainties that we face in planning.

VII. Summary and Conclusions

The present paper reports on the preliminary results of a study of energy demand from an international perspective. The major differences between this study and earlier studies were: a) from a theoretical point of view, it attempts to estimate the demand for net energy in four major sectors of the economy, without regard at this stage to the breakdown between the different fuels; b) that it attempts to compare the energy demand functions of seven different Western countries over the period 1955-1972, both in individual estimates and by pooling the data.

The results of the study are somewhat mixed. On an individual country level, the regression results show considerable lack of precision, as well as a certain number of contradictory conclusions. It was surmised from these results that it is extremely difficult even from a time period as long as twenty years to get reliable estimates of energy demand functions from the specification used in the present paper.

When the seven countries are pooled (with country dummy variables) the results are more encouraging. First, the price elasticities are all of the correct sign (negative) and inelastic (that is, less than one in absolute value). They indicate a moderate but slow reaction of energy demand to the price of energy products. The major surprise was that the income elasticity of energy demand tends to be relatively low. In three of the four sectors (energy, industry except energy, and domestic) the estimated income elasticities were between zero and one, indicating that with relative prices of energy to other goods constant, per capita net energy demand tends to grow slower than per capita income.

A second important conclusion is that the net energy consumption of the aggregate economies, as well as different sectors, is relatively well-explained by population, per capita income, and relative prices. Without dummy variables, between 60% and 96% of the sample's variance is explained by these

factors, while country dummy variables raise the explanatory power to 95% to 99% of the variance.

Moreover, it appears that relative prices play a crucial role in determining the energy intensiveness across space and time. With no exceptions the price elasticities stand out quite clearly in the pooled results.

In a final set of regressions, countries were pooled without allowing for individual country effects. These results confirm the results with dummy variables except for transport --where the price elasticity is dramatically higher--and energy--where the income elasticity is much higher.

At the end, very preliminary projections were made for the United States using the results of the regressions as well as possible price paths. The projections indicate that the recent rise in energy prices should have a substantial effect on the growth of energy consumption for the period until about 1980, but that after 1980 the growth rate in energy consumption would be about the same--perhaps a percentage point higher, perhaps a point lower--as the path without the dramatic price changes of the 1970-1975 period. Emphasis was placed on the uncertainty of these results, both because of the uncertainties about the elasticities and because of the uncertainties about price and income trends. The statistical uncertainty of the projections was presented, and it was concluded that the size of the uncertainty about demand at the end of the century was about equally due to the uncertainty about price and income and to the uncertainty about the structure of the equation.

To conclude on a more general note, we have learned a great deal about the structure of energy demand within and across different countries. These results can be used to sharpen forecasts and to complement energy supply models, but they are plagued by unsolved problems, problematical data, and uncertain estimates. Perhaps in the end we will find that the limits to knowledge about the future are greater than the limits to growth in the future.

APPENDIX

1. The composite statistic is calculated as follows. We assume that the coefficients of the country equations are drawn from populations with a common mean μ and different variances σ_i^2 . If we desire to make the usual significance tests we further assume that the distribution is normal. We find a set of weights (a_1, \dots, a_n) , and a composite statistic $M = \sum a_i m_i$, $\sum a_i = 1$, where the $\{a_i\}$ are chosen to minimize the variance of the composite statistic. Thus we choose $\{a_i\}$ to

$$\begin{aligned} \text{minimize } \sigma^2(M) &= \sum a_i^2 \sigma_i^2 \\ \text{subject to } &\sum a_i = 1 \end{aligned}$$

and where

$$M = \sum a_i m_i \quad .$$

Maximization shows that

$$a_i = c \sigma_i^{-2}$$

where

$$c = \frac{1}{\sum \sigma_i^{-2}} \quad .$$

So our composite statistics are

$$M = \frac{\sum m_i \sigma_i^{-2}}{\sum \sigma_i^{-2}} \quad (19)$$

$$\sigma^2(M) = \frac{\sum \sigma_i^2 \sigma_i^{-2}}{\sum \sigma_i^{-2}} = \frac{n}{\sum \sigma_i^{-2}} \quad . \quad (20)$$

2. The calculation of standard errors for the long-run elasticities for the Koyck or geometrical lag is complicated by the non-linearity. In specification (A), the relevant standard errors are $\sigma\left(\frac{a_1}{1-a_3}\right)$ or $\sigma\left(\frac{a_2}{1-a_3}\right)$. Following Champernowne [13] we calculate a local standard error as:

$$\left(\frac{E\left(\frac{a_1}{1-a_3}\right)}{\sigma\left(\frac{a_1}{1-a_3}\right)}\right)^{-2} = \left(\frac{E(a_1)}{a_1}\right)^{-2} + \left(\frac{E(1-a_3)}{\sigma(1-a_3)}\right)^{-2} \quad (21)$$

Since all coefficients except the denominator of the left hand side are known, we can calculate the local standard error from (A3). A proof is given in Champernowne [13] (p. 155 f.). Note that this calculation assumes independence of the estimates of a_1 and a_3 .

3. In the estimate of the Durbin-Watson statistic for the pooled sample with n countries we have $(n-1)$ jumps which are due to the pooling. Assume the correct structure is

$$u_{t,i} = \rho u_{t-1,i} + \epsilon_{t,i}$$

where $\epsilon_{t,i}$ is drawn from a population with mean zero, equal variances for all countries, and independence of successive errors. Then it is easily verified that

$$u_{t,i} = \sum_{\theta=0}^{\infty} \rho^{\theta} \epsilon_{t-\theta,i} \quad .$$

Further note that $E(u_{t,i}, u_{v,j})$ is 0 for all t, v and $i \neq j$. Thus if the index w runs over "program periods," $w = 1, \dots, W$, we have

$$D.W. = \frac{\sum (u_w - u_{w-1})^2}{\sum u_w^2}$$

$$E(D.W.) = \left(\frac{W-1}{W} \right) \left[2 - 2 \frac{(W-n+1)\rho}{W} \right].$$

To calculate the corrected Durbin-Watson statistic we use the fact that the corrected Durbin-Watson, \bar{d} , is related to the calculated Durbin-Watson, \hat{d} , by:

$$\bar{d} = \left(\frac{W-1}{W-n+1} \right) \left[2 \left(\frac{W-n+1}{W} \right) - 2 + \frac{\hat{d} W}{W-1} \right].$$

Note that for seventy-six observations and two exogenous variables the lower and upper limits on the Durbin-Watson statistics are 1.55 and 1.66, respectively (see Durbin and Watson [23]).

References

- [1] Adelman, M.A. "Is the Oil Shortage Real?" Foreign Policy, 9 (Winter 1972), 69-107.
- [2] Adelman, M.A. The World Petroleum Market. Johns Hopkins University Press, 1972.
- [3] Almon, C., Buckler, M.R., Horwitz, L.M., and Reinhold, T.C. 1985: Interindustry Forecasts of the American Economy. Lexington, Massachusetts, 1974.
- [4] Almon, S. "The Distributed Lag Between Capital Appropriations and Expenditures." Econometrica. (January, 1965).
- [5] Anderson, K. "Residential Demand for Electricity: Econometric Estimates for California and the U.S." Rand Corporation, R-905-NSF, January 1972.
- [6] Associated Universities, Inc. Reference Energy Systems and Resource Data for Use in the Assessment of Energy Technologies. Associated Universities, 1972.
- [7] Balassa, Bela. "Purchasing Power Parity." The Journal of Political Economy (June 1964).
- [8] Berndt, E.R., and Wood, D.W. "Technology, Prices and the Derived Demand for Energy." Discussion Paper 74-09, University of British Columbia, May 1974.
- [9] Bonner and Moore Associates. "U.S. Motor Gasoline Economies." Washington, D.C., American Petroleum Institute, 1967.
- [10] Bradley, P.G. The Economics of Crude Petroleum Production. Amsterdam, 1967.
- [11] Breyer, S., and MacAvoy, P.W. "Energy Regulation by the Federal Power Commission." Washington, D.C., The Brookings Institution, 1973.
- [12] Burrows, J.C., and Domencich, T. An Analysis of the United States Oil Import Quota. Lexington, Massachusetts, 1970.
- [13] Champenowne, D. Uncertainty and Estimation in Economics. Volume 2. Edinburgh, Oliver and Boyd, 1969.

- [14] Chapman, D., Mount, T., and Tyrell, T., "Electricity Growth: Implications for Research and Development." Testimony before the Committee on Science for Astronautics, U.S. House of Representatives, June 16, 1972. (See also Mount [47].)
- [15] Chenery, Hollis. "Restructuring the World Economy." Foreign Affairs (January 1975).
- [16] Cicchetti, C., and Goldsmith, O.S. "Oil and Gas: A Case Study of Institutional Irrationality." American Journal of Agricultural Economics (1974).
- [17] Data Resources Inc. The Energy Balance Model: A Preliminary Report. Lexington, Massachusetts, November 1972.
- [18] De Chazeau, M.G., and Khan, A.E. Integration and Competition in the Petroleum Industry. New Haven, Yale University Press, 1959.
- [19] Denison, E. Why Growth Rates Differ. Washington, D.C. The Brookings Institution, 1967.
- [20] Dhrymes, P. Distributed Lags. Holden-Day, 1971.
- [21] Duchesneau, T.D. "Interfuel Substitutability in the Electric Utility Sector of the U.S. Economy." Economic Report to the Federal Trade Commission, February 1972.
- [22] Dupree, W., and West, R. United States Energy through 2000. Washington, D.C., U.S. Department of Interior, 1972.
- [23] Durbin, J., and Watson, G.S. "Testing for Serial Correlation in Least Squares Regression." Biometrika (December 1950, June 1951).
- [24] Edison Electric Institute. Statistical Yearbook of the Electric Utility Industry. New York, Edison Electric Institute.
- [25] Fisher, F.M., and Kaysen, C.A. A Study in Econometrics: The Demand for Electricity in the United States. Amsterdam, 1962.
- [26] Gordon, L.R. The Evolution of Energy Policy in Western Europe: The Reluctant Retreat from Coal. 1970.
- [27] Griffin, J.M. "The Effects of Higher Prices on Electric Consumption." Bell Journal of Economics and Management Science, 5 (1974), 515-539.

- [28] Gunning, J.W., Osterrioth, M., and Walbroeck, J. "The Price of Energy and Potential Growth of Developed Countries." Unpublished manuscript, IBRD, 1975.
- [29] Haefele, W., and Manne, A. "Strategies for a Transition from Fossil to Nuclear Fuels." IIASA RR-74-1. Laxenburg, Austria, International Institute for Applied Systems Analysis, 1974.
- [30] Hoel, Paul G. Introduction to Mathematical Statistics. Fourth Edition. New York, Wiley, 1971.
- [31] Hottel, H.C., and Howard, J.B. New Energy Technology: Some Facts and Assesments. Cambridge, Massachusetts, MIT Press, 1971.
- [32] Houthakker, H., Verleger, P., and Sheehan, D. "Dynamic Demand Analysis for Gasoline and Residential Electricity." American Journal of Agricultural Economics (1974).
- [33] Hudson, E.A., and Jorgenson, D.W. "U.S. Energy Policy and Economic Growth, 1975-2000." Bell Journal of Economics and Management Science, 5 (1974), 461-514.
- [34] Hudson, E.A., and Jorgenson, D.W. "Tax Policy and Energy Conservation." Testimony before the Committee on the Finance, Washington, D.C., U.S. Senate, January 16, 1974.
- [35] Jorgenson, D.W., Berndt, E.R., Christensen, L.R., and Hudson, E.A. U.S. Energy Resources and Economic Growth. Washington, D.C., Final Report to the Energy Policy Project, September 1973.
- [36] Jorgenson, D.W. "Consumer Demand for Energy." Discussion Paper No. 386, Harvard Institute for Economic Research, Harvard University, November 1974.
- [37] Keenan, J.H. "The Fuel Shortage and Thermodynamics--The Entropy Crisis." American Journal of Agricultural Economics (1974).
- [38] Kendrick, J., and Sato, K. "Economic Growth." American Economic Review (December 1960).
- [39] Koopmans, T.C. "Notes on Elasticities." Unpublished memorandum, Laxenburg, Austria, 1974.
- [40] Koyck, L.M. Distributed Lags and Investment Analysis. North-Holland, 1954.
- [41] Krugman, Paul. "The Demand for Gasoline." Unpublished memorandum, New Haven, 1974.

- [42] Lyon, W.H., and Colby, D.S. "Production, Consumption, and Use of Fuels and Electric Energy in the United States in 1929, 1939, and 1947." Report of Investigations 4805, U.S. Bureau of Mines, 1951.
- [43] MacAvoy, P.W. Economic Strategy for Developing Nuclear Breeder Reactors. Cambridge, Massachusetts, 1969.
- [44] Macrakis, M.S. Ed. Energy: Demand, Conservation, and Institutional Problems. Cambridge, Massachusetts, 1974.
- [45] Malinvaud, E. Statistical Methods of Econometrics. Chicago, Rand McNally, 1966.
- [46] McDonald, L.S. Petroleum Conservation in the United States: An Economic Analysis. Baltimore, Johns Hopkins University Press, 1971.
- [47] Mount, T.D., Chapman, L.D., and Tyrell, T.J. "Electricity Demand in the United States." Oak Ridge National Laboratory, June 1973.
- [48] National Petroleum Council. U.S. Energy Outlook: An Initial Appraisal 1971-1985. Washington, D.C., July 1971.
- [49] Nordhaus, W.D. "The Allocation of Energy Resources." Brookings Papers on Economic Activity, 3 (1973).
- [50] OECD. Energy Policy: Problems and Objectives. Paris, 1966.
- [51] OECD. Energy Prospects to 1985. Paris, 1974.
- [52] Pindyck, R.S. "Market Structure and Regulation: The Natural Gas Industry." American Journal of Agricultural Economics (1974).
- [53] Platt's Oil Price Handbook. 1973.
- [54] Schurr, S.H. et al. Middle East Oil and Western World. New York, 1971.
- [55] Searl, M.C. Ed. Energy Modelling. Washington, D.C., 1971.
- [56] Seitz, W.D. "Productive Efficiency with Steam Electric Generating Industry." Journal of Political Economy, 79 (1971), 878-886.
- [57] Shepard, W. Duality in Production Theory. Princeton, 1960.
- [58] Steele, H. "Hearings on Government Intervention in the Market Mechanism: The Petroleum Industry." Testimony before the Judiciary Committee, Washington, D.C., U.S. Senate, 1969.

- [59] Stocking, G.W. Middle East Oil. Kingsport, Vanderbilt University Press, 1970.
- [60] Summers, C.M. "The Conversion of Energy." Scientific American (September 1971), 149-160.
- [61] Taylor, L. The Demand for Electricity: A Survey. Palo Alto, Electric Power Research Institute, June 1974.
- [62] Tsvetanov, P., and Nordhaus, W. "Problems in Energy Demand Analysis." In W.D. Nordhaus, Ed. Workshop on Energy Demand. IIASA CP-75-5. Laxenburg, Austria, International Institute for Applied Systems Analysis, 1975.
- [63] U.S. Bureau of Mines. Minerals Yearbook. United States Government Printing Office.
- [64] U.S. Cabinet Task Force on Oil Import Control. "The Oil Import Question." Washington, D.C., United States Government Printing Office, 1970.
- [65] U.S. Congress. "Investigation of the Petroleum Industry." Washington, D.C., United States Government Printing Office, 1973.
- [66] U.S. Federal Energy Administration. "Project Independence." 1974.
- [67] U.S. Federal Power Commission. "The 1970 National Power Survey." Washington, D.C., December 1971.
- [68] Uzawa, H. "Note on Elasticities." Unpublished memorandum, Laxenburg, Austria, 1974.
- [69] Wellisz, S.H. "Regulation of Natural Gas Pipeline Companies: An Economic Analysis." Journal of Political Economy, 71 (1963), 30-43.
- [70] Wilson, J.W. "Residential Demand for Electricity." Quarterly Review of Economics and Business, 2 (1971), 7-22.

Discussion

Waverman

I want to ask Nordhaus if, in running a cross-section time series with Italy and the United States, you are sure you separated the regional from the interregional effects?

Nordhaus

The main procedure I used was to separate them out by using country dummy variables. Later on you can then perform the heroic aggregation of lumping countries together and removing the country dummy variable. With two exceptions, transport price elasticity and energy income elasticity, the results are very similar. With these exceptions we have come to the point where we can explain a good part of the cross-country differences in energy consumption in the four sectors by price, income, and climate.

Parikh

I have a question for Nordhaus. These results for transport were rather surprising. Perhaps the income and price elasticities are mixed up. I was wondering if you considered the possibility that poor people in many countries travel more because they live in the periphery of cities and the rich live in the central part and travel less. Can you sort out some of the details and improve your results?

Nordhaus

There are surely serious errors in measurement of data, but you can see a lot of daylight between price and the income. They are not collinear when you pool the data, so you get quite a sharp determination. Thus, I rather think that either transport demand is very price inelastic or else there are very serious errors of measurement. To supplement this, I could report for a single year

in which we asked whether the very heavy road taxes imposed in Western Europe--through gasoline prices and also automobile taxes--were able to shift transport demand out of the road sector into the rail sector. We could not find any effect. The share of energy consumption in road traffic is completely uncorrelated with the relative price differences. And the relative price differences were a factor of about two. So that is another independent observation that makes me think that demand is very inelastic. Finally, recall that when country variables are omitted considerable price elasticity shows up. I do not know how to reconcile these three pieces of information.

Energy Prospects in the Organization for Economic
Cooperation and Development Area to 1985

R. Hamilton

This paper reports on a study of energy supply and demand carried out by the Secretariat of the Organization for Economic Cooperation and Development during 1973-74 as part of the Long Term Energy Assessment. The assessment was prepared by a central unit under the guidance of Hans K. Schneider, Director General of the Institute for Energy Economics of the University of Cologne,¹ and benefitted from contributions of various committees of the OECD and of member country governments. The overall results were published in January 1975 in a two volume report entitled Energy Prospects to 1985. The following discussion is based on that report.

The Basic Approach

Until recently, forecasts of energy demand relied heavily on what appeared to be a stable relationship between energy consumption and GDP. As a result of the spectacular increases in international oil prices since 1973, however, it is no longer possible to ignore their influence. In the OECD study an attempt was made to measure price effects on both consumption and production by making several alternative energy projections corresponding to different sets of energy prices.

Another reason for making alternative projections is the uncertainty which prevailed during 1974 concerning

¹Other members of the central unit were: L.W. Boxer, W. Czerniejewicz, R.E. Hamilton, A. Mittelstädt, P. Van den Berg and I.M. Torrens.

the future course of oil prices. Because of this uncertainty it was felt that a "most probable" forecast would be even less reliable than those made in the past. None of the OECD projects is identified as a "most probable" one. They are hypothetical in nature and are aimed at providing a framework for investigating possible future developments and identifying problems which might confront policy makers.

Since several projections are presented based on different price sets it might be thought desirable to provide alternative projections based on different assumptions with respect to the growth of the GNP. This exercise was not carried out in full detail, but an attempt was made to examine the sensitivity of the demand estimates to small changes in GNP, and the results are reported below.

Methodology

Three sets of energy balances were estimated for the years 1980 and 1985 for each of the following countries and regions: the United States, Canada, OECD Europe, the EEC, and Japan. They include:

- 1) a set of base projections relying to a large extent on forecasts constructed by member country governments and corresponding to the energy situation prior to October, 1973;
- 2) a set of projections corresponding to a price of \$6 (in constant 1972 US dollars) per barrel of Arabian API 34⁰ crude oil FOB at the Persian Gulf; and
- 3) a set of projections corresponding to a crude oil price of \$9.

In addition, one set of energy balances was constructed for 1980 and 1985 for each of Australia and New Zealand. The

Australian projections are based on the energy situation prior to October 1973, while the New Zealand forecasts pertain to a situation in which oil prices remain at their early 1974 levels.

The alternative \$6 and \$9 cases were chosen because it was felt that these two prices provided reasonable boundaries within which actual 1980 and 1985 prices are likely to be situated. In terms of 1974 prices the corresponding values are \$7.20 and \$10.80. The average price presently being paid for Arabian oil falls within this range.

The \$6 and \$9 projections were derived from the base case using the following procedures:

- a) Prices were estimated for the various forms of energy used in OECD countries for each of the three cases.
- b) Demand elasticities were used to determine the reduction in the quantity of energy demanded in response to higher prices compared to the base case. Estimates were made for the quantity of each type of energy expected to be produced in \$6 and \$9 cases. Supply elasticities were not used directly.
- c) Adjustments were made in the allocation of different forms of energy among consuming sectors in order to satisfy various technical and policy constraints. For each region imports and exports of forms of energy other than oil were limited to amounts judged to be feasible. Efforts were made to ensure consistency between exports from exporting regions and imports into importing regions.
- d) Oil imports were derived mainly as residuals.

The base projections were derived largely from member country forecasts.² The most important feature of these projections is that either they do not take explicit account of prices at all or they are based on price expectations which prevailed before October 1973.

GDP Assumptions

The GDP growth rates incorporated in all three sets of projections are those which underlie the base projections. They are summarized in Table 1.

Table 1. OECD Country or regional GDP growth rates 1971-85, incorporated in the projections.

| | <u>1971-80</u> | <u>1980-85</u> |
|-------------------|----------------|----------------|
| USA | 4.3 | 4.0 |
| Canada | 4.7 | 4.7 |
| EEC | 5.2 | 4.8 |
| Other OECD Europe | 5.1 | 5.2 |
| Japan | 8.1 | 7.4 |
| Australia | 5.0 | 5.0 |
| New Zealand | 4.5 | 4.5 |

Two difficulties arise concerning the use of these growth rates. First, the price differences between the three cases are of such magnitude that it may not be appropriate to

²For the United States estimates have been supplied by the Federal Energy Administration, for Canada by the Department of Energy, Mines and Resources, and for the EEC information was made available to the Secretariat by the Commission of the European Communities. For other OECD Europe, the Secretariat has made estimates. For Japan estimates are from "Japan's Energy Problems" (Japan, the Institute of Energy Economics, August 1973). For Australia and New Zealand, estimates have been supplied by the governments of these two countries.

assume the same GDP growth rate in all three cases. A better solution might have been to associate lower GDP's with the \$6 and \$9 cases than with the base case.

The second difficulty is that these GDP estimates are largely based on expectations held prior to 1974 and may not reflect views since then. More recent predictions may differ from those made earlier not only because of the oil price increases but for other reasons as well. Current estimates of 1980 GDP's tend to be lower than those made prior to 1974. Both of these difficulties suggest that, *ceteris paribus*, the \$6 and \$9 projections of consumption are likely to be biased upward in comparison with the base case projections.

Estimating of Prices

The estimation of energy prices for each of the three cases for 1980 and 1985 involved the following steps:

- 1) A crude oil price at the Persian Gulf was selected.
- 2) Estimates were made of tanker rates from the Persian Gulf to the various OECD countries and regions. The first two steps yielded estimates of CIF prices.
- 3) Retail prices for the various oil products were calculated by adding to (or subtracting from) the CIF prices constant absolute margins based on those which existed in 1972.
- 4) Gas and coal prices were determined by relationship to oil prices in markets in which these fuels are expected to compete with oil. There were, however, some exceptions, as described below.
- 5) Electricity prices were estimated by assuming the same absolute differences between rates to different categories of consumers as existed in 1972 but adjusting the levels in accordance with changes in prices of fuels used to generate electricity.

All prices are in constant 1972 US dollars.

The selection of 1980 and 1985 prices to associate with the base projections proved to be a problem, since the original-country forecast documents provided only scanty information concerning price expectations. Different approaches were followed for different countries and regions. Since the Japanese projections appeared to assume no rise in energy prices relative to general prices, the 1972 energy prices, corresponding to a Persian Gulf crude oil price of \$1.75 per barrel, were those chosen to associate with the base projections for 1980 and 1985. Price sets were chosen for Europe and the United States for 1980 which correspond to a Persian Gulf crude oil price of \$3 per barrel. The price set chosen for Canada corresponds to a Persian Gulf crude oil price of \$3.50. Somewhat higher prices were chosen for the United States and Canada for 1985. It is believed that possible errors made in the choice of prices for the base projections are biased toward prices which are too high, thus producing underestimates of price differences between the base case and the \$6 and \$9 cases.

In all countries or regions except Canada domestic well-head crude oil prices were set equal to CIF import prices. Canadian well-head prices were determined at levels such that the price of Canadian crude delivered to Montreal would equate with the price of imported crude there.

Gas and coal prices for Europe and Japan were related to (in most cases set equal to) oil prices in terms of heat value in markets in which those fuels are expected to compete with oil. This procedure determined all coal and gas prices except for coking coal prices, which were selected on the basis of their relationship to other coal prices in 1972. Gas and coal field prices for the United States were set at levels needed to generate the supply

estimates (which are discussed below) for these fuels. Retail prices were then calculated by adding the same constant margins as existed in 1972.

Retail prices for coal consumed in Canada were linked to United States prices at levels determined by the differential that existed in 1972. Retail gas prices for Canada were determined by setting city gate prices in the Great Lakes area equal to delivered crude oil prices and then adding to the city gate prices the same margins as existed in 1972.

This is a relatively crude approach toward estimating price structures to associate with the various cases. However, given the uncertainties surrounding practically every aspect of the 1980 and 1985 energy projections it is doubtful if a more sophisticated approach would yield significantly more reliable predictions of overall energy quantities. But several shortcomings of the present approach should be noted. The assumption of constant absolute margins between retail prices and producers' prices is not correct for all countries and forms of energy. Some countries, for example, have value-based taxes which would cause margins to increase as Persian Gulf prices increase. In addition, competitive pressures would cause some retail oil prices to increase by more than the FOB price increases, while others would increase less. In general, it is likely that the use of constant absolute margins results in some underestimating of price differences between the base cases and the \$6 and \$9 cases. Another difficulty arises from the use of average prices for large regions such as Europe, the United States and Canada within which prices vary substantially among localities.

Demand Elasticities

In order to derive \$6 and \$9 energy consumption estimates, elasticity coefficients for the response of quantity demanded to price were applied to all sectors of final consumption, and to the consumption of fossil fuels in generating electricity.³ The elasticity coefficients used in the OECD study measure the response of total energy consumed in each sector resulting from an increase in the weighted average fuel price for that sector. The exceptions to this approach concern gasoline and energy sector consumption, for which separate elasticities for each fuel were used on the assumption that the prices of other forms of energy are not significant variables in its demand function. A problem arose with respect to the elasticity applied to non-energy oil consumption. Since gas may be used as a substitute for oil as a petrochemical feedstock the price of gas, as well as the price of oil, probably affects the quantity of oil demanded for non-energy purposes. This consideration was taken account of in several cases by substituting industrial gas consumption for a portion of non-energy oil consumption.

The elasticities were not derived by econometric means but were selected on the basis of judgment after examining existing econometric studies and investigating engineering and other analyses of potential energy savings in individual

³Given the quantity q_1 in the base projection demanded at a price p_1 and the elasticity α , the quantity q_2 which would be demanded at a price p_2 is obtained by means of the equation:

$$q_2 = q_1 \left(\frac{p_2}{p_1} \right)^{-\alpha} .$$

consuming sectors.⁴ They are considered to be long run coefficients, implying that the relevant prices are expected by consumers sufficiently far in advance for them to make long run adjustments. Even so, some of the coefficients used for 1980 are less than the corresponding figures for 1985. For the price changes incorporated in the present cases they yield demand reductions that are significantly less than the energy savings considered feasible by conservation specialists. The elasticity coefficients are shown in Table 2.

Table 2. Demand elasticities for 1980 and 1985.

| | | United States | Canada | Europe | Japan |
|--|------|------------------|--------|--------|-------|
| Residential/Commercial | 1980 | 0.2 | 0.2 | 0.2 | 0.3 |
| | 1985 | 0.3 | 0.3 | 0.3 | 0.4 |
| Industrial | 1980 | 0.3 | 0.3 | 0.3 | 0.2 |
| | 1985 | 0.4 | 0.4 | 0.3 | 0.3 |
| Transportation - Gasoline | 1980 | 0.3 | 0.3 | 0.3 | 0.4 |
| | 1985 | 0.5 | 0.4 | 0.4 | 0.4 |
| Transportation - Other Fuels | 1980 | 0.2 | 0.2 | 0.2 | 0.4 |
| | 1985 | 0.4 | 0.3 | 0.2 | 0.4 |
| Non-Energy Oil | 1980 | 0.1 | 0.1 | 0.1 | 0.1 |
| | 1985 | 0.1 | 0.1 | 0.1 | 0.1 |
| Energy Sector - Oil | 1980 | 0.25 | 0.25 | 0.23 | 0.25 |
| | 1985 | 0.3 | 0.3 | 0.23 | 0.25 |
| Energy Sector - Other | | zero | zero | zero | zero |
| Fossil Fuels in Electric Generation | 1980 | zero | zero | 0.1 | zero |
| | 1985 | 0.12 | 0.12 | 0.1 | zero |

⁴When the OECD study was being prepared few published estimates of the type desired existed. One source which proved valuable and which does provide a comprehensive set of elasticity coefficients is a document written as an appendix for the National Petroleum Council's United States Energy Outlook (December 1972).

Substitution Among Energy Products

Since most of the demand elasticities are applicable to total energy consumption in particular sectors, they provide no method for calculating the amount of each particular form of energy consumed in a sector. One solution to this problem would be to make use of demand functions in which the quantity demanded of each energy product depends on its own price and the prices of competitive or complementary energy forms. Available studies based on this approach were few, and frequently the cross-elasticity coefficient in the equation for a given energy product was found to be inconsistent with the coefficients in equations for other energy products, particularly in cases where the different equations were estimated by different investigators. For these reasons this approach was not followed. Instead, allocations of individual energy products were based on judgments influenced by such factors as relative prices of various forms of energy, difficulties of switching among fuel burning facilities, and environmental controls over fuels used. There were also certain constraints introduced on the supply side. For example, for Europe and Japan, imports of natural gas as well as indigenous supplies were estimated independently of the demand side. These estimates fixed the total amount of gas available for consumption in each of those two regions and thereby acted as a constraint on gas consumption in individual sectors.

It is important to note that errors made in estimating substitution among energy products do not affect total amounts of energy consumed, imported or exported. They affect only the particular forms in which energy is consumed and traded. If, for example, the potential for substitution of natural gas in place of oil in a particular region was overestimated the chief consequences would be an overestimate of gas imports and an exactly equivalent underestimate of oil imports.

The demand estimates may entail some double counting in countries or regions in which energy production is significantly larger in the \$6 and \$9 cases than in the base case. The increased energy production would entail some additional energy sector consumption, *ceteris paribus*. However, since total economic output is assumed to be the same in all three cases, the increased energy production should be offset by reduced economic production elsewhere and the increased energy sector energy consumption should be accompanied by some, though not necessarily equal, decrease in energy consumption in other sectors. No adjustment was made to deal with this problem.

Supply Estimates

Most of the estimates of supply of primary energy for the various cases are those submitted to the Ad Hoc Group of the OECD Oil Committee in Spring 1974 by member country governments. There are, however, some exceptions. The estimates of US coal production in the \$6 and \$9 cases were fixed lower than the quantities considered possible by the United States authorities because markets could not be found for the additional production. The estimates for European oil and gas production for the \$6 and \$9 cases were set higher than the estimates given to the Ad Hoc Group on the basis of evidence from industry made available during the 1973-74 period. Estimates for nuclear power production were set lower than some governments would consider as targets on grounds that the achievement of these targets would require special efforts that go beyond the response induced by the price changes assumed in the projections.

Future consumption and hence production of electricity will be influenced by two opposing forces. On the one hand, higher electricity prices will tend to discourage electricity consumption, while on the other hand, higher prices for

competing energy products will tend to induce some substitution of electricity for these products. Because of these opposing forces it was felt that electricity production would differ very little among the three cases. In the OECD projections it is higher in the \$6 and \$9 projections than in the base cases for Europe and Canada but is lower in the rest of the OECD area.

Imports of natural gas into Europe and Japan were estimated largely on the basis of already established contracts together with those being presently discussed. Gas import into the United States were set approximately equal to gas exports available from Canada in the \$9 cases for 1980 and 1985. In the \$6 cases provision was made for imports from other countries as well as Canada. Gas exports from Canada were set equal to presently licensed quantities for the base and the \$6 cases for 1980, but in the other cases for 1980 and 1985 they were estimated as surpluses obtained by subtracting from indigenous supplies the amounts which could be absorbed domestically taking account of possibilities of substitution for oil.

Coal imports into Europe and Japan were determined as residuals by deducting indigenous supplies from consumption. Coal exports from Canada were calculated by deducting domestic consumption from indigenous supplies. Coal exports from the United States were calculated in the same way with the exception of the \$9 case in 1985 where exports were limited approximately to amounts which could be absorbed within the OECD area. Oil imports into (or exports from) individual OECD regions were calculated as the algebraic differences between consumption and production.

General Policy Assumptions

The \$6 and \$9 projections were designed to show the adjustments in energy consumption and production in comparison

with the base case which would be attributable to price changes alone. In some cases, however, it was not possible to separate price effects from the consequences of government policies. Hence a brief discussion of the main policy assumptions is provided here.

Since the estimation of oil prices associated with the three sets of projections assumed constant absolute margins between CIP import prices and prices to final consumers, the projections implicitly incorporate tax and price policies which allow these margins to hold constant while still permitting prices to rise in absolute terms by the amounts by which oil import prices rise. Similarly, the projections assume policies which allow the continuation of the same absolute margins between retail prices and producers' prices of other forms of energy. No explicit provision was made for the introduction of special conservation measures such as lower speed limits for automobiles, taxes on large cars, stricter insulation requirements for buildings, etc.

Domestic well-head oil prices were allowed to rise to levels determined by oil import prices (as given by hypothesis in the \$6 and \$9 cases) plus the tariffs in existence at the time the study was made. Producers' prices for most other fuels were assumed to be allowed to move to levels determined by competitive relationships with oil prices. One exception to this general approach concerns US gas field prices, which were assumed to be set by regulation at \$.30 per thousand cubic feet, \$.41 and \$.63, respectively in the base, \$6 and \$9 cases for both 1980 and 1985. It was assumed that income and other taxes would not counteract the incentives provided to producers by higher prices.

The production estimates which are taken from member country submissions to the Ad Hoc Group of the Oil Committee incorporate the national policy assumptions associated with these estimates. In the \$9 cases for the United States these

policies include measures such as the opening up of naval reserves of oil, accelerated leasing of off-shore areas, and special efforts to develop oil shale, which may go beyond the response that might ordinarily be attributed to price effects alone. The estimates for North Sea oil production in the Norwegian sector take account of government-set target rates of production which are thought to be lower than potential rates. However, as mentioned above, estimates for nuclear power production incorporated in the \$6 and \$9 cases were in a few instances set lower than targets sets by member country governments on grounds that special measures would be needed to achieve these targets.

That some of the policy assumptions listed here are not consistent with the aim of measuring price effects alone is partly due to the fact that considerable importance was attached to the likelihood of certain policies being adopted and maintained during the period of the projections. In some cases, therefore, certain policies were assumed in the analysis even though it was realized they might interfere in a positive or negative way with the operation of market forces.

Discussion of Regional Projections: United States

Energy balances for the United States are shown in Tables 3 to 5. Total primary requirements in 1980 in the \$6 and \$9 cases are 4.7% and 8.2% respectively below base case levels; in 1985 the corresponding figures are 7.4% and 12.4%. These estimates imply annual growth rates for energy consumption for the period 1972-85 of 3.2% in the \$6 case and 2.8% in the \$9 case, compared with 3.8% in the pre-October 1973 forecast.

Table 3. United States 1972.

| Mtoe (10 ¹³ kcal) | Coal | Oil | Gas | Electricity | Nuclear | Hydro- & Geo | Total |
|--------------------------------|-------|---------------------|-------|-------------|---------|-----------------|---------|
| Indigenous Supply | 365.4 | 560.3 | 571.6 | | 14.1 | 29.7 | 1,541.1 |
| Imported Supply (net) | -38.8 | 254.6 | 24.8 | | | | 240.6 |
| Stock Changes ¹⁾ | -13.4 | 9.9 | -9.0 | | | | -12.5 |
| TOTAL PRIMARY ENERGY | 313.2 | 824.8 | 587.4 | | 14.1 | 29.7 | 1,769.2 |
| Electricity Generation | 191.0 | 80.8 | 104.8 | -169.8 | 14.1 | 29.7 | 250.6 |
| TOTAL FINAL CONSUMPTION | 122.2 | 744.0 | 482.6 | 169.8 | | | 1,518.6 |
| Energy Sector & Losses | 15.0 | 35.7 | 28.1 | 22.2 | | | 101.0 |
| Industry | 97.3 | 50.8 | 262.2 | 64.5 | | | 474.8 |
| Transportation | 0.2 | 430.9 ²⁾ | | 0.4 | | | 431.5 |
| Residential/ Commercial | 9.7 | 140.9 | 192.3 | 82.7 | | | 425.6 |
| Non-Energy Oil | | 85.7 | | | | | 85.7 |

1) Withdrawals (+), Additions (-).

2) Includes 308.6 gasoline; 7.7 ships' bunkers.

Table 4. United States 1980.

| Mtoe (10 ¹³ kcal) | Coal | Oil | Gas | Electricity | Nuclear | Hydro & Geo | Total |
|------------------------------------|----------------------------------|---------------------------|-------------------------|----------------------------|-------------------------|----------------------|-------------------------------|
| Indigenous Supply ^{1),2)} | a) 470.0 b) 537.0 c) 537.0 | 580.9 650.0 719.0 | 496.4 541.0 613.0 | | 139.7 139.7 139.7 | 35.1 36.8 36.8 | 1,722.1 1,904.5 2,045.5 |
| Net Imported Supply | -44.6 -46.8 -64.9 | 541.9 331.2 140.8 | 138.3 58.4 42.2 | | | | 635.6 342.9 118.1 |
| TOTAL PRIMARY ENERGY | 425.4 490.2 472.1 | 1,122.8 981.2 859.8 | 634.7 599.4 655.2 | | 139.7 139.7 139.7 | 35.1 36.8 36.8 | 2,357.8 2,247.4 2,163.6 |
| Electricity Generation | 295.2 349.9 331.8 | 151.8 100.0 90.0 | 90.0 70.0 90.0 | -267.7 -263.0 -260.1 | 139.7 139.7 139.7 | 35.1 36.8 36.8 | 444.2 433.4 428.1 |
| Synthetic Fuel Consumption | 12.1 25.1 25.1 | 11.1 | -17.8 -17.8 -17.8 | | | | 5.4 7.3 7.3 |
| TOTAL FINAL CONSUMPTION | 118.1 115.3 115.3 | 959.9 881.2 769.8 | 562.5 547.2 583.0 | 267.7 263.0 260.1 | | | 1,908.2 1,806.7 1,728.2 |
| Energy Sector and Losses | 18.8 21.5 21.5 | 43.4 38.6 35.7 | 39.5 37.4 40.7 | 37.1 36.5 36.1 | | | 138.8 133.9 134.0 |
| Industry | 92.3 86.8 86.8 | 101.8 96.0 55.0 | 280.6 276.7 283.0 | 90.9 88.2 86.6 | | | 565.6 547.7 511.3 |
| Transportation | | 540.3 510.4 487.3 | | 0.8 0.8 0.8 | | | 541.1 511.2 488.1 |
| Residential/Commercial | 7.0 7.0 7.0 | 162.0 157.0 116.0 | 242.4 233.1 259.3 | 138.9 137.6 136.7 | | | 550.3 534.7 519.0 |
| Non-Energy Oil | | 112.4 79.3 75.8 | | | | | 112.4 79.3 75.8 |

1) Potential coal production in the \$9 case is as large as 650 Mtoe, but the figure used here is lower because of difficulties in finding markets. Oil from shale accounts for 2.5, 15.4 and 25.5 Mtoe, and geothermal electricity for 1.5, 3.2 and 3.2 Mtoe in the base, \$6 and \$9 cases respectively; a) = Base projection; b) = \$6 projection; c) = \$9 projection.

2) Some of the data presented here are subject to revision in the light of completion of the Project Independence Blueprint; see also footnote three of this paper.

Table 5. United States 1985.

| Mtoe (10 ¹³ kcal) | Coal | Oil | Gas | Electricity | Nuclear | Hydro & Geo | Total |
|---------------------------------------|----------------------------------|-----------------------------|-------------------------|----------------------------|-------------------------|----------------------|-------------------------------|
| Indigenous Supply ^{1),2),3)} | a) 622.4 b) 660.0 c) 660.0 | 575.4 750.0 938.0 | 462.6 583.0 623.0 | | 294.7 356.1 356.1 | 39.4 52.3 53.2 | 1,994.5 2,401.4 2,630.3 |
| Net Imported Supply | -55.5 -76.1 -91.3 | 731.0 254.6 -67.5 | 211.0 87.1 51.0 | | | | 886.5 265.6 -107.9 |
| TOTAL PRIMARY ENERGY | 566.9 583.8 568.6 | 1,306.4 1,004.6 870.5 | 673.6 670.2 674.0 | | 294.7 356.1 356.1 | 39.4 52.3 53.2 | 2,881.0 2,667.0 2,522.4 |
| Electricity Generation | 389.1 401.3 386.1 | 167.5 50.0 50.0 | 85.5 60.0 60.0 | -369.5 -363.1 -360.5 | 294.7 356.1 356.1 | 39.4 52.3 53.2 | 606.5 556.6 544.9 |
| Synthetic Fuel | 54.6 74.4 74.4 | 16.9 | -51.0 -51.0 -51.0 | | | | 20.5 23.4 23.4 |
| TOTAL FINAL CONSUMPTION | 123.2 108.2 108.2 | 1,122.0 954.6 820.5 | 639.3 661.2 665.0 | 369.5 363.1 360.5 | | | 2,234.0 2,087.0 1,954.1 |
| Energy Sector & Losses | 24.9 26.4 26.4 | 43.4 38.3 34.0 | 43.3 45.1 45.7 | 51.1 50.2 49.9 | | | 164.7 164.7 155.9 |
| Industry | 95.8 79.3 79.3 | 126.5 100.0 65.0 | 321.4 322.9 305.9 | 138.3 134.6 133.1 | | | 682.0 636.7 583.2 |
| Transportation | | 641.4 584.6 538.5 | | 0.9 0.9 0.9 | | | 642.3 585.5 539.4 |
| Residential/Commercial | 2.5 2.5 2.5 | 188.4 145.0 100.0 | 272.6 293.2 313.5 | 179.2 177.4 176.7 | | | 642.7 618.1 592.6 |
| Non-Energy Oil | | 122.3 86.8 83.0 | | | | | 122.3 86.8 83.0 |

1) Potential coal production in the \$9 case is as large as 960 Mtoe, but the figure used here is lower because of difficulties in finding markets. Oil from shale accounts for 12.6, 50.7 and 76.1 Mtoe, and geothermal electricity for 3.0, 14.3 and 14.3 Mtoe in the base, \$6 and \$9 cases respectively.

2) Solar energy is omitted, although the quantities involved, while negligible in 1980 and in the base and \$6 cases in 1985, could be as much as 100 Mtoe in the \$9 case for 1985. It could be consumed in the residential/commercial sector; a) = Base projection; b) = \$6 projection; c) = \$9 projection.

3) Since these energy balances were drawn up, the Project Independence Blueprint has been completed and published. The indigenous oil production figures therein lie in the range 650-825 Mtoe in 1985 for oil prices close to \$9/bbl, which would exclude the possibility of the United States becoming a net oil exporter by 1985.

The production estimates for oil and gas in the \$6 and \$9 cases are higher than corresponding estimates given in the Federal Energy Administration's Project Independence Report (Washington, November 1974), which was not available by the time the OECD study was completed. As a result estimates for oil imports are lower. In the \$9 case for 1980 oil imports are shown to be under three million barrels per day, while in 1985 the US is shown as exporting more than one million barrels per day in the \$9 case (presumably from Alaska to Japan).

Canada

Canadian energy balances are shown in Tables 6 to 8. Primary energy consumption falls by 6.1% below the base projection in the \$6 case in 1980 and by 9.9% in the \$9 case. The corresponding reductions for 1985 are 7.0% and 15.1% respectively. That these reductions are as large as they are is partly due to a substantial increase in the proportion of total energy requirements met by hydro-electricity, which is measured at a higher conversion efficiency than electricity generated from other forms of energy. It may be noted that the percentage declines in total final energy consumption below base case levels are smaller. The average annual growth rates in primary energy consumption between 1972 and 1985 in the three cases are 5.0%, 4.4%, and 3.7%.

Canada is shown to be a small net exporter of oil in the \$9 cases in 1980 and 1985. Some lower forecasts of supply published after the study was completed suggest that these results are too optimistic.⁵

⁵National Energy Board, Report to the Honourable Minister of Energy, Mines and Resources in the Matter of the Exportation of Oil (Ottawa, October 1974).

Table 6. Canada 1972.

| Mtoe (10 ¹³ kcal) | Coal | Oil | Gas | Electricity | Nuclear | Hydro & Geo | Total |
|--------------------------------|-------------|--------------------|-------------|-------------|------------|-------------|--------------|
| Indigenous Supply | 11.7 | 95.8 | 56.9 | | 1.9 | 19.1 | 185.6 |
| Imported Supply (net) | 7.0 | -12.8 | -24.5 | (-0.7) | | | -30.3 |
| Stock Changes ¹⁾ | -0.9 | 0.7 | | | | | -0.2 |
| TOTAL PRIMARY ENERGY | 17.8 | 83.9 | 32.4 | | 1.9 | 19.1 | 155.1 |
| Electricity Generation | 9.9 | 2.6 | 2.6 | -20.3 | 1.9 | 19.1 | 15.8 |
| TOTAL FINAL CONSUMPTION | 7.9 | 81.3 | 29.8 | 20.3 | | | 139.3 |
| Energy Sector & Losses | 1.8 | 6.2 | 3.5 | 2.1 | | | 13.6 |
| Industry | 5.6 | 10.0 | 13.1 | 9.2 | | | 37.9 |
| Transportation | | 34.3 ²⁾ | | | | | 34.3 |
| Residential/Commercial | 0.5 | 25.1 | 13.2 | 9.0 | | | 47.8 |
| Non-Energy Oil | | 5.7 | | | | | 5.7 |

¹⁾ Withdrawals (+), Additions (-).

²⁾ Includes 24.8 gasoline; 2.6 ships' bunkers.

Table 7. Canada 1980.

| Mtoe (10 ¹³ kcal) | Coal | Oil | Gas | Electricity | Nuclear | Hydro & Geo | Total |
|--------------------------------------|------|------|-------|-------------|---------|-------------|-------|
| Indigenous Supply ¹⁾ | a) | 26.0 | 100.0 | 76.0 | | 12.9 | 240.0 |
| | b) | 26.0 | 106.0 | 76.0 | | 12.9 | 249.9 |
| | c) | 26.0 | 111.0 | 92.0 | | 12.9 | 271.9 |
| Net Imported Supply | | -2.0 | 21.9 | -25.1 | | | -5.2 |
| | | -6.5 | 2.0 | -25.1 | | | -29.6 |
| | | -7.1 | -9.4 | -44.0 | | | -60.4 |
| TOTAL PRIMARY ENERGY | | 24.0 | 121.9 | 50.9 | | 12.9 | 234.8 |
| | | 19.5 | 108.0 | 50.9 | | 12.9 | 220.4 |
| | | 18.9 | 101.6 | 48.0 | | 12.9 | 211.5 |
| Electricity Generation | | 14.8 | 13.4 | 3.2 | -35.2 | 12.9 | 34.2 |
| | | 10.6 | 9.6 | 2.3 | -35.4 | 12.9 | 29.0 |
| | | 10.2 | 9.3 | 2.2 | -36.0 | 12.9 | 28.6 |
| TOTAL FINAL CONSUMPTION | | 9.2 | 108.5 | 47.7 | 35.2 | | 200.6 |
| | | 8.9 | 98.4 | 48.6 | 35.4 | | 191.4 |
| | | 8.7 | 92.4 | 45.8 | 36.0 | | 182.8 |
| Energy Sector & Losses ²⁾ | | 1.1 | 11.8 | 3.8 | 4.3 | | 20.0 |
| | | 1.1 | 9.8 | 3.8 | 4.3 | | 19.0 |
| | | 1.1 | 8.4 | 4.6 | 4.4 | | 18.5 |
| Industry | | 7.5 | 14.6 | 22.4 | 13.3 | | 57.8 |
| | | 7.2 | 12.6 | 20.9 | 13.3 | | 54.1 |
| | | 7.0 | 9.0 | 21.3 | 13.5 | | 50.7 |
| Transportation | | 0.1 | 52.7 | | | | 52.8 |
| | | 0.1 | 50.4 | | | | 50.5 |
| | | 0.1 | 48.3 | | | | 48.4 |
| Residential/Commercial | | 0.5 | 23.0 | 21.5 | 17.6 | | 62.6 |
| | | 0.5 | 18.5 | 23.9 | 17.8 | | 60.7 |
| | | 0.5 | 19.7 | 19.9 | 18.1 | | 58.3 |
| Non-Energy Oil | | | 7.4 | | | | 7.4 |
| | | | 7.1 | | | | 7.1 |
| | | | 6.9 | | | | 6.9 |

1) Oil supply includes 10 Mtoe oil from tar sands in all three cases; a) = Base projection; b) = \$6 projection; c) = \$9 projection.

2) Energy sector oil consumption includes the fuel needed to refine 600,000 barrels/day of imported oil intended for export.

Table 8. Canada 1985.

| Mtoe (10 ¹³ kcal) | Coal | Oil | Gas | Electricity | Nuclear | Hydro & Geo | Total |
|--------------------------------------|-------|-------|-------|-------------|---------|-------------|--------|
| Indigenous Supply ¹⁾ | 33.0 | 91.0 | 85.0 | | 25.0 | 28.7 | 262.7 |
| a) | 37.8 | 91.0 | 113.0 | | 25.0 | 37.0 | 303.8 |
| b) | 37.8 | 117.0 | 126.0 | | 25.0 | 43.0 | 348.8 |
| c) | | | | | | | |
| Net Imported Supply | 3.6 | 51.8 | -25.2 | | | | 30.2 |
| | -11.5 | 25.5 | -45.4 | | | | -31.4 |
| | -17.2 | -16.6 | -66.2 | | | | -100.0 |
| TOTAL PRIMARY ENERGY | 36.6 | 142.8 | 59.8 | | 25.0 | 28.7 | 292.9 |
| | 26.4 | 116.5 | 67.6 | | 25.0 | 37.0 | 272.4 |
| | 20.6 | 100.4 | 59.8 | | 25.0 | 43.0 | 248.8 |
| Electricity Generation | 27.4 | 12.8 | 3.2 | -46.9 | 25.0 | 28.7 | 50.2 |
| | 17.3 | 8.1 | 2.0 | -48.9 | 25.0 | 37.0 | 40.4 |
| | 11.8 | 5.5 | 1.4 | -51.0 | 25.0 | 43.0 | 35.7 |
| TOTAL FINAL CONSUMPTION | 9.2 | 130.0 | 56.6 | 46.9 | | | 242.7 |
| | 9.1 | 108.4 | 65.6 | 48.9 | | | 231.9 |
| | 8.8 | 94.9 | 58.4 | 51.0 | | | 213.1 |
| Energy Sector & Losses ²⁾ | 1.3 | 12.2 | 4.3 | 5.6 | | | 23.4 |
| | 1.5 | 9.7 | 8.7 | 5.8 | | | 25.7 |
| | 1.5 | 5.6 | 9.3 | 6.1 | | | 22.5 |
| Industry | 7.6 | 17.9 | 28.2 | 16.6 | | | 70.3 |
| | 7.3 | 10.9 | 28.5 | 17.3 | | | 64.0 |
| | 7.0 | 8.5 | 22.4 | 18.3 | | | 56.2 |
| Transportation | | 64.4 | | | | | 64.4 |
| | | 61.0 | | | | | 61.0 |
| | | 57.5 | | | | | 57.5 |
| Residential/Commercial | 0.3 | 26.7 | 24.1 | 24.7 | | | 75.8 |
| | 0.3 | 18.3 | 23.5 | 25.7 | | | 72.8 |
| | 0.3 | 15.1 | 26.7 | 26.6 | | | 68.7 |
| Non-Energy Oil | | 8.8 | | | | | 8.8 |
| | | 8.5 | | | | | 8.5 |
| | | 8.3 | | | | | 8.3 |

1) Oil supply includes 25 Mtoe from tar sands in all three cases; a) = Base projection; b) = \$6 projection; c) = \$9 projection.

2) Energy sector oil consumption in the base and \$6 cases includes the fuel needed to refine 600,000 barrels/day of imported oil intended for export.

EEC and OECD Europe

See Tables 9 to 14. In the EEC total primary requirements in 1980 are 5.4% below base case levels in the \$6 case and 9.5% below in the \$9 case. In 1985 the corresponding figures are 5.5% and 100%. The reductions for OECD Europe are almost identical.

The degree of energy self-sufficiency for the EEC in 1980 and 1985 is about 50% in the \$6 case and 55% in the \$9 case, compared with about 37% in the base case and in 1972. The figures for OECD Europe in 1980 and 1985 are one to two percentage points higher in the three cases.

Japan

See Tables 15 to 17. The reductions in total primary energy consumption below base case levels are larger than in other OECD regions--9.4% and 12.9% in 1980, and 11.2% and 17.0% in 1985 for the \$6 and \$9 cases respectively. These substantial reductions are primarily due to the assumption of larger oil price differences between the base case and the \$6 and \$9 cases than in other regions.

Since Japan possesses little domestic energy of her own, future indigenous production increases are confined largely to nuclear power. Japan will continue to depend heavily on imports of oil. In the \$9 cases oil imports are shown as 7.5 million barrels per day in 1980 and nine million barrels per day in 1985.

Australia and New Zealand

See Tables 18 to 23. Only one projection each was given for Australia and New Zealand. Both of these countries are expected to meet most of their oil consumption requirements from imports, although in absolute terms the amounts are

Table 9. EEC 1972.

| Mtoe (10 ¹³ kcal) | Coal | Oil | Gas | Electricity | Nuclear | Hydro & Geo | Total |
|--------------------------------|--------------|---------------------|--------------|-------------|-------------|-------------|--------------|
| Indigenous Supply | 214.5 | 11.9 | 110.7 | | 13.9 | 12.2 | 363.2 |
| Imported Supply (net) | 21.0 | 580.8 | 3.2 | | | | 605.0 |
| Stock Changes ¹⁾ | -4.8 | -4.1 | -0.6 | | | | -9.5 |
| TOTAL PRIMARY ENERGY | 230.7 | 588.6 | 113.3 | | 13.9 | 12.2 | 958.7 |
| Electricity Generation | 110.4 | 68.9 | 21.7 | -83.1 | 13.9 | 12.2 | 144.0 |
| TOTAL FINAL CONSUMPTION | 120.3 | 519.7 | 91.6 | 83.1 | | | 814.7 |
| Energy Sector & Losses | 15.4 | 31.1 | 4.7 | 10.0 | | | 61.4 |
| Industry | 62.5 | 125.1 | 47.3 | 38.8 | | | 273.7 |
| Transportation | 1.2 | 164.4 ²⁾ | 0.1 | 2.0 | | | 167.9 |
| Residential/Commercial | 41.0 | 146.5 | 39.5 | 32.3 | | | 259.3 |
| Non-Energy Oil | | 52.4 | | | | | 52.4 |

1) Withdrawals (+), Additions (-).

2) Includes 76.0 gasoline; 39.1 ships' bunkers.

Table 10. EEC 1980.

| Mtoe (10 ¹³ kcal) | Coal | Oil | Gas | Electricity | Nuclear | Hydro & Geo | Total |
|------------------------------|-------|-------|-------|-------------|---------|-------------|---------|
| Indigenous a) | 165.0 | 103.5 | 161.7 | | 72.6 | 14.7 | 517.5 |
| Supply b) | 200.0 | 160.0 | 198.0 | | 86.3 | 14.7 | 659.0 |
| c) | 205.0 | 170.0 | 225.0 | | 86.3 | 14.7 | 701.0 |
| Net Imported | 21.9 | 827.9 | 45.5 | | | | 895.3 |
| Supply | 42.8 | 571.0 | 64.0 | | | | 677.8 |
| | 45.6 | 457.8 | 74.0 | | | | 577.4 |
| TOTAL PRIMARY ENERGY | 186.9 | 931.4 | 207.2 | | | | 1,412.8 |
| | 242.8 | 731.0 | 262.0 | | | | 1,336.8 |
| | 250.6 | 627.8 | 299.0 | | | | 1,278.4 |
| Electricity Generation | 94.5 | 158.7 | 39.2 | -146.3 | 72.6 | 14.7 | 233.4 |
| | 150.0 | 100.8 | 40.0 | -154.7 | 86.3 | 14.7 | 237.0 |
| | 160.0 | 89.2 | 40.0 | -157.2 | 86.3 | 14.7 | 233.0 |
| TOTAL FINAL CONSUMPTION | 92.4 | 772.7 | 168.0 | 146.3 | 72.6 | 14.7 | 1,179.4 |
| | 92.8 | 630.2 | 222.0 | 154.7 | 86.3 | 14.7 | 1,099.7 |
| | 90.6 | 538.6 | 259.0 | 157.2 | 86.3 | 14.7 | 1,045.4 |
| Energy Sector & Losses | 13.2 | 62.2 | 18.9 | 18.1 | | | 112.4 |
| | 16.0 | 43.8 | 23.9 | 19.1 | | | 102.8 |
| | 16.4 | 35.1 | 27.3 | 19.5 | | | 98.2 |
| Industry | 62.4 | 191.3 | 74.2 | 65.4 | | | 393.3 |
| | 60.8 | 136.2 | 93.8 | 66.6 | | | 357.5 |
| | 58.8 | 103.1 | 106.2 | 65.0 | | | 333.1 |
| Transportation | | 234.5 | | 2.2 | | | 236.7 |
| | | 225.9 | | 2.2 | | | 228.1 |
| | | 218.8 | | 2.2 | | | 221.0 |
| Residential/Commercial | 16.8 | 197.2 | 74.9 | 60.6 | | | 349.5 |
| | 16.0 | 140.8 | 104.3 | 66.8 | | | 327.9 |
| | 15.4 | 100.8 | 125.6 | 70.5 | | | 312.3 |
| Non-Energy Oil | | 87.5 | | | | | 87.5 |
| | | 83.5 | | | | | 83.5 |
| | | 80.9 | | | | | 80.9 |

a) = Base projection;

b) = \$6 projection;

c) = \$9 projection.

Table 11. EEC 1985.

| Mtoe (10 ¹³ kcal) | Coal | Oil | Gas | Electricity | Nuclear | Hydro & Geo | Total |
|------------------------------|------|-------|---------|-------------|---------|-------------|---------|
| Indigenous Supply | a) | 152.2 | 125.2 | 199.2 | | 173.0 | 665.2 |
| | b) | 210.0 | 185.0 | 234.0 | | 201.7 | 846.3 |
| | c) | 215.0 | 200.0 | 252.0 | | 201.7 | 884.3 |
| Net Imported Supply | | 20.0 | 1,032.5 | 67.5 | | | 1,120.0 |
| | | 38.6 | 699.5 | 102.0 | | | 840.1 |
| | | 39.7 | 560.3 | 123.0 | | | 723.0 |
| TOTAL PRIMARY ENERGY | | 172.2 | 1,157.7 | 266.7 | | 173.0 | 1,785.2 |
| | | 248.6 | 884.5 | 336.0 | | 201.7 | 1,686.4 |
| | | 254.7 | 760.3 | 375.0 | | 201.7 | 1,607.3 |
| Electricity Generation | | 90.3 | 208.3 | 46.9 | -204.0 | 173.0 | 330.1 |
| | | 165.0 | 111.2 | 66.0 | -217.3 | 201.7 | 342.2 |
| | | 172.0 | 101.1 | 66.0 | -219.6 | 201.7 | 336.8 |
| TOTAL FINAL CONSUMPTION | | 81.9 | 949.4 | 219.8 | 204.0 | | 1,455.1 |
| | | 83.6 | 773.3 | 270.0 | 217.3 | | 1,344.2 |
| | | 82.7 | 659.2 | 309.0 | 219.6 | | 1,270.5 |
| Energy Sector & Losses | | 12.2 | 68.0 | 21.0 | 25.4 | | 126.6 |
| | | 16.8 | 46.6 | 26.5 | 27.1 | | 116.9 |
| | | 17.2 | 37.4 | 29.5 | 27.3 | | 111.5 |
| Industry | | 59.2 | 238.6 | 102.2 | 90.0 | | 490.0 |
| | | 57.0 | 175.2 | 120.3 | 91.0 | | 443.5 |
| | | 56.3 | 133.6 | 134.5 | 89.1 | | 413.5 |
| Transportation | | | 293.4 | | 2.7 | | 296.1 |
| | | | 281.1 | | 2.7 | | 283.8 |
| | | | 271.0 | | 2.7 | | 273.7 |
| Residential/Commercial | | 10.5 | 229.7 | 96.6 | 85.9 | | 422.7 |
| | | 9.8 | 156.2 | 123.3 | 96.5 | | 385.8 |
| | | 9.2 | 106.7 | 144.9 | 100.5 | | 361.3 |
| Non-Energy Oil | | | 119.7 | | | | 119.7 |
| | | | 114.2 | | | | 114.2 |
| | | | 110.6 | | | | 110.6 |

a) = Base projection;
b) = \$6 projection;
c) = \$9 projection.

Table 12. OECD Europe 1972.

| Mtoe (10 ¹³ kcal) | Coal | Oil | Gas | Electricity | Nuclear | Hydro & Geo | Total |
|--------------------------------|--------------|---------------------|--------------|--------------|-------------|-------------|----------------|
| Indigenous Supply | 230.1 | 19.8 | 112.6 | | 16.5 | 35.9 | 414.9 |
| Imported Supply (net) | 31.4 | 718.4 | 5.5 | | | | 755.3 |
| Stock Changes ¹⁾ | -4.6 | -7.5 | -0.6 | | | | -12.7 |
| TOTAL PRIMARY ENERGY | 256.9 | 730.7 | 117.5 | | 16.5 | 35.9 | 1,157.5 |
| Electricity Generation | 118.5 | 81.5 | 22.7 | -111.0 | 16.5 | 35.9 | 164.1 |
| TOTAL FINAL CONSUMPTION | 138.4 | 649.2 | 94.8 | 111.0 | | | 993.4 |
| Energy Sector & Losses | 18.3 | 35.2 | 5.2 | 13.5 | | | 72.2 |
| Industry | 73.7 | 161.1 | 49.0 | 53.2 | | | 337.0 |
| Transportation | 2.1 | 207.4 ²⁾ | 0.1 | 2.7 | | | 212.3 |
| Residential/Commercial | 44.3 | 186.7 | 40.5 | 41.6 | | | 313.1 |
| Non-Energy Oil | | 58.8 | | | | | 58.8 |

¹⁾ Withdrawals (+), Additions (-).

²⁾ Includes 93.7 gasoline; 45.6 ships' bunkers.

Table 13. OECD Europe 1980.

| Mtoe (10 ¹³ kcal) | Coal | Oil | Gas | Electricity | Nuclear | Hydro & Geo | Total |
|------------------------------|-------|---------|-------|-------------|---------|-------------|---------|
| Indigenous Supply | 190.2 | 192.7 | 171.8 | | 99.1 | 43.4 | 697.2 |
| a) | 225.0 | 220.0 | 228.0 | | 118.8 | 43.4 | 835.2 |
| b) | 230.0 | 236.0 | 255.0 | | 118.8 | 43.4 | 883.2 |
| c) | | | | | | | |
| Net Imported Supply | 34.4 | 948.5 | 49.4 | | | | 1,032.3 |
| | 55.5 | 679.8 | 62.0 | | | | 797.3 |
| | 59.5 | 544.8 | 74.0 | | | | 678.3 |
| TOTAL PRIMARY ENERGY | 224.6 | 1,141.2 | 221.2 | | 99.1 | 43.4 | 1,729.5 |
| | 280.5 | 899.8 | 290.0 | | 118.8 | 43.4 | 1,632.4 |
| | 289.5 | 780.8 | 329.0 | | 118.8 | 43.4 | 1,561.5 |
| Electricity Generation | 104.5 | 191.9 | 41.2 | -194.7 | 99.1 | 43.4 | 285.4 |
| | 161.0 | 122.3 | 44.0 | -202.5 | 118.8 | 43.4 | 287.0 |
| | 172.0 | 107.0 | 44.0 | -204.4 | 118.8 | 43.4 | 280.9 |
| TOTAL FINAL CONSUMPTION | 120.1 | 949.3 | 180.0 | 194.7 | | | 1,444.1 |
| | 119.5 | 777.5 | 246.0 | 202.5 | | | 1,345.5 |
| | 117.5 | 673.8 | 285.0 | 204.4 | | | 1,280.6 |
| Energy Sector & Losses | 15.2 | 75.7 | 21.9 | 24.3 | | | 137.1 |
| | 18.0 | 53.8 | 28.7 | 25.2 | | | 125.8 |
| | 18.4 | 43.6 | 32.6 | 25.5 | | | 120.1 |
| Industry | 81.7 | 231.2 | 78.6 | 90.4 | | | 481.9 |
| | 79.4 | 162.2 | 102.8 | 91.1 | | | 435.5 |
| | 77.8 | 124.2 | 115.5 | 89.1 | | | 406.6 |
| Transportation | | 289.8 | | 3.2 | | | 293.0 |
| | | 279.3 | | 3.2 | | | 282.5 |
| | | 270.6 | | 3.2 | | | 273.8 |
| Residential/Commercial | 23.2 | 250.1 | 79.5 | 76.8 | | | 429.6 |
| | 22.1 | 184.4 | 114.5 | 82.9 | | | 404.0 |
| | 21.3 | 140.7 | 136.9 | 86.6 | | | 385.5 |
| Non-Energy Oil | | 102.5 | | | | | 102.5 |
| | | 97.8 | | | | | 97.8 |
| | | 94.7 | | | | | 94.7 |

a) = Base projection;
b) = \$6 projection;
c) = \$9 projection.

Table 14. OECD Europe 1985.

| Mtoe (10 ¹³ kcal) | Coal | Oil | Gas | Electricity | Nuclear | Hydro & Geo | Total |
|--------------------------------|-------|---------|-------|-------------|---------|-------------|---------|
| Indigenous Supply | 183.2 | 251.7 | 249.1 | | 235.8 | 49.0 | 968.8 |
| a) | 241.0 | 285.0 | 288.0 | | 273.3 | 49.0 | 1,136.3 |
| b) | 246.0 | 300.0 | 315.0 | | 273.3 | 49.0 | 1,183.3 |
| c) | | | | | | | |
| Net Imported Supply | 31.8 | 1,189.8 | 54.5 | | | | 1,276.1 |
| | 52.3 | 835.6 | 97.0 | | | | 984.8 |
| | 52.5 | 666.9 | 120.0 | | | | 839.4 |
| TOTAL PRIMARY ENERGY | 215.0 | 1,441.5 | 303.6 | | 235.8 | 49.0 | 2,244.9 |
| | 293.3 | 1,120.6 | 385.0 | | 273.3 | 49.0 | 2,121.1 |
| | 298.5 | 966.9 | 435.0 | | 273.3 | 49.0 | 2,022.7 |
| Electricity Generation | 100.3 | 247.4 | 49.9 | -272.5 | 235.8 | 49.0 | 409.9 |
| | 177.0 | 133.9 | 72.0 | -285.1 | 273.3 | 49.0 | 420.1 |
| | 185.0 | 119.8 | 72.0 | -286.7 | 273.3 | 49.0 | 412.5 |
| TOTAL FINAL CONSUMPTION | 114.7 | 1,194.1 | 253.7 | 272.5 | | | 1,835.0 |
| | 116.3 | 986.7 | 313.0 | 285.1 | | | 1,701.0 |
| | 113.5 | 847.1 | 363.0 | 286.7 | | | 1,610.2 |
| Energy Sector & Losses | 14.7 | 83.3 | 27.5 | 34.1 | | | 159.6 |
| | 19.3 | 58.4 | 34.9 | 35.7 | | | 148.2 |
| | 19.7 | 46.9 | 39.4 | 35.9 | | | 146.8 |
| Industry | 80.6 | 296.5 | 117.4 | 125.3 | | | 619.8 |
| | 78.9 | 221.2 | 138.7 | 125.8 | | | 564.6 |
| | 76.8 | 169.9 | 157.4 | 123.4 | | | 524.5 |
| Transportation | | 369.2 | | 4.2 | | | 373.4 |
| | | 353.8 | | 4.2 | | | 358.0 |
| | | 341.3 | | 4.2 | | | 345.5 |
| Residential/Commercial | 19.4 | 305.4 | 108.8 | 108.9 | | | 542.5 |
| | 18.1 | 220.0 | 139.4 | 119.4 | | | 496.9 |
| | 17.0 | 159.9 | 166.2 | 123.2 | | | 466.3 |
| Non-Energy Oil | | 139.7 | | | | | 139.7 |
| | | 133.3 | | | | | 133.3 |
| | | 129.1 | | | | | 129.1 |

a) = Base projection;
b) = \$6 projection;
c) = \$9 projection.

Table 15. Japan 1972.

| Mtoe (10 ¹³ kcal) | Coal | Oil | Gas | Electricity | Nuclear | Hydro & Geo | Total |
|--------------------------------|-------------|--------------------|------------|-------------|------------|-------------|--------------|
| Indigenous Supply | 18.8 | 0.7 | 2.7 | | 2.3 | 9.4 | 33.9 |
| Imported Supply (net) | 38.9 | 247.5 | 1.3 | | | | 287.7 |
| Stock Changes ¹⁾ | -0.5 | -2.8 | | | | | -3.3 |
| TOTAL PRIMARY ENERGY | 57.2 | 245.4 | 4.0 | | 2.3 | 9.4 | 318.3 |
| Electricity Generation | 5.7 | 65.5 | 1.5 | -37.9 | 2.3 | 9.4 | 46.5 |
| Manufactured Gas | 4.5 | 3.0 | -5.1 | | | | 2.4 |
| TOTAL FINAL CONSUMPTION | 47.0 | 176.9 | 7.9 | 37.9 | | | 269.4 |
| Energy Sector & Losses | 6.0 | 10.3 | 0.8 | 3.5 | | | 20.6 |
| Industry | 39.7 | 52.1 | 2.0 | 24.7 | | | 118.5 |
| Transportation | 0.4 | 48.4 ²⁾ | | 1.8 | | | 50.6 |
| Residential/Commercial | 0.9 | 31.7 | 4.9 | 7.9 | | | 45.4 |
| Non-Energy Oil | | 34.3 | | | | | 34.3 |

¹⁾ Withdrawals (+), Additions (-).

²⁾ Includes 20.0 gasoline; 11.9 ships' bunkers.

Table 16. Japan 1980.

| Mtoe (10 ¹³ kcal) | Coal | Oil | Gas | Electricity | Nuclear | Hydro & Geo | Total |
|------------------------------|------|-------|------|-------------|--------------------|-------------|-------|
| Indigenous Supply | 14.0 | 2.0 | 1.8 | | 54.2 ¹⁾ | 10.4 | 82.4 |
| a) | 15.8 | 2.0 | 1.8 | | 54.2 ¹⁾ | 10.4 | 84.2 |
| b) | 15.8 | 3.0 | 3.0 | | 54.2 ¹⁾ | 10.4 | 86.4 |
| c) | | | | | | | |
| Net Imported Supply | 53.9 | 476.2 | 23.9 | | | | 554.0 |
| | 53.6 | 407.6 | 31.3 | | | | 492.5 |
| | 54.7 | 382.4 | 31.0 | | | | 468.1 |
| TOTAL PRIMARY ENERGY | 67.9 | 478.2 | 25.7 | | 54.2 | 10.4 | 636.4 |
| | 69.4 | 409.6 | 33.1 | | 54.2 | 10.4 | 576.7 |
| | 70.5 | 385.4 | 34.0 | | 54.2 | 10.4 | 554.5 |
| Electricity Generation | 5.9 | 75.8 | 15.9 | -63.4 | 54.2 | 10.4 | 98.8 |
| | 10.1 | 52.6 | 20.5 | -58.6 | 54.2 | 10.4 | 89.2 |
| | 10.5 | 47.3 | 21.5 | -57.1 | 54.2 | 10.4 | 86.8 |
| Manufactured Gas | 5.5 | 3.7 | -6.1 | | | | 3.1 |
| | 1.8 | 8.7 | -6.7 | | | | 3.8 |
| | 2.0 | 11.0 | -8.3 | | | | 4.7 |
| TOTAL FINAL CONSUMPTION | 56.5 | 398.7 | 15.9 | 63.4 | | | 534.5 |
| | 57.5 | 348.3 | 19.3 | 58.6 | | | 483.7 |
| | 58.0 | 327.1 | 20.8 | 57.1 | | | 463.0 |
| Energy Sector & Losses | 7.3 | 18.3 | 1.7 | 6.5 | | | 33.8 |
| | 7.3 | 16.0 | 1.7 | 6.5 | | | 31.5 |
| | 7.3 | 15.6 | 1.7 | 6.5 | | | 31.1 |
| Industry | 49.2 | 131.0 | 2.1 | 43.6 | | | 225.9 |
| | 50.2 | 106.6 | 2.1 | 39.5 | | | 198.4 |
| | 50.7 | 97.7 | 2.1 | 38.5 | | | 189.0 |
| Transportation | | 90.0 | | 2.0 | | | 92.0 |
| | | 84.2 | | 2.0 | | | 86.2 |
| | | 81.2 | | 2.0 | | | 83.2 |
| Residential/Commercial | | 98.9 | 12.1 | 11.3 | | | 122.3 |
| | | 85.0 | 15.5 | 10.6 | | | 111.1 |
| | | 77.9 | 17.0 | 10.1 | | | 105.0 |
| Non Energy Oil | | 60.5 | | | | | 60.5 |
| | | 56.5 | | | | | 56.5 |
| | | 54.7 | | | | | 54.7 |

a) = Pre-October 1975 forecast;

b) = \$6 projection;

c) = \$9 projection.

¹⁾ Since those energy balances were drawn up, the Japanese forecast for nuclear power in 1980 has been revised downwards. New estimates are in the range 33 to 38 Mtoe.

Table 17. Japan 1985.

| Mtoe (10 ¹³ kcal) | Coal | Oil | Gas | Electricity | Nuclear | Hydro & Geo | Total |
|------------------------------|------|-------|------|-------------|---------|-------------|-------|
| Indigenous Supply | 14.0 | 2.0 | 1.8 | | 101.7 | 11.5 | 131.0 |
| a) | 15.8 | 6.0 | 6.0 | | 101.7 | 11.5 | 141.0 |
| b) | 15.8 | 8.0 | 7.2 | | 101.7 | 11.5 | 144.2 |
| c) | | | | | | | |
| Net Imported Supply | 63.0 | 620.3 | 39.8 | | | | 723.1 |
| | 73.4 | 505.1 | 39.0 | | | | 617.5 |
| | 77.0 | 447.7 | 39.6 | | | | 564.3 |
| TOTAL PRIMARY ENERGY | 77.0 | 622.3 | 41.6 | | 101.7 | 11.5 | 854.1 |
| | 89.2 | 511.1 | 45.0 | | 101.7 | 11.5 | 758.5 |
| | 92.8 | 455.7 | 46.8 | | 101.7 | 11.5 | 708.5 |
| Electricity Generation | 5.9 | 73.1 | 26.6 | -83.1 | 101.7 | 11.5 | 135.7 |
| | 16.1 | 47.0 | 28.0 | -78.3 | 101.7 | 11.5 | 126.0 |
| | 18.7 | 40.0 | 29.0 | -77.0 | 101.7 | 11.5 | 23.9 |
| Manufactured Gas | 2.1 | 11.7 | -9.1 | | | | 4.7 |
| | 2.1 | 11.7 | -9.1 | | | | 4.7 |
| | 2.1 | 11.7 | -9.1 | | | | 4.7 |
| TOTAL FINAL CONSUMPTION | 69.0 | 537.5 | 24.1 | 83.1 | | | 731.7 |
| | 71.0 | 452.4 | 26.1 | 78.3 | | | 627.8 |
| | 72.0 | 404.0 | 26.9 | 77.0 | | | 579.9 |
| Energy Sector & Losses | 7.7 | 24.5 | 3.6 | 8.6 | | | 44.4 |
| | 7.7 | 21.5 | 3.6 | 8.0 | | | 40.8 |
| | 7.7 | 19.5 | 3.6 | 7.8 | | | 38.6 |
| Industry | 61.3 | 193.4 | 2.4 | 53.4 | | | 318.5 |
| | 63.3 | 143.0 | 2.4 | 50.3 | | | 259.0 |
| | 64.3 | 113.3 | 2.2 | 49.9 | | | 229.7 |
| Transportation | | 126.9 | | 4.0 | | | 138.9 |
| | | 118.7 | | 4.0 | | | 122.7 |
| | | 114.3 | | 4.0 | | | 118.3 |
| Residential/Commercial | | 104.6 | 18.1 | 17.1 | | | 139.8 |
| | | 86.9 | 20.1 | 16.0 | | | 123.0 |
| | | 77.3 | 21.1 | 15.3 | | | 113.7 |
| Non-Energy Oil | | 88.1 | | | | | 88.1 |
| | | 82.3 | | | | | 82.3 |
| | | 79.6 | | | | | 79.6 |

a) = Pre-October 1973 forecast;

b) = \$6 projection;

c) = \$9 projection.

Table 18. Australia 1972.

| Mtoe (10 ¹³ kcal) | Coal | Oil | Gas | Electricity | Nuclear | Hydro & Geo | Total |
|------------------------------|-------|--------------------|-----|-------------|---------|-------------|--------------------|
| Indigenous Supply | 43.0 | 15.9 | 2.9 | | | 1.2 | 63.0 |
| Imported Supply (net) | -16.6 | 12.5 | | | | | -4.1 |
| Stock Changes ¹⁾ | -3.0 | -0.1 | | | | | -3.1 |
| TOTAL PRIMARY ENERGY | 23.4 | 28.3 | 2.9 | | | 1.2 | 55.8 ²⁾ |
| ELECTRICITY GENERATION | 14.0 | 0.5 | 0.7 | -4.8 | | 1.2 | 11.6 |
| TOTAL FINAL CONSUMPTION | 9.4 | 27.8 | 2.2 | 4.8 | | | 44.2 |
| Energy Sector & Losses | 1.9 | 2.5 | 0.5 | 0.7 | | | 5.6 |
| Industry | 6.4 | 5.1 | 1.1 | 2.5 | | | 15.1 |
| Transportation | | 14.6 ³⁾ | | 0.1 | | | 14.7 |
| Residential/Commercial | 1.1 | 3.7 | 0.6 | 1.6 | | | 7.0 |
| Non-Energy Oil | | 1.9 | | | | | 1.9 |

1) Withdrawals (+), Additions (-).

2) A further 2 Mtoe of wood and bagasse are used for energy purposes.

3) Includes 9.3 gasoline; 2.5 ships' bunkers.

Table 19. Australia 1980.¹⁾

| Mtoe (10 ¹³ kcal) | Coal | Oil | Gas | Electricity | Nuclear | Hydro & Geo | Total |
|------------------------------|-------|------|------|-------------|---------|-------------|--------------------|
| Indigenous Supply | 69.8 | 19.6 | 17.6 | | | 1.5 | 108.5 |
| Net Imported Supply | -32.5 | 21.7 | | | | | -10.8 |
| TOTAL PRIMARY ENERGY | 37.3 | 41.3 | 17.6 | | | 1.5 | 97.7 ²⁾ |
| Electricity Generation | 20.1 | 1.9 | 1.8 | -8.7 | | 1.5 | 16.6 |
| TOTAL FINAL CONSUMPTION | 17.2 | 39.4 | 15.8 | 8.7 | | | 81.1 |
| Energy Sector & Losses | 3.3 | 3.8 | 2.3 | 1.0 | | | 10.4 |
| Industry | 12.4 | 5.9 | 9.5 | 3.4 | | | 31.2 |
| Transportation | | 22.3 | | 0.1 | | | 22.4 |
| Residential/Commercial | 1.5 | 5.2 | 4.0 | 4.3 | | | 15.0 |
| Non-Energy Oil | | 2.2 | | | | | 2.2 |

¹⁾ Pre-October 1973 forest.

²⁾ A further 2 Mtoe of wood and bagasse are used for energy purposes.

Table 20. Australia 1985.¹⁾

| Mtoe (10 ¹³ kcal) | Coal | Oil | Gas | Electricity | Nuclear | Hydro & Geo | Total |
|------------------------------|-------|------|------|-------------|---------|-------------|---------------------|
| Indigenous Supply | 89.2 | 16.0 | 24.8 | | | 1.8 | 131.8 ²⁾ |
| Net Imported Supply | -35.8 | 37.4 | | | | | 1.6 |
| TOTAL PRIMARY ENERGY | 53.4 | 53.4 | 24.8 | | | 1.8 | 133.4 ²⁾ |
| Electricity Generation | 28.5 | 3.7 | 1.8 | -11.8 | | 1.8 | 24.0 |
| TOTAL FINAL CONSUMPTION | 24.9 | 49.7 | 23.0 | 11.8 | | | 109.4 |
| Energy Sector & Losses | 4.2 | 4.9 | 3.2 | 1.4 | | | 13.5 |
| Industry | 18.7 | 6.5 | 13.2 | 4.3 | | | 42.7 |
| Transportation | | 28.2 | | 0.1 | | | 28.3 |
| Residential/Commercial | 2.0 | 6.0 | 6.6 | 6.0 | | | 20.6 |
| Non-Energy Oil | | 4.3 | | | | | 4.3 |

1) Pre-October 1973 forecast.

2) A further 2 Mtoe of wood and bagasse are used for energy purposes.

Table 21. New Zealand 1972.

| Mtoe (10^{13} kcal) | Coal | Oil | Gas | Electricity | Nuclear | Hydro & Geo | Total |
|-------------------------|------------------|-----|------------------|------------------|---------|-------------|-------|
| Indigenous Supply | 1.3 | 0.1 | 0.3 | | | 1.6 | 3.3 |
| Imported Supply (net) | ~0 ¹⁾ | 4.1 | | | | | 4.1 |
| TOTAL PRIMARY ENERGY | 1.3 | 4.2 | 0.3 | | | 1.6 | 7.4 |
| Electricity Generation | 0.3 | 0.2 | 0.1 | -1.5 | | 1.6 | 0.7 |
| TOTAL FINAL CONSUMPTION | 1.0 | 4.0 | 0.2 | 1.5 | | | 6.7 |
| Energy Sector & Losses | ~0 ¹⁾ | 0.3 | 0.1 | 0.2 | | | 0.6 |
| Industry | 0.6 | 1.1 | 0.1 | 0.5 | | | 2.3 |
| Transportation | | 2.3 | | ~0 ¹⁾ | | | 2.3 |
| Residential/Commercial | 0.4 | 0.2 | ~0 ¹⁾ | 0.8 | | | 1.4 |
| Non-Energy Oil | | 0.1 | | | | | 0.1 |

¹⁾ Less than 0.05 Mtoe.

Table 22. New Zealand 1980.¹⁾

| Mtoe (10 ¹³ kcal) | Coal | Oil | Gas | Electricity | Nuclear | Hydro & Geo | Total |
|------------------------------|------|-----|-----|-------------|---------|-------------|-------|
| Indigenous Supply | 1.6 | 0.8 | 2.5 | | | 2.4 | 7.3 |
| Net Imported Supply | | 4.1 | | | | | 4.1 |
| TOTAL PRIMARY ENERGY | 1.6 | 4.9 | 2.5 | | | 2.4 | 11.4 |
| Electricity Generation | 0.6 | 0.2 | 1.8 | -2.8 | | 2.4 | 2.2 |
| TOTAL FINAL CONSUMPTION | 1.0 | 4.7 | 0.7 | 2.8 | | | 9.2 |
| Energy Sector & Losses | 0 | 0.2 | 0.1 | 0.3 | | | 0.6 |
| Industry | 0.7 | 0.9 | 0.5 | 0.8 | | 2) | 2.9 |
| Transportation | | 3.1 | | | | | 3.1 |
| Residential/Commercial | 0.3 | 0.4 | 0.1 | 1.7 | | | 2.5 |
| Non-Energy Oil | | 0 | | | | | |

¹⁾ Crude oil price similar to 1974 level.

²⁾ A small amount of geothermal heat (about 0.02 Mtoe) is expected to be used for industrial purposes.

Table 23. New Zealand 1985.¹⁾

| Mtoe (10 ¹³ kcal) | Coal | Oil | Gas | Electricity | Nuclear | Hydro & Geo | Total |
|------------------------------|------|-----|-----|-------------|---------|-------------------|-------|
| Indigenous Supply | 2.1 | 1.0 | 4.4 | | | 3.0 | 10.5 |
| Net Imported Supply | | 3.7 | | | | | 3.7 |
| TOTAL PRIMARY ENERGY | 2.1 | 4.7 | 4.4 | | | 3.0 | 14.2 |
| Electricity Generation | 1.0 | 0.2 | 3.3 | -3.9 | | 2.9 ²⁾ | 3.5 |
| TOTAL FINAL CONSUMPTION | 1.1 | 4.5 | 1.1 | 3.9 | | | 10.6 |
| Energy Sector & Losses | 0 | 0.2 | 0.1 | 0.5 | | | 0.8 |
| Industry | 0.8 | 0.9 | 0.6 | 1.0 | | 3) | 3.3 |
| Transportation | | 3.2 | 0.1 | | | | 3.3 |
| Residential/Commercial | 0.2 | 0.3 | 0.2 | 2.4 | | | 3.1 |
| Non-Energy Oil | | | | | | | |

1) Crude oil price is similar to 1974 level.

2) Difference is due to pumped storage.

3) A small amount of geothermal heat about 0.02 Mtoe) is expected to be used for industrial purposes.

small. Both countries are projected to supply domestic requirements of other forms of energy from indigenous resources and Australia will continue to export substantial amounts of coal.

The Overall OECD Area

See Tables 24 to 28. The most important consequence of the higher oil prices is the effect on OECD oil imports. For 1980 they are shown as 28% below the base projections in the \$6 case and 46% below in the \$9 case. Imports in the \$6 case are only a little higher than 1974 levels, which were less than in 1973, while those in the \$9 case are somewhat below. Imports for 1985 are higher in all cases than in 1980 except for the \$9 case, in which they are slightly lower.

The reductions in oil imports below base case levels may be explained as follows. In 1980, in the \$9 case, the reduction is just under 1,000 million tons of oil equivalent (Mtoe). Of this 21% is due to increased indigenous oil production and the rest to reduced oil consumption. Of the reduction in oil consumption (736 Mtoe) 37% is due to increased consumption of other forms of energy (substitution) and 63% to the reduction in total primary requirements. In 1985 the change in oil imports from the base case is over 1,500 Mtoe, of which 28% may be attributed to increased OECD indigenous oil production and 72% to reduced consumption. Of the reduction in oil consumption, substitution by other fuels accounts for 31%, and overall reduction in energy consumption for 69%. Overall energy consumption decrease relative to the base case is responsible for half of the reduction in oil imports in both 1980 and 1985.

Imports of natural gas are also reduced from base case levels. Between the base and the \$9 case, net imports of gas

Table 24. Alternative projections of OECD energy production, imports and consumption in 1980, compared with 1972 levels.

| Mtoe (10 ¹³ kcal) | Actual 1972 ⁴⁾ Date | Base Projection | \$6 Case | % Change | \$9 Case | % Change |
|--|--------------------------------------|--------------------|-------------------|-------------|-------------------|-------------|
| COAL | | | | | | |
| Indigenous | 670.3 | 771.6 | 875.2 | +13.4 | 880.2 | +14.1 |
| Imports | 21.3 | 9.2 | 23.3 | +153.3 | 9.7 | +5.4 |
| Consumption | 689.8 | 780.8 | 898.5 | +15.1 | 889.9 | +14.0 |
| OIL | | | | | | |
| Indigenous | 692.6 | 896.0 | 998.4 | +11.4 | 1,089.4 | +21.6 |
| Imports | 1,224.3 | 2,014.3 | 1,446.4 | -28.2 | 1,084.4 | -46.2 |
| Consumption | 1,917.3 | 2,910.3 | 2,444.8 | -16.0 | 2,173.8 | -25.3 |
| NATURAL GAS | | | | | | |
| Indigenous | 747.0 | 766.1 | 866.9 | +13.2 | 983.0 | +28.3 |
| Imports | 7.1 | 186.5 | 126.6 | -32.1 | 103.2 | -44.7 |
| Consumption | 744.5 | 952.6 | 993.5 | +4.3 | 1,086.3 | +14.0 |
| NUCLEAR¹⁾ | | | | | | |
| | 34.8 | 305.9 | 325.6 | +6.4 | 325.6 | +6.4 |
| HYDRO & GEO-THERMAL²⁾ | | | | | | |
| | 96.9 | 117.9 | 123.5 | +4.8 | 124.5 | +5.6 |
| GROSS ELECTRICITY PRODUCTION³⁾ | | | | | | |
| | 345.3 | 672.5 | 571.0 | -0.3 | 569.1 | -0.6 |
| TOTAL PRIMARY ENERGY (TPE) | | | | | | |
| | 3,463.3 | 5,067.6 | 4,786.0 | -5.6 | 4,600.2 | -9.2 |
| INDIGENEOUS SUPPLY (% of TPE) | | | | | | |
| | 2,241.8 (64.7) | 2,857.5 (56.4) | 3,189.6 (66.6) | +11.6 | 3,402.8 (74.0) | +19.1 |
| IMPORTS (% of TPE) | | | | | | |
| | 1,253.3 (36.2) | 2,210.1 (43.6) | 1,596.4 (33.4) | -27.8 | 1,197.4 (26.0) | -45.8 |

1) Primary energy equivalent (1 TWh = 0.2436 Mtoe).

2) Primary energy equivalent (1 TWh = 0.1064 Mtoe).

3) Calorific content of electricity produced (1 TWh = 0.086 Mtoe).

4) Stock changes excluded: they represent the difference between indigenous + imports and consumption.

Table 25. Alternative projections of OECD energy production, imports and consumption in 1985, compared with 1972 levels.

| Mtoe (10 ¹³ kcal) | Actual 1972 ⁴⁾ Date | Base Projection | \$6 Case | % Change | \$9 Case | % Change |
|--|--------------------------------------|--------------------|-------------------|-------------|-------------------|-------------|
| COAL | | | | | | |
| Indigenous | 670.3 | 943.9 | 1,045.9 | +10.8 | 1,050.9 | +11.3 |
| Imports | 21.3 | 7.1 | 2.3 | -67.6 | -14.8 | |
| Consumption | 869.8 | 951.0 | 1,048.2 | +10.0 | 1,036.1 | +8.9 |
| OIL | | | | | | |
| Indigenous | 692.6 | 937.1 | 1,149.0 | +22.6 | 1,380.0 | +47.3 |
| Imports | 1,224.3 | 2,634.0 | 1,661.9 | -36.9 | 1,071.6 | -59.3 |
| Consumption | 1,917.3 | 3,571.1 | 2,810.9 | -21.3 | 2,451.6 | -31.3 |
| NATURAL GAS | | | | | | |
| Indigenous | 747.0 | 827.7 | 1,019.2 | +23.1 | 1,100.4 | +32.9 |
| Imports | 7.1 | 280.1 | 177.8 | -36.6 | 144.4 | -48.4 |
| Consumption | 744.5 | 1,107.8 | 1,197.0 | +8.1 | 1,244.8 | +12.4 |
| NUCLEAR¹⁾ | 34.8 | 657.2 | 756.1 | +15.0 | 786.1 | +15.0 |
| HYDRO & GEO-THERMAL²⁾ | 96.9 | 133.4 | 154.1 | +16.0 | 161.5 | +21.1 |
| GROSS ELECTRICITY PRODUCTION³⁾ | 345.3 | 787.7 | 791.1 | +0.4 | 790.9 | +0.4 |
| TOTAL PRIMARY ENERGY (TPE) | 3,463.3 | 6,420.5 | 5,966.6 | -7.1 | 5,650.5 | -12.0 |
| INDIGENOUS SUPPLY (% of TPE) | 2,241.8 (+4.7) | 3,499.3 | 4,124.8 (69.1) | +25.0 | 4,448.9 (78.7) | +34.8 |
| IMPORTS (% of TPE) | 1,253.3 (36.7) | 2,921.2 | 1,841.8 (30.9) | -41.0 | 1,201.1 (21.3) | -61.5 |

1) Primary energy equivalent (1 TWh = 0.2436 Mtoe).

2) Primary energy equivalent (1 TWh = 0.1064 Mtoe).

3) Calorific content of electricity produced (1 TWh = 0.086 Mtoe).

4) Stock changes excluded: they represent the difference between indigenous + imports and consumption.

Table 26. Total primary energy requirements and average annual energy consumption growth rates for the base projection, \$6 and \$9 cases for the period 1972-1985.

| | USA | Canada | EEC | OECD Europe | Japan | Australia ¹⁾ | New Zealand ¹⁾ | Total OECD |
|---------------------------------|---------|--------|---------|-------------|-------|-------------------------|---------------------------|------------|
| TPER ²⁾ 1972 | 1,769.2 | 155.1 | 958.7 | 1,157.5 | 318.3 | 55.8 | 7.4 | 3,463.3 |
| 1980: | | | | | | | | |
| Base Projection TPER | 2,357.8 | 234.8 | 1,412.5 | 1,729.5 | 636.4 | 97.7 | 11.4 | 5,067.6 |
| Average Growth Rate 1972-80 (%) | 3.7 | 5.3 | 5.0 | 5.1 | 9.0 | 7.3 | 5.5 | 4.9 |
| \$6 Case TPER | 2,247.4 | 220.4 | 1,336.8 | 1,632.4 | 576.7 | | | 4,786.0 |
| % Decrease from Base Projection | -4.7 | -6.1 | -5.4 | -5.6 | -9.4 | | | -5.6 |
| Average Growth Rate 1972-80 (%) | 3.0 | 4.5 | 4.2 | 4.4 | 7.7 | | | 4.1 |
| \$9 Case TPER | 2,163.6 | 211.5 | 1,278.4 | 1,561.5 | 554.5 | | | 4,600.2 |
| % Decrease from Base Projection | -8.2 | -9.9 | -9.5 | -9.7 | -12.9 | | | -9.2 |
| Average Growth Rate 1972-80 (%) | 2.5 | 4.0 | 3.7 | 3.8 | 7.2 | | | 3.6 |
| 1985: | | | | | | | | |
| Base Projection TPER | 2,881.0 | 292.9 | 1,785.2 | 2,244.9 | 854.1 | 133.4 | 14.2 | 6,420.5 |
| Average Growth Rate 1972-85 (%) | 3.8 | 5.0 | 4.9 | 5.2 | 7.9 | 6.9 | 5.1 | 4.9 |
| \$6 Case TPER | 2,667.0 | 272.4 | 1,686.4 | 2,121.1 | 758.5 | | | 5,966.6 |
| % Decrease from Base Projection | -7.4 | -7.0 | -5.5 | -5.5 | -11.2 | | | -7.1 |
| Average Growth Rate 1972-85 (%) | 3.2 | 4.4 | 4.4 | 4.8 | 6.9 | | | 4.3 |
| \$9 Case TPER | 2,522.4 | 248.8 | 1,607.3 | 2,022.7 | 708.5 | | | 5,650.0 |
| % Decrease from Base Projection | -12.4 | -15.1 | -10.0 | -9.9 | -17.0 | | | -12.0 |
| Average Growth Rate 1972-85 (%) | 2.8 | 3.7 | 4.1 | 4.4 | 6.3 | | | 3.6 |

¹⁾ No alternative cases.

²⁾ Total Primary Energy Requirements in Mtoe (10¹³ kcal).

Table 27. Percentage shares of different forms of energy in overall energy consumption of OECD regions in 1972.

| % of TPE | Coal | Oil | Natural Gas | Nuclear | Hydro/ Geothermal | Electricity (2) |
|----------------|------|------|-------------|---------|----------------------|--------------------|
| USA | 17.7 | 46.6 | 33.2 | 0.8 | 1.7 | (11.2) |
| CANADA | 11.5 | 54.1 | 20.9 | 0.1 | 12.3 | (14.6) |
| EEC | 24.1 | 61.4 | 11.8 | 1.5 | 1.3 | (10.2) |
| OECD EUROPE | 22.0 | 63.1 | 10.2 | 1.4 | 3.1 | (11.2) |
| JAPAN | 18.0 | 77.1 | 1.2 | 0.7 | 3.0 | (14.1) |
| AUSTRALIA | 41.9 | 50.7 | 5.2 | | 2.2 | (10.9) |
| NEW ZEALAND | 17.6 | 56.8 | 4.1 | | 21.6 | (22.4) |
| TOTAL OECD | 19.3 | 55.4 | 21.5 | 1.0 | 2.8 | (11.6) |

Table 28. Percentage shares of different forms of energy in overall energy consumption of OECD regions in 1980 and 1985.

| % of TPE ¹⁾ | Coal | Oil | Natural Gas | Nuclear | Hydro/Geothermal | (Electricity ²⁾) | Coal | Oil | Natural Gas | Nuclear | Hydro/Geothermal | (Electricity ²⁾) |
|---------------------------------|------|------|-------------|---------|------------------|------------------------------|------|------|-------------|---------|------------------|------------------------------|
| USA | | | | | | | | | | | | |
| Base Case | 18.0 | 47.6 | 26.9 | 5.9 | 1.5 | (14.0) | 19.7 | 45.3 | 23.4 | 10.2 | 1.4 | (16.4) |
| \$6 Case | 21.8 | 43.7 | 26.7 | 6.2 | 1.6 | (14.6) | 21.9 | 37.7 | 25.1 | 13.4 | 2.0 | (17.4) |
| \$9 Case | 21.8 | 39.7 | 30.3 | 6.5 | 1.7 | (15.1) | 22.5 | 34.5 | 26.7 | 14.1 | 2.1 | (18.4) |
| CANADA | | | | | | | | | | | | |
| Base Case | 10.2 | 51.9 | 21.7 | 5.5 | 10.7 | (17.5) | 12.5 | 48.8 | 20.4 | 8.5 | 9.8 | (19.3) |
| \$6 Case | 8.8 | 49.0 | 23.1 | 5.9 | 13.2 | (18.5) | 9.7 | 42.8 | 24.8 | 9.2 | 13.6 | (21.1) |
| \$9 Case | 8.9 | 48.0 | 22.7 | 6.1 | 14.2 | (19.7) | 8.3 | 40.4 | 24.0 | 10.0 | 17.3 | (23.9) |
| EEC | | | | | | | | | | | | |
| Base Case | 13.2 | 65.9 | 14.7 | 5.1 | 1.0 | (12.4) | 9.6 | 64.8 | 14.9 | 9.7 | 0.9 | (14.0) |
| \$6 Case | 18.2 | 54.7 | 19.6 | 6.5 | 1.1 | (14.1) | 14.7 | 52.4 | 19.9 | 12.0 | .9 | (16.2) |
| \$9 Case | 19.6 | 49.1 | 23.4 | 6.8 | 1.1 | (14.1) | 15.8 | 47.3 | 23.3 | 12.5 | 1.0 | (17.3) |
| OECD EUROPE | | | | | | | | | | | | |
| Base Case | 13.0 | 66.0 | 12.8 | 5.7 | 2.5 | (13.5) | 9.6 | 64.2 | 13.5 | 10.5 | 2.2 | (14.9) |
| \$6 Case | 17.2 | 55.1 | 17.8 | 7.3 | 2.7 | (15.1) | 13.8 | 52.8 | 18.2 | 12.9 | 2.3 | (16.8) |
| \$9 Case | 18.5 | 50.0 | 21.1 | 7.6 | 2.8 | (16.0) | 14.8 | 47.5 | 21.5 | 13.5 | 2.4 | (17.8) |
| JAPAN | | | | | | | | | | | | |
| Base Case | 10.7 | 75.1 | 4.0 | 8.5 | 1.6 | (11.9) | 9.0 | 72.9 | 4.9 | 11.9 | 1.3 | (11.6) |
| \$6 Case | 12.0 | 71.0 | 5.7 | 9.4 | 1.8 | (12.1) | 11.8 | 67.4 | 5.9 | 13.4 | 1.5 | (12.5) |
| \$9 Case | 12.7 | 69.5 | 6.1 | 9.8 | 1.9 | (12.3) | 13.1 | 64.3 | 6.6 | 14.4 | 1.6 | (13.3) |
| AUSTRALIA³⁾ | | | | | | | | | | | | |
| | 38.2 | 42.3 | 18.0 | - | 1.5 | (10.7) | 40.0 | 40.0 | 18.6 | - | 1.3 | (10.8) |
| NEW ZEALAND³⁾ | | | | | | | | | | | | |
| | 14.0 | 43.0 | 21.9 | - | 21.1 | (30.4) | 14.8 | 33.1 | 31.0 | - | 21.1 | (36.8) |
| TOTAL OECD | | | | | | | | | | | | |
| Base Case | 15.4 | 57.4 | 18.8 | 6.0 | 2.3 | (13.7) | 14.8 | 55.6 | 17.5 | 10.2 | 2.1 | (15.2) |
| \$6 Case | 18.8 | 51.0 | 20.8 | 6.8 | 2.6 | (14.6) | 17.6 | 47.1 | 20.1 | 12.7 | 2.6 | (16.6) |
| \$9 Case | 19.3 | 47.3 | 23.6 | 7.1 | 2.7 | (15.2) | 18.3 | 43.4 | 22.0 | 13.4 | 2.8 | (17.7) |

1) Total Primary Energy Requirements.

2) As a percentage of total final consumption.

3) One case only.

Table 29. Sensitivity analysis (price elasticity)--1980 \$ case.1)

| Mtoe (10 ¹³ kcal) | USA | | | Canada | | | OECD Europe | | | Japan | | | TOTAL OECD ²⁾ | | |
|---------------------------------|----------------|----------------|----------------|---------------|---------------|---------------|--------------|--------------|--------------|--------------|--------------|--------------|--------------------------|----------------|----------------|
| | a | 0.5a | 1.5a | a | 0.5a | 1.5a | a | 0.5a | 1.5a | a | 0.5a | 1.5a | a | 0.5a | 1.5a |
| | | | | | | | | | | | | | | | |
| COAL | | | | | | | | | | | | | | | |
| Indigenous | 537.0 | 567.0 | 537.0 | 26.0 | 26.0 | 26.0 | 225.0 | 225.0 | 225.0 | 15.8 | 15.8 | 15.8 | 875.2 | 905.2 | 875.2 |
| Imports | -46.8 | -67.5 | -55.9 | -6.0 | -6.0 | -6.9 | 53.9 | 65.8 | 53.9 | 58.1 | 50.9 | 58.1 | 23.3 | 17.9 | 9.5 |
| Consumption | 490.2 | 499.5 | 481.1 | 19.5 | 20.0 | 19.1 | 280.5 | 280.8 | 278.9 | 69.4 | 66.7 | 73.9 | 898.5 | 923.1 | 884.7 |
| OIL | | | | | | | | | | | | | | | |
| Indigenous | 650.8 | 650.0 | 650.0 | 106.0 | 106.0 | 106.0 | 220.0 | 220.0 | 220.0 | 2.0 | 2.0 | 2.0 | 988.4 | 988.4 | 988.4 |
| Imports | 331.2 | 374.2 | 291.5 | 6.2 | 6.2 | 34.3 | 69.8 | 734.0 | 629.0 | 407.6 | 438.3 | 385.7 | 1,578.5 | 1,578.5 | 1,578.5 |
| Consumption | 981.2 | 1,024.2 | 941.5 | 108.0 | 112.2 | 101.7 | 893.8 | 934.0 | 849.0 | 405.6 | 440.3 | 387.7 | 2,444.8 | 2,576.9 | 2,326.1 |
| NATURAL GAS | | | | | | | | | | | | | | | |
| Indigenous | 541.0 | 541.0 | 541.0 | 76.0 | 76.0 | 76.0 | 228.0 | 228.0 | 228.0 | 1.8 | 1.8 | 1.8 | 866.9 | 866.9 | 866.9 |
| Imports | 58.4 | 60.3 | 53.0 | -25.1 | -25.1 | -25.1 | 62.0 | 62.0 | 62.0 | 31.3 | 31.3 | 31.3 | 126.6 | 128.5 | 121.2 |
| Consumption | 599.4 | 601.3 | 594.0 | 50.9 | 50.9 | 50.9 | 290.0 | 290.0 | 290.0 | 33.1 | 33.1 | 33.1 | 993.5 | 995.4 | 988.1 |
| TOTAL PRIMARY ENERGY (TPE) | 2,247.4 | 2,301.6 | 2,193.9 | 220.4 | 225.0 | 213.6 | 1,632.4 | 1,697.0 | 1,580.1 | 576.7 | 601.9 | 552.1 | 4,785.5 | 4,934.1 | 4,648.3 |
| INDIGENOUS SUPPLY (% of TPE) | 1,904.7 (84.7) | 1,934.5 (84.1) | 1,904.5 (86.8) | 249.9 (111.1) | 249.9 (111.1) | 249.9 (117.0) | 835.2 (51.2) | 835.2 (49.2) | 835.2 (52.9) | 84.2 (14.6) | 84.2 (14.0) | 84.2 (15.2) | 3,189.1 (66.6) | 3,219.1 (65.2) | 3,189.1 (68.6) |
| IMPORTS (% of TPE) | 342.9 (15.3) | 367.1 (15.9) | 289.4 (13.2) | -29.6 (-13.4) | -24.9 (-11.1) | -36.3 (-17.0) | 797.3 (48.8) | 861.8 (50.8) | 744.9 (47.1) | 492.5 (85.4) | 517.7 (86.0) | 467.9 (84.8) | 1,596.4 (33.4) | 1,715.0 (34.8) | 1,459.2 (31.4) |

1) a = elasticity.

2) No change is assumed for Australia and New Zealand.

into the OECD area, mainly from OPEC countries, fall from 186 Mtoe to 103 Mtoe in 1980, and from 280 Mtoe to 144 Mtoe in 1985.

Tables 30 and 31 show the contributions of the different forms of energy to primary energy requirements in 1972 and for the various cases for 1980 and 1985. Also shown is the percentage share of electricity in final energy consumption. Among the results for the overall OECD area are the following:

- a) In the \$9 cases coal keeps its share of consumption fairly constant, thereby ending a historical downward trend.
- b) The share of oil declines in the \$6 and \$9 cases to just under half of total requirements by 1985.
- c) The share of natural gas remains roughly the same in the \$6 and \$9 cases as in 1972. There is, however, a substantial increase in Europe and a fall in the United States.
- d) The share of nuclear power rises from 1% in 1972 to 13.4% in the \$9 case in 1985.
- e) Electricity increases its share of final energy consumption in the \$9 cases because of lower total final energy consumption.

Sensitivity Analysis

A number of tests were carried out to examine the sensitivity of some of the projections to changes in various assumptions. One of the most important variables estimated is the level of oil imports into the OECD area, and it is believed to be one of the most sensitive variables since it was calculated as a residual. The tests described below were designed primarily to assess the uncertainties surrounding the oil import estimates. The following discussion is confined to reporting the results for changes on the demand side.

1) Demand Elasticities

First the effects of varying the demand elasticities for each sector separately are examined. If the elasticities for gasoline throughout the OECD area are reduced by 50% the reduction in gasoline consumption is slightly greater than 50% of the original reduction in each of the \$6 and \$9 cases, for the prices, quantities and elasticity values relevant here. The extra quantity of oil needed is obtained by increasing OECD oil imports by the same amount. Halving of all gasoline elasticities causes an increase in OECD oil imports of 12.6 Mtoe in the \$6 case for 1980 (9%), and 23.2 Mtoe for \$9 cases (2.1%). The results for 1985 are similar. The changes are small because the relative increases in gasoline prices are small, although the absolute increases are as large as for other oil products.

The analysis is the same for the other elasticities applicable to oil products alone, namely those for transportation fuels other than gasoline, for non-energy oil, and for energy sector consumption of oil. The changes are small in spite of relatively large price increases because the base consumption estimates and the elasticities are all small.

Halving of the industrial elasticities increases OECD oil imports by 70.9 Mtoe (4.9%) in the \$6 case for 1980 and 109.8 Mtoe (10.1%) in the \$9 case. The corresponding results for the residential/commercial sector are 27.8 Mtoe (1.9%) and 48.5 Mtoe (4.5%) respectively. These changes are large because the base quantities, the relative price increases, and the elasticities are all large. But in addition the increase in electricity consumption caused by the elasticity changes entails an increase in primary fuels used to generate electricity about three times as large.

Increases in elasticities by the same absolute amounts would have the same quantitative effects on oil imports in nearly all cases. Exceptions concern the industrial and residential/commercial elasticities in the \$9 cases. Since oil consumption in these cases had already been reduced to very low levels, not all of the reduced energy requirements would take the form of reduced oil imports. A portion would take the form of reductions in other energy consumed.

A halving of the elasticities applied to fossil fuels consumed in electric generation in 1985 would increase primary energy requirements, mostly in the United States, by 21.7 Mtoe in the \$6 case and 29.0 Mtoe in the \$9 case. These additional requirements could be predominantly or completely fulfilled by increased coal use without needing to resort to increased oil imports. By the same reasoning, an increase in elasticities would not reduce oil imports significantly. For 1980 zero elasticities were assumed for all regions except OECD Europe, where a coefficient of 0.1 was applied. If elasticities as large as those employed for 1985 were applied to the 1980 projections, there would be a reduction in primary energy requirements of less than 50 Mtoe and a much smaller reduction in oil imports.

In the preceding analysis the elasticities for each sector were varied separately and the effects on oil imports estimated. The next step is to consider the effect of simultaneous variation of all the elasticity coefficients.

Tables 29 and 30 show the effects of using demand elasticities 50% less and 50% greater than those used in the 1980 \$6 and \$9 cases. Substitution of fuels was held to limits considered reasonable. The only variation made in indigenous supplies of energy as a result of the changed elasticities was for coal in the United States. OECD oil imports are

Table 30. Sensitivity analysis (price elasticity)--1980 \$9 case. 1)

| Ktce (10 ¹³ kcal) | USA | | | Canada | | | OECD Europe | | | Japan | | | TOTAL OECD ²⁾ | | | |
|---------------------------------|---------|---------|---------|---------|---------|---------|-------------|---------|---------|--------|--------|--------|--------------------------|---------|---------|--|
| | a | 0.5a | | a | 0.5a | | a | 0.5a | | a | 0.5a | | a | 0.5a | | |
| | | 1.5a | 1.5a | | 1.5a | 1.5a | | 1.5a | 1.5a | | 1.5a | | | | | |
| COAL | | | | | | | | | | | | | | | | |
| Indigenous | 537.0 | 567.0 | 527.0 | 26.0 | 26.0 | 26.0 | 230.0 | 230.0 | 230.0 | 15.8 | 15.8 | 15.8 | 880.2 | 910.2 | 870.2 | |
| Imports | -64.9 | -81.6 | -67.9 | -7.1 | -6.2 | -8.0 | 50.7 | 70.4 | 50.7 | 54.7 | 50.0 | 50.0 | 9.7 | 10.6 | -7.7 | |
| Consumption | 472.1 | 485.4 | 459.1 | 18.9 | 19.8 | 18.0 | 289.5 | 300.4 | 280.7 | 70.5 | 65.8 | 65.8 | 889.9 | 920.8 | 862.5 | |
| OIL | | | | | | | | | | | | | | | | |
| Indigenous | 719.0 | 719.0 | 719.0 | 111.0 | 111.0 | 111.0 | 236.0 | 236.0 | 236.0 | 3.0 | 3.0 | 3.0 | 1,089.4 | 1,089.4 | 1,089.4 | |
| Imports | 140.8 | 188.5 | 88.0 | -9.4 | -11.9 | -14.8 | 546.8 | 645.2 | 448.0 | 38.0 | 38.0 | 38.0 | 1,032.0 | 1,032.0 | 1,032.0 | |
| Consumption | 859.8 | 907.5 | 807.2 | 101.6 | 109.1 | 96.8 | 790.8 | 881.2 | 704.8 | 385.4 | 425.4 | 425.4 | 2,121.4 | 2,121.4 | 2,121.4 | |
| NATURAL GAS | | | | | | | | | | | | | | | | |
| Indigenous | 613.0 | 613.0 | 613.0 | 92.0 | 92.0 | 92.0 | 255.0 | 255.0 | 255.0 | 3.0 | 3.0 | 3.0 | 983.0 | 983.0 | 983.0 | |
| Imports | 42.2 | 78.7 | 15.4 | -44.0 | -49.7 | -49.7 | 74.0 | 74.0 | 74.0 | 31.0 | 31.0 | 31.0 | 103.2 | 139.6 | 70.7 | |
| Consumption | 655.2 | 691.7 | 628.4 | 48.0 | 47.9 | 42.3 | 329.0 | 329.0 | 329.0 | 34.0 | 34.0 | 34.0 | 1,086.3 | 1,122.6 | 1,053.7 | |
| TOTAL PRIMARY ENERGY (TPE) | 2,163.6 | 2,261.2 | 2,071.1 | 211.5 | 219.8 | 197.1 | 1,561.5 | 1,669.9 | 1,476.7 | 554.5 | 600.3 | 513.3 | 4,599.7 | 4,859.8 | 4,366.8 | |
| INDIGENOUS SUPPLY (% of TPE) | 2,045.5 | 2,075.5 | 2,035.5 | 271.9 | 271.9 | 271.9 | 883.2 | 883.2 | 883.2 | 82.4 | 82.4 | 82.4 | 3,402.3 | 3,428.3 | 3,388.3 | |
| IMPORTS (% of TPE) | 118.1 | 185.7 | 35.7 | -60.4 | -52.1 | -74.8 | 678.3 | 786.7 | 593.5 | 468.1 | 517.9 | 430.9 | 1,197.4 | 1,431.5 | 978.5 | |
| | (5.5) | (8.2) | (1.7) | (-28.6) | (-23.7) | (-38.0) | (43.4) | (47.1) | (40.2) | (84.4) | (86.3) | (83.9) | (26.0) | (29.5) | (22.4) | |

1) a = elasticity.

2) No change is assumed for Australia and New Zealand.

highest in the \$6 case with lower elasticities, reaching 1578.5 Mtoe. In this case total primary energy requirements are reduced only 2.6% from the base projection. It is significant that in \$9 case a 50% reduction in all elasticities still leaves oil imports below the 1973 level of 1292.5 Mtoe.

2) Gross Domestic Product

For reasons discussed above 1980 GDP's could diverge significantly from those assumed in the projections. It is particularly useful to estimate the effects of slower GDP growth on energy consumption and oil imports in 1980. If GDP levels in all OECD countries were 5% lower in 1980 than assumed in the projections, corresponding to a reduction in annual growth from 1972 of approximately 0.7%, total primary energy requirements would be 4.9% less in all three cases. The effects on oil imports are shown in Table 31.

Table 31. OECD oil imports in 1980 with 5% lower GDP's.

| | <u>Mtoe</u> | <u>Per Cent Change</u> |
|-----------|-------------|------------------------|
| Base Case | 1,806.3 | -10.3 |
| \$6 Case | 1,285.6 | -11.1 |
| \$9 Case | 995.5 | - 8.2 |

Reductions in oil import requirements are not as large as they might be expected to be. The reasons are that in some cases the reduction in overall energy demand implies lower indigenous production levels, since some of the available supplies can no longer find markets, and that substitution of oil by other fuels in industrial and residential/commercial uses was limited in some regions to the amounts given in the \$9 reference projections. It is for the latter reason that the percentage reduction in oil imports in the \$9 case caused by the lower GDP level is smaller than those of the base and \$6 cases.

3) Elasticities and GDP

When several assumptions are changed simultaneously the effects may sometimes cancel out. For example, if the chosen elasticities are too high but the GDP growth assumptions are over-optimistic, the 1980 oil imports in the revised \$6 and \$9 projections could end up very close to those of the reference projections, as may be deduced from Figure 1. If on the other hand, the chosen price elasticities are too low, and at the same time the assumed GDP level of the OECD area in 1980 is too high, oil imports could turn out to be very much lower than in the reference projections, bringing them well below 1,000 Mtoe.

It is impossible to assign probabilities to these various combinations of variables influencing future OECD oil imports. However, if the supply estimates (not considered here) are not too high, there is good reason to expect that for prices in the \$6 and \$9 range (in 1972 dollars) OECD oil import levels by 1980 will be less than 1973 levels.

Conclusion

The approach used in the OECD study was mainly a judgmental one, combined with sensitivity analysis of some of the important assumptions. At the same time an attempt was made to structure the projections in considerable detail in terms of a rough conception of an economic model assuming competitive conditions. Given the uncertainties surrounding the estimates the projections may have been developed in too much detail. An argument for such a detailed approach, however, is that it permits greater understanding of the problems involved including the uncertainties and it helps to identify the information needed for an improved analysis.

A truly adequate approach would require scientific estimation not just of price elasticities and other variables in

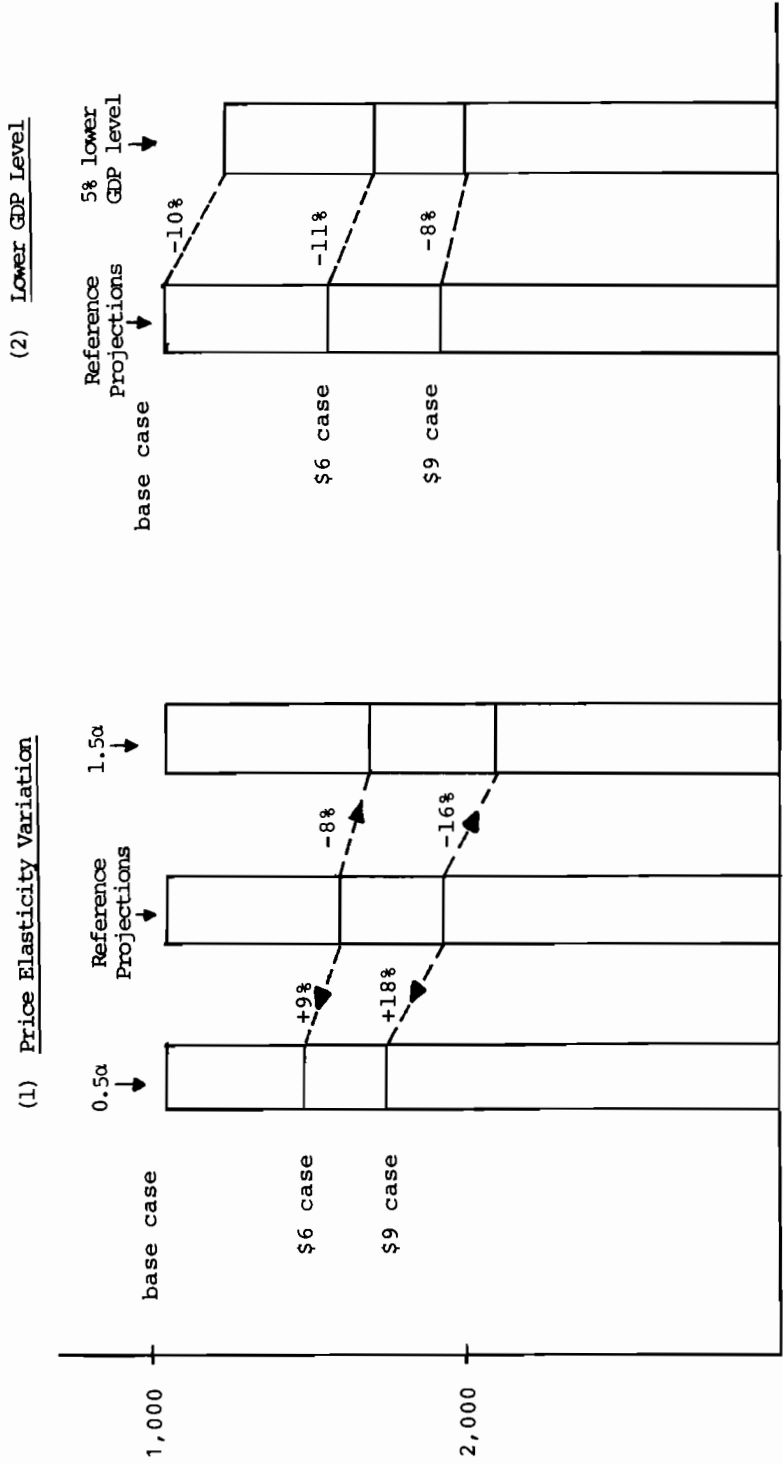

Figure 1. Effect on OECD oil imports of variation in assumed price elasticity of demand and of a 5% lower GDP in 1980.

demand and supply functions. It would be necessary also to develop a model of the international energy industry in order to determine energy prices. Furthermore, for price changes of the magnitudes considered here it is not sufficient to treat the energy industry by means of partial equilibrium analysis. The large increases in energy prices which have occurred since 1973 are likely to have significant effects on economic production in general which in turn will have feedback effects on energy consumption. An analysis which attempts to grapple seriously with all of these problems would be very ambitious.

APPENDIX AExplanatory Notes on the Regional Energy Balances

The total primary energy requirements (TPE) are made up of indigenous supply, net imports, and stock changes in the 1972 energy balances. The oil column includes natural gas liquids.

In the "Electricity Generations" row, the gross electricity produced (including power stations' own consumption) appears as a negative quantity and the figure in the "Total" column is the overall waste heat. In cases where there is production of synthetic oil or gas, the treatment is similar to that for electricity generation, with conversion losses appearing in the "Total" column.

The "Energy Sector and Losses" row is basically the primary energy use by energy-producing industries (except electricity generation), plus the energy loss in production, conversion and transportation of fuels. Included here are the coal mines' own use of coal, conversion loss in coking and production of blast furnace and coke oven gas, oil refineries' own use and losses, natural gas production loss and transportation use (pipeline compressor use of gas), electricity generation plants' own consumption of electricity and all electricity transmission losses.

The "Industry" row contains the fuel and electricity consumption of industry. Note that the use of coke oven and blast furnace gas by the iron and steel industry as well as manufactured gas production appears in the form of a solid fuel input and not as gas. Non-energy use of gas is included here but non-energy oil appears separately in the last row.

The "Transportation" sector includes all forms of transportation as well as ships' bunkers. The "Residential/Commercial"

row covers, in addition to energy demand by households and office buildings, a number of minor sectors such as street lighting, agriculture, etc.

Each entry in the country or regional energy balance tables for 1980 and 1985 consists of three numbers. The uppermost number corresponds to the base case, the middle number is that for the \$6 case, and the bottom number that for the \$9 case. This form of presentation allows easy comparison of the effects of price on the consumption by fuel and by sector. Sectoral and fuel totals may contain minor discrepancies due to rounding.

APPENDIX BConversion Factors

The methodology used in the OECD study involved converting the physical quantities of fuel used into equivalent heat units. Quantities of different forms of energy are expressed in units of 10^{13} kilocalories, (3.968×10^{13} BTU,) referred to as millions of tons of oil equivalent (Mtoe). It should be noted that one Mtoe is only approximately equal to the heat content of one million metric tons of crude oil.

| | | |
|---|---|---|
| a) <u>Solids</u> | <u>Toe/metric ton</u> | |
| Hard coal, (anthracite and bituminous) | | 0.7 |
| Lignite | | 0.2 |
| b) <u>Oil</u> | <u>bbls/metric ton</u> | <u>tons of oil equivalent/metric ton</u> |
| Crude oil | 7.30 | 1.034 |
| LPG | 11.80 | 1.195 |
| Gasoline | 8.53 | 1.128 |
| Jet Fuel | 7.93 | 1.133 |
| Gas/Diesel (distillate) fuel oil | 7.46 | 1.095 |
| Residual Fuel Oil | 6.66 | 1.055 |
| c) <u>Natural Gas</u> | <u>Mtoe/10⁹ cubic meters</u> | <u>Mtoe/10⁶ cubic feet</u> |
| North America | 0.9 | 25.5 |
| Other Regions | 0.84 | 23.7 |

d) Primary Electricity

(Equivalent primary energy input)

| | Mtoe/net Twh ⁶⁾ | Mtoe/gross Twh ⁶⁾ | Effective Efficiency to Net Generation |
|----------------------|----------------------------|------------------------------|--|
| Nuclear | 0.2606 | 0.2436 | 33% |
| Hydro and geothermal | 0.1075 | 0.1064 | 80% |

e) Electricity in Final Consumption

$$1 \text{ Terawatt-hours} = 10^9 \text{ kilowatt-hours} \\ = 0.086 \text{ Mtoe.}$$

Two useful approximations are:

- a) 1 million barrels per day of oil is approximately equivalent to fifty Mtoe per year.
- b) 1 trillion cubic feet of natural gas is approximately twenty-five Mtoe.

⁶⁾Gross electricity includes generating plant's own consumption, net generation is the output from the plant. Consumption by the generating plant is assumed to be 6% of net electricity output for fossil fuel plants, 7% for nuclear plants and 1% for hydroelectric and geothermal generating stations.

International Comparisons of Energy Consumption
Related to Gross National Product

E. Medina

The work undertaken by the Centre d'Etudes Régionales sur l'Economie de l'Energie (Regional Study Center on the Economics of Energy, CEREN) has taken as a starting point that the energy consumption position per GNP unit of France is clearly inferior to that of the other major industrialized countries. In 1971, the energy consumption per GNP dollar was approximately 20% higher in the FRG and Italy than in France, 30% higher in Japan, 50% higher in Belgium and in the Netherlands, 60% higher in the US, and 85% higher in the United Kingdom. The existence of such great differences among countries with fairly close levels of development raises the question of the underlying factors for these differences.

The relevance of this type of question, possibly considered as academic only a few years ago, becomes far more concrete at a point where the accelerated increase in the price of energy stresses the constraining limits on demand, for a market where supply was legitimately considered as practically unlimited throughout the 1960's.

Structure of "Energy Consumption per GNP Unit" Indicator

The choice of GNP as a unit of reference serving to place the consumption level of a given country in an international context is validated both by the fact that it is representative of the overall economic activity of a said country and that it is practically a universally recognized aggregate used as a measuring instrument by most economic observers.

Reference to the GNP is, however, not without certain drawbacks. In fact, its content may not be strictly identical from

one country to another. These divergences might originate either in the conceptual differences concerning the constituents of this aggregate, or in the statistical uncertainties of a more or less marked nature from one country to another.

On the other hand, the comparability of GNP from the international standpoint may be altered owing to the combined influence of two factors:

- 1) the first relates to the difference in the evolution of prices from one country to another;
- 2) the second is linked to the variability of exchange rates between the different currencies and the computation unit chosen to establish the relevant comparisons.

While the expression of GNP in a constant currency that also takes the changes of parity between currencies into account may alleviate the essential part of these drawbacks, some problems remain nonetheless. For example, the differences in method or concept when working out price indexes or the problem of defining fixed parities at a time of floating exchanges remain. While these drawbacks are worth mentioning, they do not jeopardize nor lessen the main conclusions when we pass from a static type analysis to a long-term dynamic analysis.

Overall Analysis

The major advantage of the "energy consumption per GNP unit" indicator probably results from its relative stability in time, plus the fact that the elasticity of the overall energy consumption rate in relation to the GNP is generally close to one. The temporal evolution of the quantity of energy per GNP unit over the 1958-1971 period furthermore stresses the particular position of France and also that of the United Kingdom as well as certain similarities in long-term behavior between countries. In fact, while France is characterized throughout the above period by a remarkably constant unit consumption rate well under that of

other countries, the United Kingdom also stands out, but in a contrary sense.

We also find a generalized acceleration in energy consumption in relation to GNP occurs during the second half of the above period. This trend, which is more or less marked according to the countries involved, follows a period of indicator drop in countries like the FRG and the US. Similarly, the acceleration fits into the context of sustained growth in Italy and in the Netherlands and is the extension of a more stable evolution in France and Japan. These observations find their confirmation in the various elasticities computed from adjustments made according to the following model:

$$\text{Log CE} = a \text{ Log GNP} + b$$

where

CE = primary energy consumption.

These adjustments have produced satisfactory correlation coefficients and Durbin-Watson tests, and therefore confirm the existence of close links between the energy consumption factor and the Gross National Product.

The overestimation of the GNP is among the possible causes that can be considered explanations of relatively low energy consumption per GNP unit factor. In France this is a hypothesis to which the national accountants accord some measure of probability. But on an equal consumption basis, the French GNP would have to be cut at least 20% for the indicator to reach the level of the EEC as a whole. This can be considered as an average although it is the lowest after France. The size of an eventual overestimate of the French GNP would hardly exceed 5%. In addition, the position of France in terms of the per capita energy consumption factor effectively confirms the existence of an underconsumption of energy in relation to the main industrialized countries, even if the French demographic

reference indicator no longer is the last in line and is ahead of Japan and Italy.

The problem now is to know whether this state of affairs is attributable to a time lag in the French economy, to a more efficient utilization of energy resources, or to a different consumption structure making it possible to form a GNP unit from lower quantities of energy than in other countries. Although it serves to define the nature of the problem, an overall analysis is, however, insufficient to indicate the origin of differences between countries. Applying a sectorial analysis now proves indispensable. It has been possible to make this type of analysis only with the six founder countries of the European Economic Community, with the abundant statistical material available, and, to a limited extent, with the United Kingdom.

Sectoral Analysis Methodology

Structure Effect and Specificity Effect

Ranging from the notion of primary energy to that of final energy consumption, it is possible to apportion the final energy consumption/GNP ratio among three sectoral rates by breaking down the economy into three main sectors, Industry (i), Domestic and Tertiary (d), and Transport (t). By the national accounts identity, we have

$$\frac{CF}{GNP} = \frac{CF_i}{GNP} + \frac{CF_d}{GNP} + \frac{CF_t}{GNP} \quad (1)$$

While this breakdown serves to detect the sectoral origins of gaps between countries, it hardly explains the related original factors. Since the sectoral indicators are linked to the size of the sector's consumption relative to the overall consumption, they are insufficient to bring out the specific levels of consumption for each sector. In fact, the energy consumption of a given sector per GNP unit is the product of the overall consumption per unit GNP and the relative share of the sector in the overall consumption:

$$\frac{CF_x}{GNP} = \frac{CF_x}{CF} \cdot \frac{CF}{GNP} \cdot$$

We must therefore rely on an indicator more directly linked to the economic activity of a sector than GNP is.

By introducing (as a sectoral indicator), the value added by industry (VA_i), it is possible to divide the "energy consumption of industry per GNP unit" (CF_i/GNP) into two components:

$$\frac{CF_i}{GNP} = \frac{CF_i}{VA_i} \cdot \frac{VA_i}{GNP} \cdot \quad (2)$$

\swarrow
 specific
effect

\searrow
 structural
effect

The first term expresses the industrial energy consumption per unit value added and may be considered as a "specific consumption of the sector" (CF_i/VA_i). Therefore, we can entitle it "specific effect." The second term measures the share of industrial value added in the GNP ($\frac{VA_i}{GNP}$) and can be interpreted as the size of the sector relative to general economic activity. This component can be called the "structure effect."

The respective value of these two factors serves to determine which of the two effects preponderates in the gaps separating the industrial consumption of energy per GNP unit between France and the other countries.

If industry is analyzed as N branches consuming an individual quantity of energy equalling CF_{in} with $CF_i = \sum_{n=1}^N CF_{in}$, it is possible to make a finer analysis by taking the added value of each branch as an economic indicator:

$$VA_{in} \text{ with } VA_i = \sum_{n=1}^N VA_{in}$$

$$\frac{CF_i}{VA_i} = \left(\frac{CF_{i1}}{VA_{i1}} \cdot \frac{VA_{i1}}{VA_i} \right) + \dots + \left(\frac{CF_{in}}{VA_{in}} \cdot \frac{VA_{in}}{VA_i} \right)$$

An analysis following the same pattern can be applied to the domestic sector $\frac{CFd}{GNP}$. The specific consumption of this sector is defined in relation to the private consumption unit

$$\frac{CFd}{GNP} = \frac{CFd}{CP} \cdot \frac{CP}{GNP}$$

where

CP = private consumption.¹

For the transportation sector, as defined in the energy reports, it is not possible to find a reasonable economic indicator (through a classic national bookkeeping indicator) as was done with the value added for the "industry" sector and with private consumption for the "domestic and tertiary" sector. For this particular sector, which in any case represents only about 15% of the total energy consumption, the idea of implementing an analysis of the type used for the two others was abandoned.

For each of the sectorial gaps, it is then possible to distinguish (as regards the industrial and domestic sectors), between the share of the gap due to the "specific effect" and that due to the "structural effect."

¹Failing an economic aggregate figure representative of the domestic and tertiary sector as a whole the private consumption of households was adopted for two reasons: the energy consumption of households represents the major share of the overall consumption of the domestic and tertiary sector on the one hand; and on the other hand the consumption of the other subsectors (tertiary, agriculture, etc.) can be considered as induced in part by the standard of living of households.

Taking the example of industry between the Federal Republic of Germany (G) and France (F) and according to equation (2):

$$\Delta_i = \left[\frac{CF_i}{GNP} \right]_G - \left[\frac{CF_i}{GNP} \right]_F = \left[\frac{CF_i}{VA_i} \cdot \frac{VA_i}{GNP} \right]_G - \left[\frac{CF_i}{VA_i} \cdot \frac{VA_i}{GNP} \right]_F$$

With Δ_i being the result of the end difference between two products, we can write²

$$\Delta_i = \Delta_i^u + \Delta_i^s$$

where

Δ_i^u = difference due to "specific effect"

$$= \frac{1}{2} \left[\frac{(CF_i)}{VA_iG} + \frac{(CF_i)}{VA_iF} \right] \left[\frac{(VA_i)}{GNPG} - \frac{(VA_i)}{GNPF} \right]$$

and

Δ_i^s = difference due to "structural effect"

$$= \frac{1}{2} \left[\frac{(VA_i)}{GNPG} + \frac{(VA_i)}{GNPF} \right] \left[\frac{(CF_i)}{VA_iG} - \frac{(CF_i)}{VA_iF} \right]$$

$$\begin{aligned} {}^2\Delta(pq) &= p\Delta q + q\Delta p + \Delta p\Delta q = (p\Delta q + \frac{\Delta p\Delta q}{2}) + (q\Delta p + \frac{\Delta p\Delta q}{2}) \\ &= \left[\frac{p + (p + \Delta p)}{2} \right] \Delta q + \left[\frac{q + (q + \Delta q)}{2} \right] \Delta p \end{aligned}$$

where

$$\begin{aligned} p &= \frac{(CE_i)}{VA_i}_F & q &= \frac{(VA_i)}{GNP}_F \\ p + \Delta p &= \frac{(CE_i)}{VA_i}_G & q + \Delta q &= \frac{(CE_i)}{VA_i}_G \end{aligned}$$

Main Results

The sectoral consumptions³ do not include losses due to transformation or to transportation. Their insignificance in relation to overall consumption is such that they have practically no effect on these differences as defined.

1) Energy Sector

The special character of consumption intended for the extraction of fuels and their transformation explains why this sector is generally the object of a separate analysis in relation to other sectors.

The production of electricity from combustible fuels at present is one of the most important channels for the transformation of energy. The output figures of power plants show a constant increase in all countries. This factor has certainly contributed toward the drop in energy consumption noted up to 1965-1966 in many countries. The slowing down of this trend at the end of the concerned period presumably means that the maximum possibility is at hand, especially in France and in Italy where the output of power plants is consistently higher than in other countries. Having more modern heat production equipment than other countries is probably the main reason for this.

The position on the United Kingdom is characteristic in this regard: with all its power plants where coal still plays an important role the UK consumes 18% more fuel on an average than France or Italy. The difference with Luxembourg is 45%.

The differing output figures of power plants produce consumption differences both from the physical standpoint and from the bookkeeping standpoint (energy balances). In fact, the fuel-electricity equivalence factors, calculated on the basis of the power plant output figures, lead to an underevaluation

³This means the sectoral breakdown adopted by the Statistical Office of the European Communities.

of primary electricity (hydraulic and nuclear) in the tce⁴ report of a country with high output in relation to a country with lower output.

2) Non-Energy Consumption

The increasing use of non-energy applications reflects the development of chemistry, mostly from oil products, and natural gas, and constitutes one of the factors which, in recent years, has contributed toward the increase of energy consumption figures per GNP unit.

The volume of such use in the Netherlands (28% yearly increase on an average, between 1960 and 1971 and 11% of the total energy consumption in 1971) partly explains the gap between this country and France (mean yearly increase of 12% in 1960 and 1971; and 6% in overall energy consumption in 1971).

3) End Consumption by Sector

The major part of the differences separating the energy consumption figures per GNP unit are found, however, in the context of the end consumption figures of the three main sectors previously defined, and the sectorial breakdown of said differences makes it possible to establish that the down-on-line position of France recurs systematically in all three sectors.

In spite of the relatively increasing energy consumption demands of the domestic and tertiary sector, industry is the sector affecting the above differences most, except for the Netherlands where the domestic sector is preponderant (see Table 1 and Figures 1 and 2).

By dissociating the "structural effect" and the "specific effect" in the related divergences, we see that the latter is the more important with the exception of the FRG.

⁴Tonnes Coal Equivalent.

Table 1. Differences in energy consumption rates per GNP unit for EEC countries in relation to France.

| Countries | France = 1200 tce/10 ⁶ EUR | | Share of Overall Differences Due to Sector (%) | | Structural Effect | | | Percentage Differences in Relation to Overall Due to: | | | |
|-------------|---------------------------------------|----------------------|--|----------|-------------------|-------------------|----------|---|----------|-------|-------|
| | Absolute Differences | Relative Differences | Industry | Domestic | Transportation | Structural Effect | | Specific Effect | | Total | |
| | | | | | | Industry | Domestic | Industry | Domestic | | |
| Italy | + 222 | + 19 | + 97 | - 23 | + 26 | - 49 | + 21 | - 28 | + 145 | - 44 | + 102 |
| The FRG | + 260 | + 22 | + 51 | + 43 | + 7 | + 23 | - 17 | + 7 | + 28 | + 59 | + 86 |
| Netherlands | + 493 | + 41 | + 24 | + 63 | + 14 | - 7 | - 1 | - 8 | + 30 | + 64 | + 95 |
| Belgium | + 665 | + 55 | + 66 | + 29 | + 6 | - 15 | + 2 | - 13 | + 81 | + 227 | + 107 |

Note: tce = Tonnes Coal Equivalent.

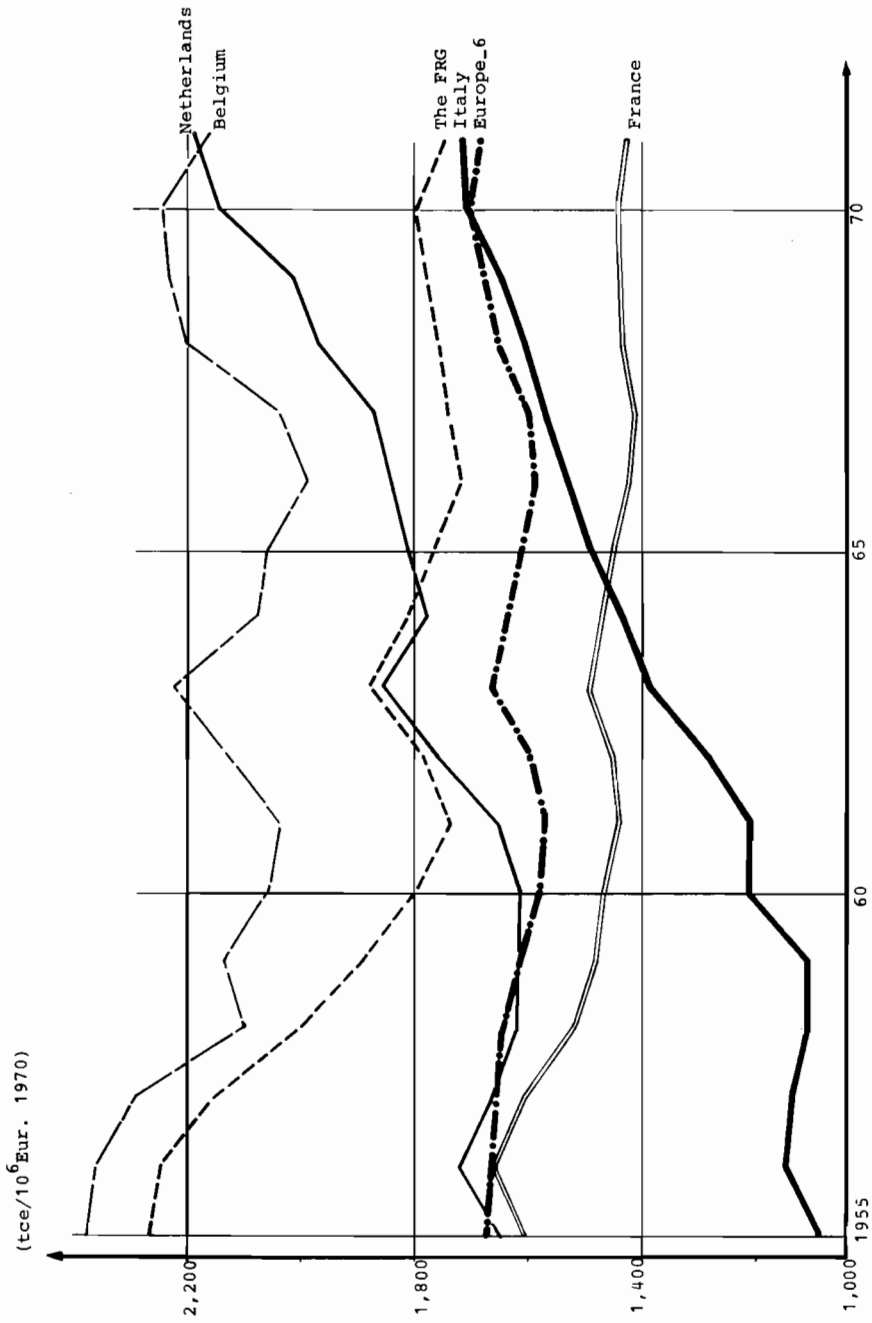

Source: CEREN.

Figure 1. Primary energy consumption per unit of GNP.

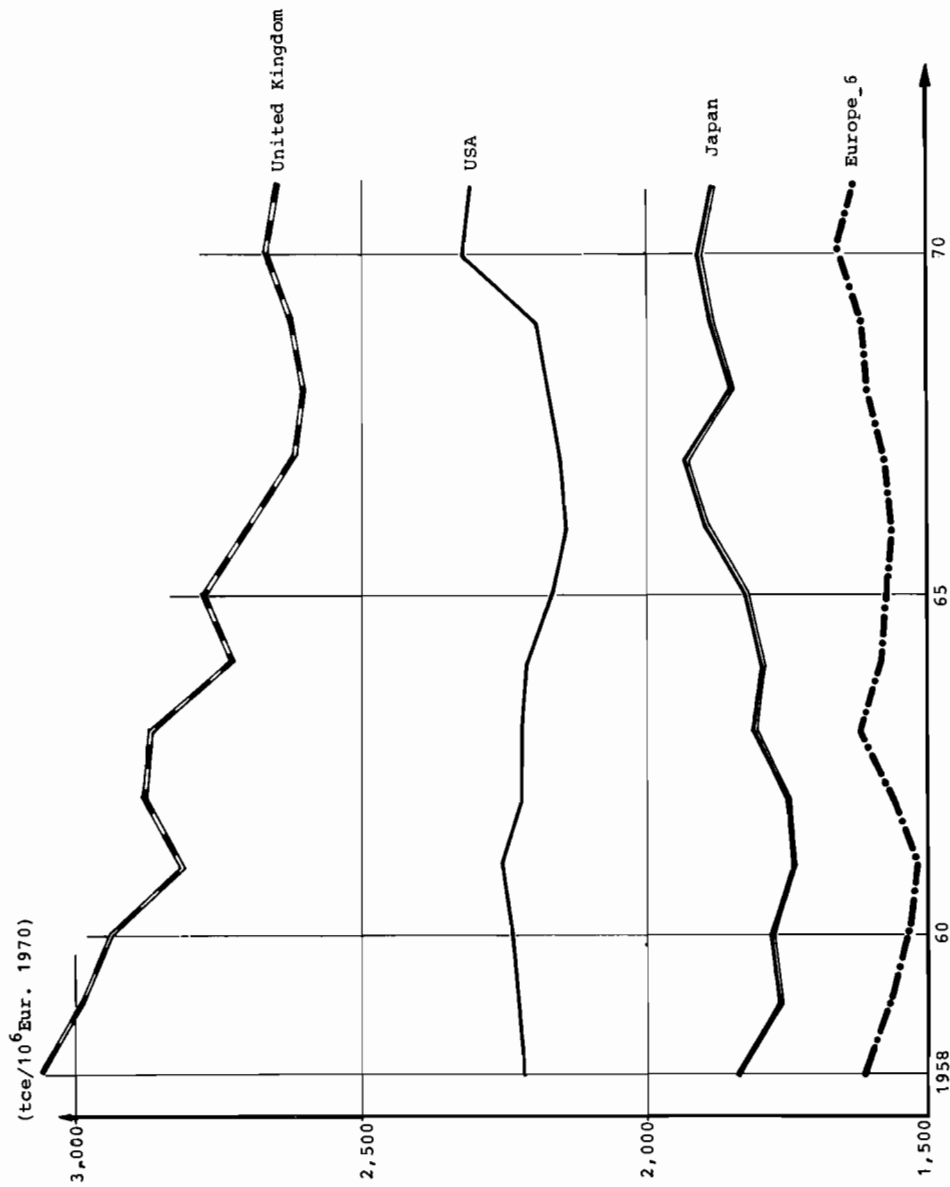

Source: CEREN.

Figure 2. Primary energy consumption per unit of GNP.

In fact, we must look at the specific levels of consumption for the cause of the gaps separating France from other countries. These gaps are to be found more in industry than in the domestic sector for Italy and Belgium, while for the FRG and the Netherlands, the opposite holds true.

3.a) Industrial Sector

The figures for energy consumption in industry have risen far more slowly in the FRG (2.9% yearly between 1958 and 1971) and in France (3.2%) than in Belgium (4.7%) or in the Netherlands or in Italy (7.5%). Thus the quantity of energy needed to constitute an industrial value added unit has dropped by 16% in France between 1965 and 1970 and by 10% in the FRG, while remaining stable in Belgium and the Netherlands and increasing slightly in Italy. The reasons to explain this situation are, first of all, that industrial development in France and the FRG is at a more advanced stage than in Italy. In addition, the size of the first two countries has enabled improved output following industrial concentration and renewal of productive capital which have been more rapid than in smaller countries like Belgium or the Netherlands.

A more detailed analysis by the industrial branch shows that specific figures for consumption are inferior in seven out of ten branches for the FRG, Italy and the Netherlands, and in nine branches for Belgium. Chemistry is the main sector in which France differs from the FRG, Italy and the Netherlands, while for Belgium it is in the steel industry that the difference exists. In Belgium, the importance of the steel sector, linked with coal resources, has probably contributed toward a slower modernization of industrial structures than in France where the evolution of industrial coal prices has encouraged the faster penetration of oil: with 100 as a basis in 1963, the price of industrial coal in relation to fuel oil reached index 167 in France by 1970, but only 120 in Belgium.

3.b) Domestic and Tertiary Sector

All countries, except Italy, have a higher specific consumption rate in this sector (per private consumption unit) than France. We can cite two essential reasons for this: the first is due to the climate factor as concerns power consumption in this sector, the second to a certain degree of underequipment in energy consuming household appliances in France.

The importance of heating, which represents approximately 80% of the energy consumed in this sector, shows the major importance climate can have on the energy consumption rates of a given country. In this regard the consumption peak during the particularly harsh winter of 1962-1963 is clearly visible in the evolution of the overall consumption rates. This peak is in fact far clearer in the FRG, Belgium, the Netherlands and the United Kingdom than in warmer countries like France and especially Italy where this phenomenon is virtually imperceptible.

The elimination of the climate factor in each country in order to measure its exact bearing would require figures on a number of points such as:

- the percentage of energy consumption which each country devotes to heating;
- the temperature limit below which heating is used in each country;
- the resulting room temperature.

Lacking such data for the countries in this survey, it was preferred to fix consumption rates in each country in terms of normal climate conditions in France, rather than to eliminate the climate factor.

These corrections only concerned fuel consumption rates (coal, fuel oil, gas) in the domestic sector, as electric heating is still very limited in most European countries and because the energy consumption for heating industrial premises has developed only in recent years and represents a percentage of consumption rates in his sector which is far lower than that of the domestic and tertiary sector.

Following several tests, the following model was selected for the FRG, France, the Netherlands and Belgium:

$$C + (at + b)DMo + Co$$

where

C is the fuel consumption rate;

Co is the consumption rate of fuels insensitive to temperature;

t is the time;

DMo is the degree months observed.

$$DMo = (S - To);$$

S = temperature threshold (that of France has been adopted for the other countries);

To = monthly temperature observed;
sum over a one-year heating period.

After estimating factors a, b, Co by linear regression for each country, the power consumption rate related to normal French conditions C_N is produced by this formula:

$$C_N = (at + b)DM_n + Co;$$

DM_n = normal degree months;

$$DM_n = (S - T_n);$$

with T_n = normal French monthly temperatures.

For Italy a second degree proportionality factor ($at^2 + bt + c$) has produced more satisfactory results than that of the first degree ($at + b$). Further to these corrections, it was found that the consumption rate divergences in the domestic and tertiary sector per GNP unit was reduced by about 60% between France and the FRG, by 45% between France and Belgium, by 40% between France and the Netherlands. With the exception of Italy, climate therefore stands out as a determining factor in the differences between France and the other countries.

The second factor of underconsumption in France is found in the small portion of electricity in the report relating to this sector, where it represents only 18%, as against 24% in Italy and the FRG and 20% in the Netherlands.

3.c) Transportation Sector

It is in this sector that the relative gap between France and other countries is the smallest. Utilization rate estimates generally stress the more widespread use of rail transportation in France than in other countries. This trend of preference for rail over road transport is perceptible for both the transportation of goods and of passengers. It is well known that from the standpoint of energy consumption rail transport is considerably cheaper than road transport.

Summary

The present paper summarizes the main points of exploratory work undertaken to date by the CEREN--both from the standpoint of methodology and that of results in the domain of international comparisons of energy consumption.

While the particular case of France to date has been the priority focus point of this work, it does not constitute the only center of interest of a comparative analysis of demand on the international level, founded on the relation between power

consumption and GNP. The nature of the evolution of this indicator over a long period, and the measure of its sensitivity to the recent crisis might serve as a foundation for a global forecast methodology which could probably be substantially enriched by the theory of the systems analysis. Sectoral analysis also offers possibilities which are far from exhausted.

All research routes have not been systematically dealt with, as for example the problem relating to the structure of trade balance and its effects on energy balance through the instrumentality of the energy contained in imported or exported products. It is also worth mentioning, that a possible generalization of this approach might be applied to the analysis and prediction of the energy consumption rates in developing countries.

DiscussionHutber

I wonder why we are doing these comparisons. Is it because as a member of a government department we are asked questions from members of the Parliament such as why are we less efficient or more efficient or why do the French have higher efficiency in their electrical system than we do? There is quite a lot of work involved in these analyses, and when we actually do the work, we find that there is not the difference that was thought to be there at the outset. For instance, why do we, in the UK, generate electricity at 30% efficiency and the French at 35%? The answer comes out quite strongly that it has to do with the amount of hydro in the French system. Then when we looked at domestic consumption, we found that the French appliances are exactly the same within tolerable differences, having exactly the same efficiency as the ones used in the UK. The philosophical point is, why do we want to do it?

Charpentier (translating Medina's reply)

The reason this research was undertaken is owing to the peculiar situation in France of "Energy Consumption per Gross National Product Unit." It was interesting to find the reasons why France uses perceptibly less energy per GNP unit than countries with a similar economic development level.

Was it necessary to attribute this to a delay in some sectors, or rather to a more efficient use of energy resources? If the first explanation were held, would it be necessary to expect an overtaking which would go on--in the years to come--in the accumulation of the growth rate of energy consumption between France and other countries? In fact, the reasons are very different: a relative under-equipment in electric domestic appliances, a slighter specific consumption in industry, a milder weather, etc.

Amid these factors, it is fitting to mark a slightly lower consumption for French thermal power stations with regard to other European power stations, except for Italy. This is the conclusion of the statistics published by OSCE, the Statistical Agency of European Communities, and we can see that the production of one thermic kilowatt per hour needs, for example, a quantity of fuel, in gramcoal equivalents, of 320 in France and 378 in the United Kingdom.

Toward A Better Understanding
of Energy Consumption

J.-P. Charpentier

Introduction

For some time now several difficulties--such as the oil crisis, environmental pollution, problems in economic growth--have increasingly emphasized the need for a better knowledge of the linkages between economic and social growth and energy consumption. Research dealing with engineering studies of growth and consumption is becoming more sophisticated, and it is paralleling and complementing econometric approaches to these topics. These studies have three main purposes:

- 1) to avoid as much as possible the idea of price; price is, as we have recently seen, more the consequence of political decisions than market forces;
- 2) to look carefully at the physical boundaries of the economic development; and
- 3) to supply the necessary knowledge for differential studies between the present situation and some modification in the fixed economic sectors.

The goal of our study is to provide the methodology with which to answer the following question: "what are the consequences for human welfare of living with 2 or 7 or 10 or 20 kw per capita?"

Different standard groups of consumers will be defined. A group has to be taken here in a broad sense, and is closely related to the notion of standard of living. The statistical agencies, for instance, take into account standard groups of

consumer goods and services for estimating the inflation rate, but our group contents will be different; our groups will be related to subsystems as a whole rather than to specific goods. Each group or subsystem will be related to the major final needs of human beings, for example, the housing system, the transport system or the food system, etc. (see Figure 1).

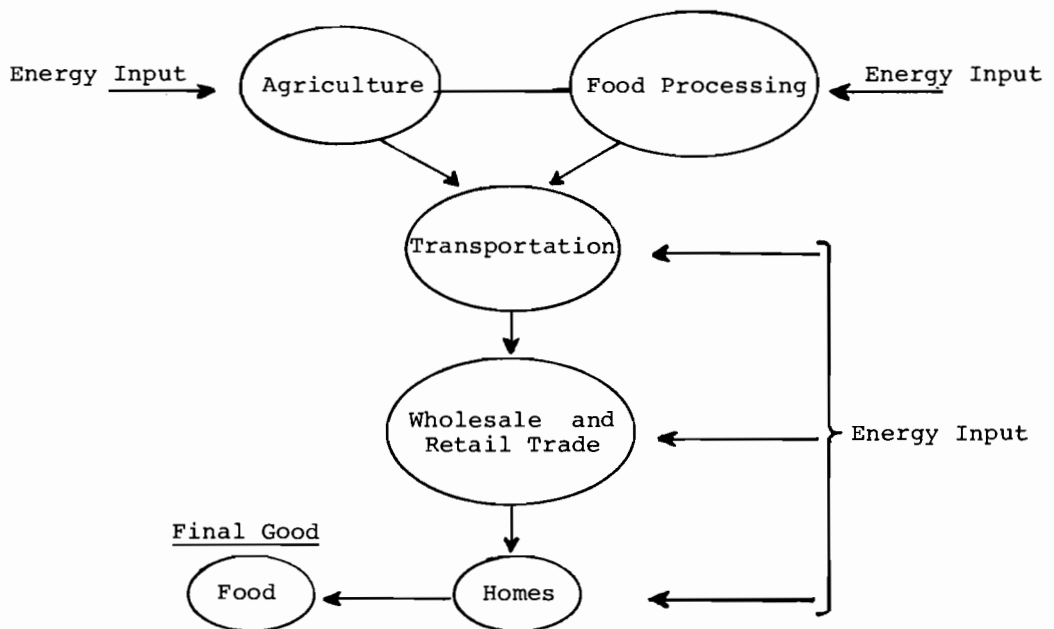

Figure 1. The food system.

The subsystem approach provides a better understanding of energy needs for the most relevant final uses of people, but is difficult to evaluate because the statistical information is currently mixed with the sectors of classical economics: households, agriculture, transportation and industry. In order to avoid any duplication a major effort has to be made for a careful definition of the boundaries of the subsystem.

The subsystems linked to each of the final uses of people will be aggregated later on in order to build normative scenarios. These scenarios could give a rough representation of standard societies.

The qualitative description of such scenarios is essentially done by aggregating the experts' opinions. Two main techniques could essentially be used in this field:

- cross impact matrices which highlight the most relevant parameters, and
- gathering subjective probabilities.

(For more details on this methodology, see Charpentier [10].)

This paper will not deal with the whole subject but only with some basic knowledge needed for feeding the scenarios. Our investigation on this subject proceeds along two lines:

- a) the macro-level: what is the level of energy consumption per capita in the world at the present? Where is this energy used? and
- b) the micro-level: how much energy is needed for supplying specific goods? This could be a basic material such as a ton of steel or a final product such as a nuclear plant. We currently sustain a major effort on this problem which deals essentially with the "energy content" in a product. This will be the basic information for differential scenarios.

Part 1: Study of Energy Consumption at the Macro Level

Before going further I want to emphasize well-known but nevertheless still unsolved difficulties in the energy field; these are:

- the equivalences between the different forms of energy, and
- whether work is performed at the primary or final level.

Throughout our study the adopted unit was:

$$kw_{th} \text{ (or } kw_{y}/\text{year)}$$

at the primary level of energy consumption. Further, the following conversion factors have been used (see Table 1).

Table 1.

| | | | | |
|---------------------------|---|-----------------------------|---|------------------|
| 1 t coal | = | 6.2×10^6 kcal | = | 0.82 kw_{th} |
| 1 t fuel oil | = | 10.0×10^6 kcal | = | 1.32 kw_{th} |
| 10^6 m ³ gas | = | $4\ 200.0 \times 10^6$ kcal | = | 556.00 kw_{th} |
| 10^3 kwh_e | = | 2.2×10^6 kcal | = | 0.29 kw_{th} |

Next, let us recall briefly the different steps for accounting energy (see Figure 2).

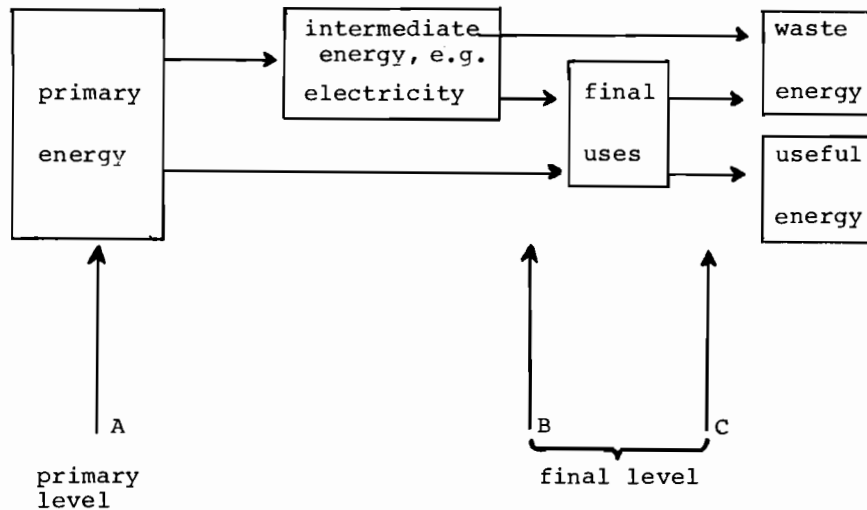

Figure 2.

Despite the fact that everybody knows both of the difficulties above, no consensus has been adopted, and few authors are precise in explaining what coefficient of equivalence they use and what level they work at. This can lead to misunderstandings.

While governments prefer to work with primary energy (level A), which indicates the total amount of energy needed, the final consumer normally calculates only at level B, which corresponds to the amount of energy he buys. (The final consumer is uninterested in losses in energy transport and the efficiency of electric power plants.) Sometimes the final consumer takes into account the efficiency of his own engines (or appliances), and then he evaluates in terms of useful energy at level C.

1.1 Distribution of Energy Consumption in the World

Figure 3 gives the distribution of energy consumption per capita in the different countries of the world (in kwy thermal per year; this distribution is the same using population instead of countries):

- 75% of the countries (which correspond to 72% of population) consumed less than two kw/cap.;
- 22% of the countries consumed between two and seven kw (all European countries are in this group);
- 3% of the countries (essentially the USA and Canada) consume more than 3% of the energy consumed in the world.

This distribution shows that even if the world population were to stop its growth, the increasing consumption of developing countries would continue to increase average world consumption currently around 1.7 kw per capita. (Let us note that this distribution is fitted very well by the addition of the two following statistical distribution laws: Rayleigh and Laplace with the respective coefficients of 0.15 and 0.33.)

Tables 2 and 3 show the average of energy consumption for 1955 and 1970 related to the three kinds of model societies on which normative scenarios are built. Next, Figure 4 is a test

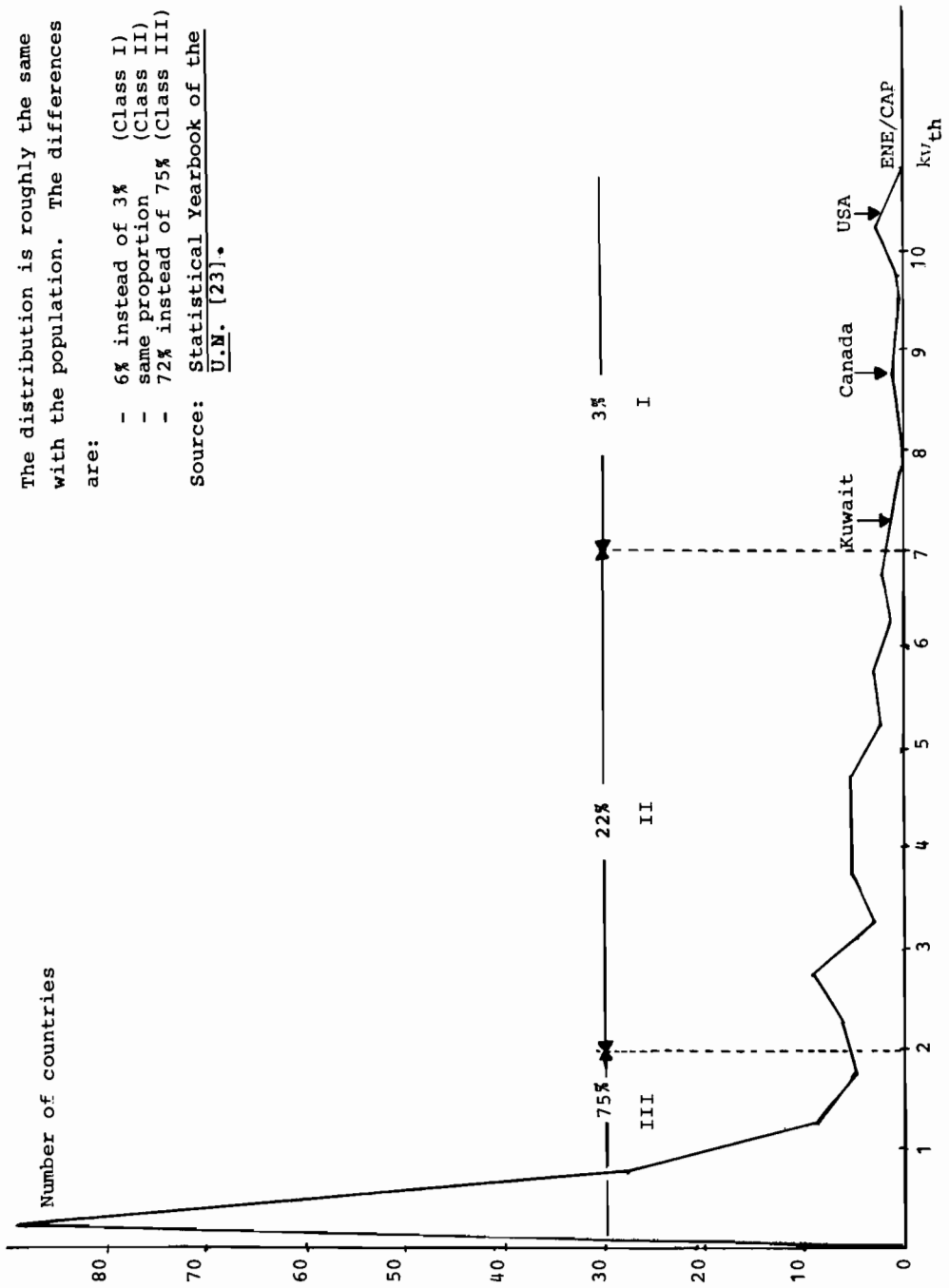

Figure 3. Distribution of world energy consumption (178 countries).

Table 2. Average energy consumption about 1955.

| Class | Energy per capita kw.Y th | Sectors | | | | | | Σ |
|--|---|----------|--------------------|-----------|--------------------|---------------------------------------|--------------------|-----|
| | | Industry | | Transport | | Other sectors household + agriculture | | |
| | | % | kw.Y th | % | kw.Y th | % | kw.Y th | |
| I Upper level of energy consumer (e.g. USA) | E/cap > 7 | 47 | 3.4 | 22 | 1.6 | 31 | 2.2 | 7.2 |
| II Middle level of energy consumer (e.g. Europe, Japan) | 2 < E/cap < 7 | 56 | 2.0 | 13 | 0.4 | 31 | 1.0 | 3.4 |
| III Low level of energy consumer (e.g. developing countries) | E/cap ≤ 2 | 46 | 0.13 | 28 | 0.08 | 26 | 0.09 | 0.3 |

Table 3. Average energy consumption about 1970.

| Class | Energy per capita kw.y th | Sectors | | | | | | | | Σ |
|--|---|----------|--------------------|-----------|--------------------|---------------------------------------|--------------------|--|------|----------|
| | | Industry | | Transport | | Other sectors household + agriculture | | | | |
| | | % | kw.y th | % | kw.y th | % | kw.y th | | | |
| I Upper level of energy consumer (e.g. USA) | E/cap > 7 | 42 | 4.2 | 22 | 2.2 | 36 | 3.6 | | 10 | |
| II Middle level of energy consumer (e.g. Europe, Japan) | 2 < E/cap < 7 | 56 | 2.5 | 14 | 0.6 | 30 | 1.3 | | 4.4 | |
| III Low level of energy consumer (e.g. developing countries) | E/cap \leq 2 | 47 | 0.5 | 29 | 0.3 | 24 | 0.25 | | 1.05 | |

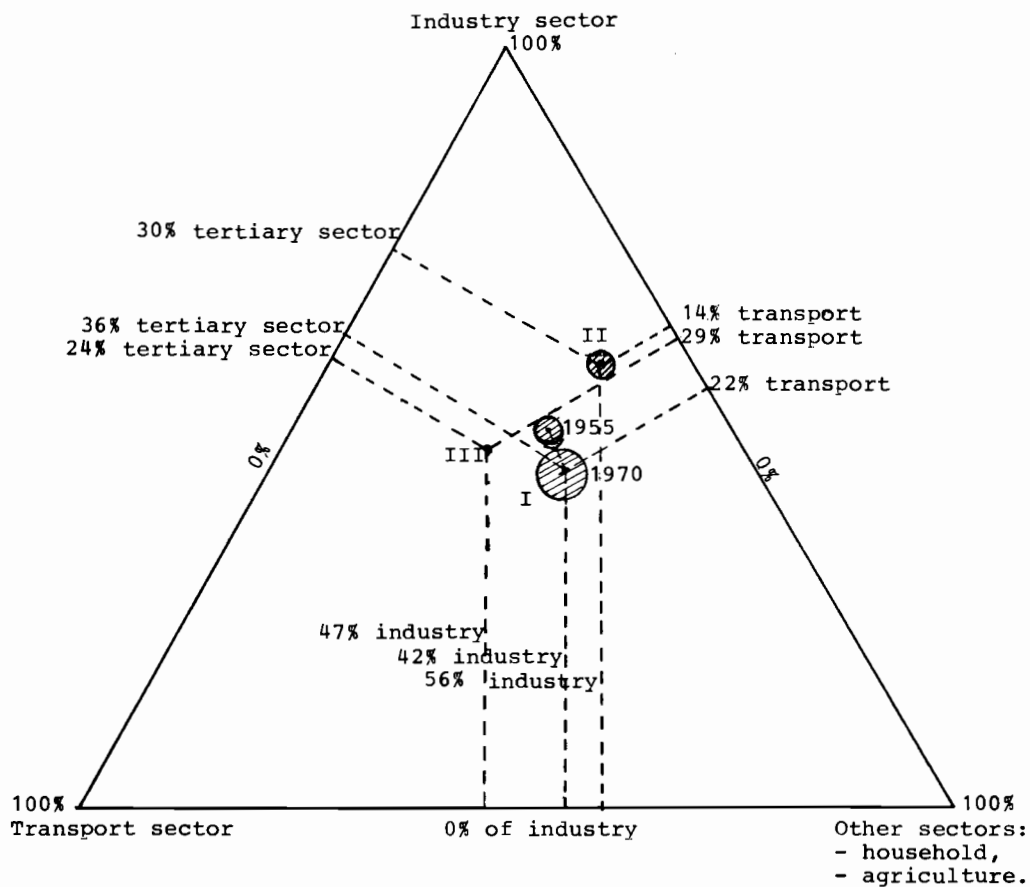

Society I : energy consumption per capita greater than 7 kw_{th}
 Society II : energy consumption per capita between 2 and 7 kw_{th}
 Society III: energy consumption per capita less than 2 kw_{th}

Note: the circles are proportional to energy consumption. The structure of energy consumption does not have to be significantly modified for the countries of type II and III between 1955 and 1970. Only the energy consumption structure society I (high consumer) has significantly modified.

Figure 4. Evolution of the percentage of energy per capita used per sector in different countries in 1955 and 1970.

for looking at the structural evolution of the weight of the three main sectors (industry, household and transport) in the different kinds of economies. In society I energy per capita is greater than seven kw_{th} . In society II energy per capita is between two and seven kw_{th} . Let us note that between 1955 and 1970 only the structure of energy consumption in society I (high consumer) has been significantly modified. The proportion of energy consumed in the transport sector remained the same (22%) but the weight of the industrial sector decreased to the benefit of the other sectors (household, service and agriculture) (see Table 4).

Table 4.

| Society I E/cap > 7 | Industry | | Transport | | Household, Service, Agriculture | |
|------------------------|----------|------|-----------|------|---------------------------------------|------|
| | 1955 | 1979 | 1955 | 1970 | 1955 | 1970 |
| | 47% | 42% | 22% | 22% | 31% | 36% |

In the two other societies (II and III) the structure of energy consumption remained approximately the same (see Table 5).

Table 5.

| | Industry | Transport | Household, Service, Agriculture |
|--------------------------------------|----------|-----------|---------------------------------------|
| Society II $2 < E/\text{cap} < 7$ | 56% | 14% | 30% |
| Society III $E/\text{cap} \leq 2$ | 47% | 29% | 24% |

1.2 Factorial Analysis

The general idea of factorial analysis is to clarify and classify sets of data. Let us take, for example, n different countries, each characterized through a vector of m parameters. The goal of this method will be to extract from this $n \times m$ matrix all the relations that could exist between the parameters and the countries.

If the countries (c_i) were characterized by only two parameters one would have a plot each of them in a two-dimensional space defined by the two parameters, and also be able to see if any mathematic law could link the two parameters m_1 and m_2 (see Figure 5). In this case we would have made a regression analysis.

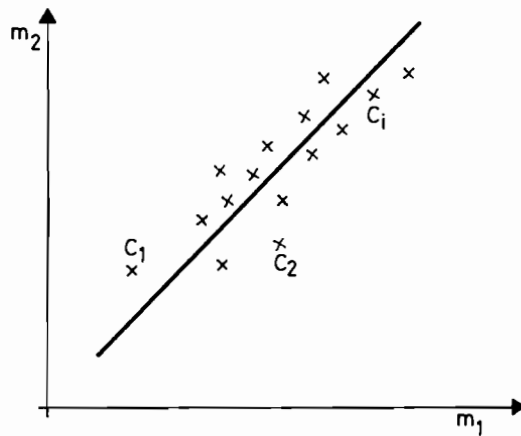

Figure 5.

Now if the countries are characterized by n parameters, we are in a space of n dimensions. The problem is then more complex, but the general idea remains the same: we want to find the different axes which best link this dataset (see Figure 6). The mathematical development of this problem is too large to be shown here; see Benzercı [1]. Let us say only that the method will identify:

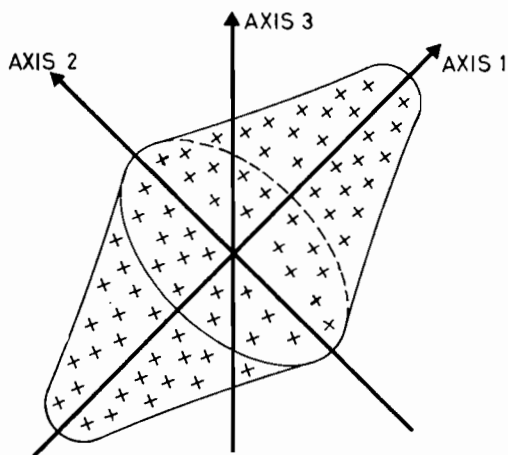

Figure 6.

- 1) which parameters could be linked;
- 2) which countries could be gathered into groups; and
- 3) for each group of countries what kinds of parameters are closely related to it.

The factorial analysis presented takes thirty-four countries into account, each characterized by twenty-seven parameters. The countries have been selected to balance between high, middle, and low energy consumers (see Table 6). Parameters in the following areas (see Table 7) have been selected:

- energy consumption;
- geographical and physical aspects such as density of population, surface of arable area available per capita (in order to separate possible agricultural and industrial countries), reserves of fossil fuel (in order to have an idea of what the country has "in its pocket"), etc.;

Table 6. List of countries.

| | |
|------------------|----------------|
| <u>Europe</u> | <u>America</u> |
| Austria | Argentina |
| Bulgaria | Brazil |
| Denmark | Canada |
| FRG | Mexico |
| France | USA |
| GDR | Venezuela |
| Greece | <u>Africa</u> |
| Hungary | Ivory Coast |
| Italy | Niger |
| Netherlands | Nigeria |
| Portugal | <u>Asia</u> |
| Rumania | China |
| Spain | India |
| Sweden | Indonesia |
| UK | Iraq |
| USSR | Iran |
| Yugoslavia | Israel |
| <u>Australia</u> | Turkey |
| Australia | |

- general economic development. In this case two kinds of parameters may be selected from: either parameters related to the level already reached such as GNP/capita or steel consumption per capita or related to the speed of evolution such as growth rate of GNP/capita, growth rate of population, or growth rate of industrial production, etc.

Table 7. Selected related parameters.

| (1) Energy consumption | (2) Geographical and physical consideration | (3) Economic and sociological aspect |
|--|--|--|
| Energy/capita (1970) Fuel oil/capita (1970) Gas/capita (1970) Electricity/capita (1970) Electric industry/total electricity (1970) | Arable area/total area Population/total area Arable area/population Energy imported/energy consumed (1970) Reserves fossil/capita (1970) | <u>Present level</u> Urban population/rural population Students/population (1970) GNP/capita (1970) Investment ratio Cars/capita (1970) Newspapers/1,000 (1970) Steel/capita (1970) Employment/capita (1970) Cement/capita (1970) t × km transport by rail/capita (1970) t × km transport by plane/capita (1970) <u>Growth rate</u> Decrease rural population (1969-1970) Increase population (1963-1970) Increase industrial production (1969-1970) Increase manufactural production (without mining and energy industry) Increase of production of electricity (1963-1970) Increase GNP/capita (1967-1970) |

Without going into any explication of the method let us only say that:

- a) the already mentioned axes are the eigenvectors of the variance-covariance matrix between the different parameters;
- b) the coordinate of any variable with any of these axes is proportional to the correlation coefficient between the variable and the axis.

Generally one retains the first two eigenvectors and projects both parameters and countries on a graph. (The mathematical equations are symmetrical.)

The gathering of parameters or countries on this graph as well as the fact that the coordinate of any variable (parameter or country) with each axis is proportional to the variable's correlation allows us to interpret the meaning of each axis.

In this study we found:

- the first axis shows 41% of the variance of the information;
- the second 15%;
- the third 11%; and
- the fourth 6%.

We decided to project on the graph (see Figure 7) only that which is defined by the two first axes because the first two projections made on this graph gathered (41% + 15% =) 56% of the total information included in the initial matrix.

1.2.a Interpretation of Axes

In Figure 7, axis 1, which explains 41% of the information contained in the input data, corresponds clearly to an axis of economic development. It shows the high correlation existing between the steel consumption per capita, the electricity consumption per capita, the global energy consumption per

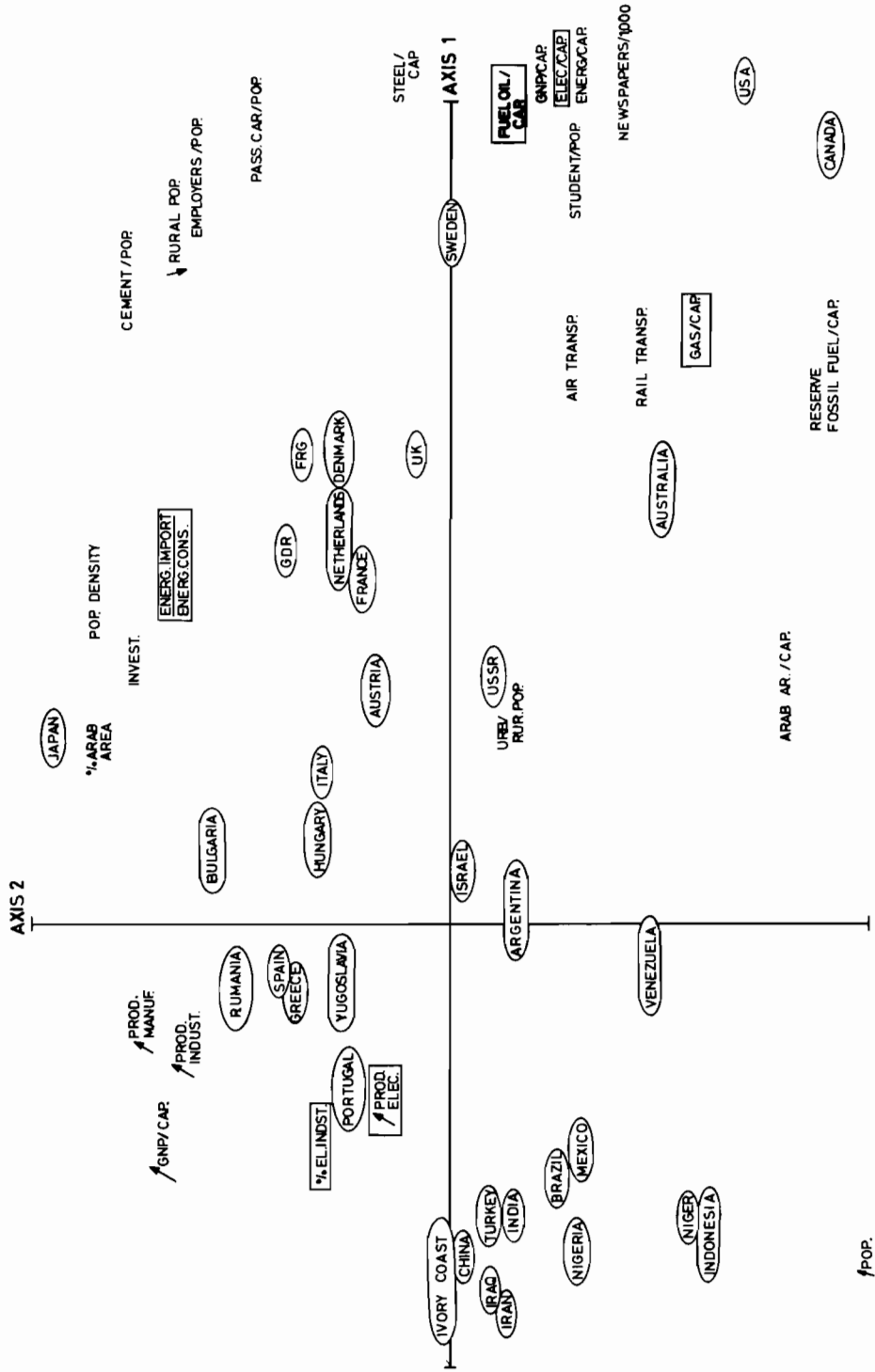

Figure 7. Factorial analysis: energy versus growth (1971).

capita, the number of students per capita, and the number of newspapers and cars. The second axis is related more to the notion of space and population density.

1.2.b Gathering of Countries

The countries in Figure 7 can be divided into three main groups:

- 1) Group one is composed essentially of the USA and Canada and up to a certain extent it also includes Sweden and Australia. These correspond to the most economically developed countries. It is interesting to note that gas consumption is less correlated to the level of development than fuel oil or electricity consumption. The main parameters which characterize these countries are:
 - level of GNP/capita;
 - consumption of energy/capita;
 - consumption of electricity/capita;
 - number of newspapers/1,000;
 - number of students;
 - consumption of steel/capita.
- 2) Group two is composed of almost all European countries (Eastern and Western) plus the USSR, Israel and Argentina. The FRG, the GDR, Denmark, the Netherlands, France, the UK and Austria are very close and are characterized by their level of energy importation and their density of population. Rumania, Spain, Greece, Yugoslavia and Portugal are more characterized by the speed of their economic evolution than by the level obtained. Israel, Argentina and the USSR are located close together, but it is difficult to interpret the reasons. Only the parameter giving the ratio between urban and rural population is nearby.

Japan is clearly defined by its high density of population and the surface of its arable area.

- 3) Group three is composed of developing countries and they are close together. This group, like the last one, is more characterized by its growth rate than by the level it has obtained.

1.2.c Additional Information

This method also provided the correlation matrix of twenty-seven chosen parameters. We selected parameters which had two by two correlation factors greater than 0.75. These are (see Table 8 and Figure 8):

- GNP/capita;
- energy/capita;
- electricity consumption/capita;
- consumption of petroleum products/capita;
- steel production/capita;
- number of passenger-cars/capita;
- electricity/capita;
- number of newspapers/1,000;
- percentage of employers in manufacturing;
- decreasing rate of rural population; and
- increasing rate of population.

If we return to Figure 7, for a moment, we see that most of these parameters are closely related to the high and middle classes of energy consumer countries (more than seven kw per capita and between two and seven). We can conclude that for these two classes any development function has to take into account these twelve parameters. Such analysis is very helpful for locating each country in regard to the aggregation of different parameters and also for cross-sectional comparisons.

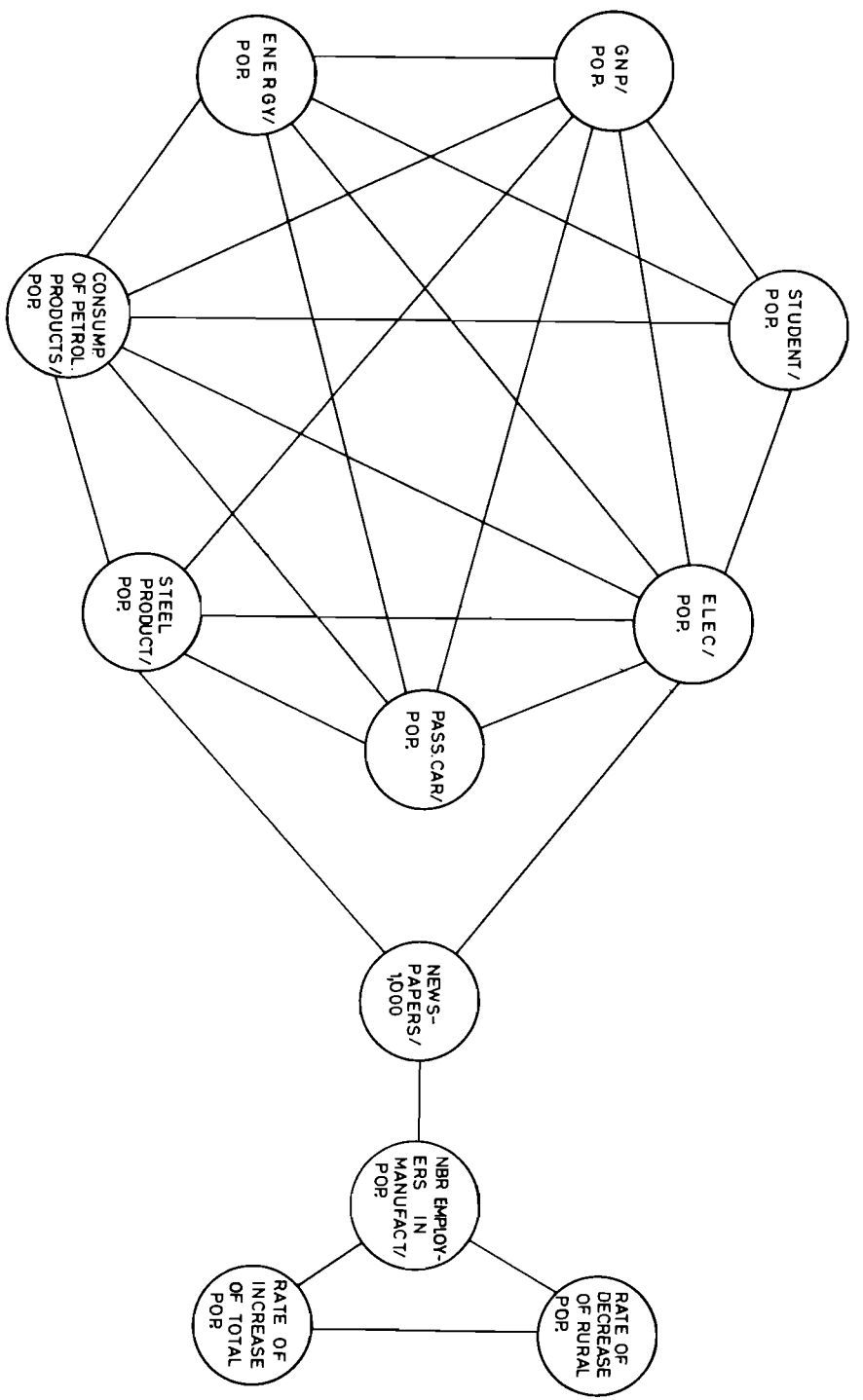

Figure 8. Relationship between energy parameters and other economic parameters (factorial analysis made on cross-section of thirty-seven countries; correlation factor greater than .75).

Part 2: Study of Energy Consumption at the Micro Level

The micro-level work deals essentially with the energy content in a given good and the energy needed for using it. Three kinds of investigations are possible:

- engineering approach or process analysis;
- statistical approach; and
- use of I/O matrices.

2.1 Definitions of Boundaries

For each of these approaches the major difficulty is to define clearly the boundaries of the subsystem studied. If it is not done, and often it is not, huge errors are introduced and it is impossible to make valid comparisons.

Few authors emphasize this fundamental point. Dr. P. F. Chapman from the Open University and Milton Keynes of the UK, have pointed this out in many articles, but the proposal I wish to report, the best in my opinion, was made last summer in the IFIAS Workshop on Energy Analysis in the paper "Guidelines For Energy Analysis" [3]. Here, the authors propose the consideration of a minimum of three levels of a subsystem (see Figure 9):

- level one includes the direct energy input to the final process stage. Evaluation here includes fuel and electric energy supplied to a process. It does not include the energy requirements for prior steps such as the generation of electricity;
- level two includes the inputs both to produce the materials used in the process and to provide the energy used in level one; and
- level three includes the energy requirements for producing capital equipment.

The other useful proposal they made is a standardization of flow diagrams describing production processes like the following one in Figure 10.

Figure 9.

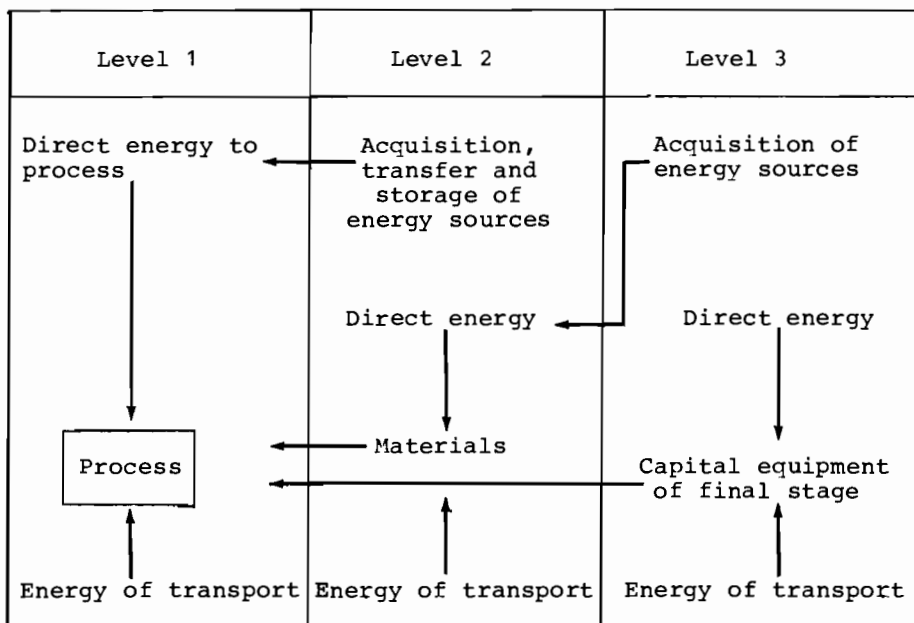

2.2 Engineering Investigation

Right now at the International Institute for Applied Systems Analysis (IIASA), we are engaged with different industrial firms from the Common Market for detailed engineering investigations of energy consumption at the micro level. Of the major final products, only one or two per industrial sector are investigated.

Figure 10 shows an example from the building sector of the method for compiling the information. At the bottom of the diagram the final product is specified, i.e., 1 m^2 of well isolated wall with a thermodynamic coefficient of $k = 0.5 \text{ kcal/m}^2 \cdot \text{h} \cdot ^\circ\text{C}$. (Let us recall that on the average most of the present wall coefficients are close to 1.5.) The total energy need for building such a well isolated wall is 9.2 kWh_e and $99.3 \times 10^3 \text{ kcal per m}^2$.

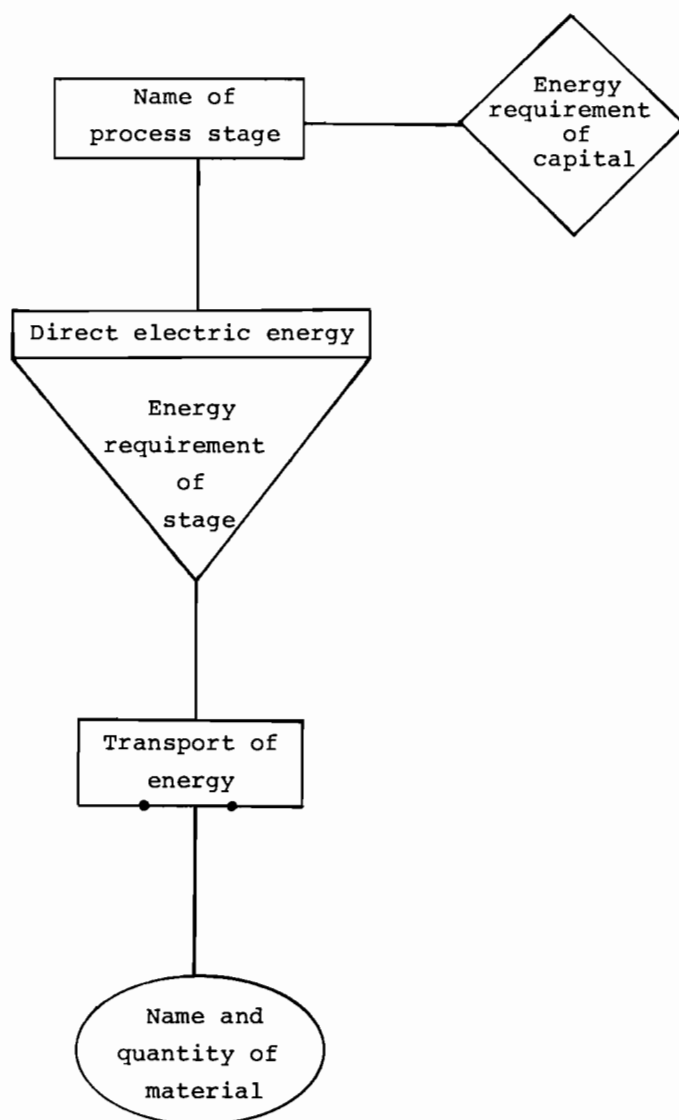

Figure 10.

For classic walls now frequently used in the building industry (without isolation, $K = 1.5$), the average amount of energy needed for building is 6.4 kWh_e and $81.0 \times 10^3 \text{ kcal per m}^2$. A flow diagram like Figure 11 has the advantage of giving a clear idea of the energy consumed at each step of the process, and it allows us to make valuable process comparisons.

Next, Table 9 summarizes an order of magnitude for supplying different products, all estimated in kw_{th} (or kwy) and in primary energy.

2.3 Statistical Approach

A statistical approach to energy consumption is simpler in principle than an engineering approach because it deals only with a given economic sector. In fact, the information obtained has to be carefully examined in order to know precisely the boundaries of the studied system.

At IIASA we currently gather data on the four major sectors:

- household. At the time being only the direct energy used for different appliances is at our disposal.
- transport. The direct energy used in different means of transport has also been in the first step. Investigations of indirect energy (i.e. energy needed for building the means of transport themselves) are just beginning. In fact, indirect energy investigation is not made through statistical investigations, which are practically nonexistent, but through engineering investigations.
- industry. Only investigations relating to the elaboration of the basic materials are under development: steel, iron, concrete, copper, aluminium, glass, etc.
- agriculture. Various cross-section analyses between different countries and protein production are made in

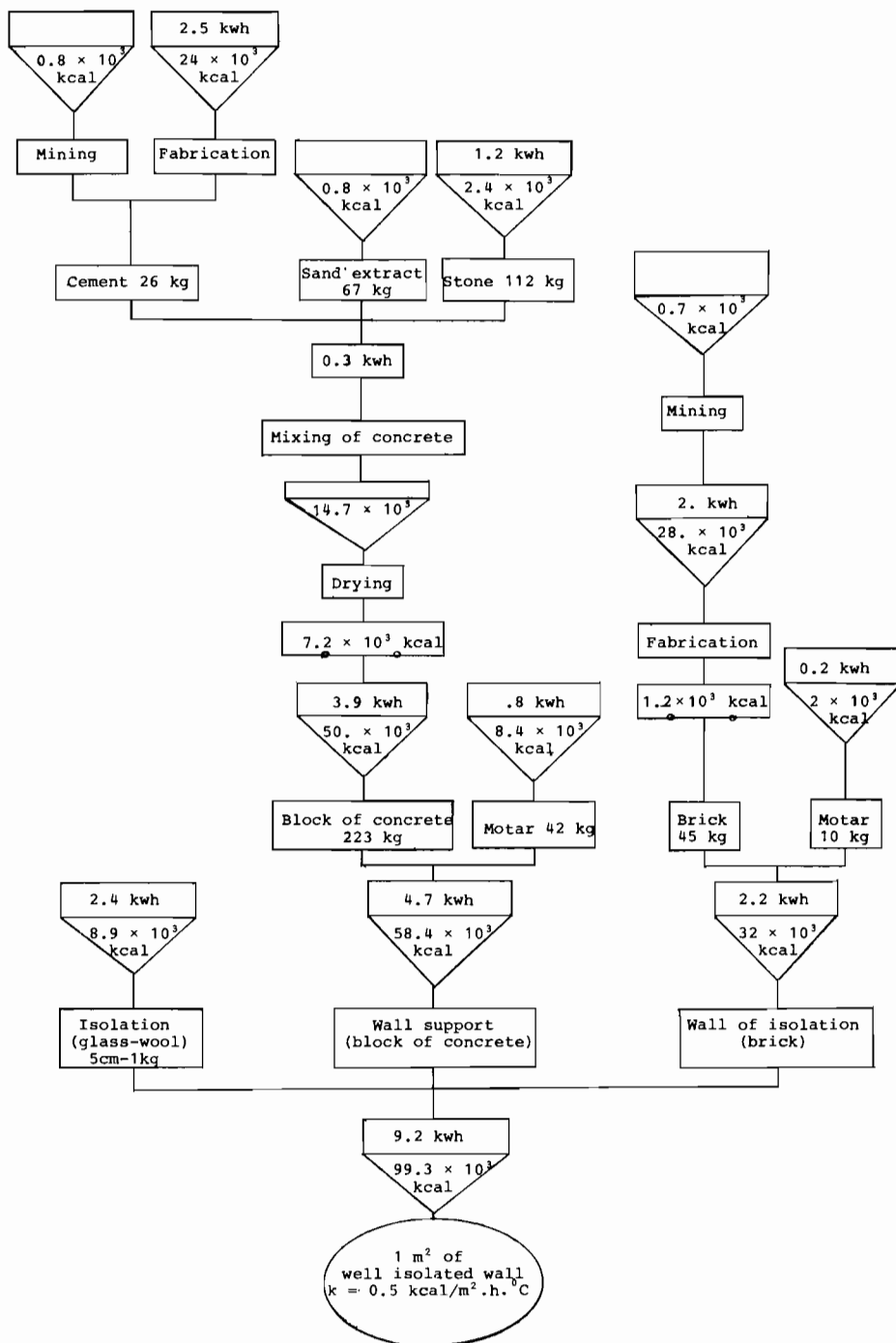

Figure 11. Flow diagram for building a wall.

Table 9.

| | kw _{th} /t |
|---|---------------------|
| Aluminium (fused electrolysis, from bauxite) | 4.70 |
| Aluminium (fused electrolysis, recycling) | 0.30 |
| Iron (electric furnace, from iron ore) | 0.30 |
| Nickel (electrolytic, from nickel ore) | 0.60 |
| Zinc (electrolytic, from zinc ore) | 0.90 |
| Perchlorates (electrolytic, from salt brines) | 1.00 |
| Zirconium (reduction by magnesium from zirconium ore) | 10.20 |
| Steel (high furnace, iron ore + limestone + coke) | 0.90 |
| Copper (1% sulfite ore) | 1.50 |
| Copper (recycled - 98% Cu scrap) | 0.07 |
| Cement | 0.16 |
| Plaster | 0.08 |
| Paper | 0.92 |

Note: In considering different final products Dr. Stephen Berry found 3.48 kw_{th} of energy is required to build an American car, and A. MacKillop estimated the energy required to build a private house of 100 m² at 5.31 kw_{th}.

order to link energy used in the agricultural sector with protein production. The approach is the same as Slessor [20].

2.4 Use of I/O matrices

2.4.a Methodology¹

The I/O matrices are based on the linear relation:

$$X_i = \sum_{j=1}^n A_{ij} X_j + Y_i$$

where

X_i = the total output (dollars) of sector i ;
 Y_i = the output (dollars) of i sold to final demand;
 A_{ij} = constants, obtained empirically from the data;
 X_j = sales ($i \rightarrow j$)/total sales j for the study year;

or in matrix form,

$$X = AX + Y \quad \text{or} \quad X = (1 - A)^{-1} Y .$$

To convert to energy terms, let

$$E_i = \sum_{k=1}^n E_{ik} + E_{iy} ,$$

where

E_i = total energy output (BTU) or energy sector i ;
 E_{ik} = energy sales (BTU) from i to k ;
 E_{iy} = energy (BTU) of type i sold to final demand.

Since

$$E_{ik} = \left(\frac{E_{ik}}{X_k} \right) X_k = \frac{E_{ik}}{X_k} \sum_{l=1}^n \left[(1 - A)^{-1} \right]_{kl} Y_l ,$$

¹For more details see Herendeen [13].

$$E_i = \sum_{k=1}^n \sum_{l=1}^n \frac{E_{ik}}{X_k} \left[(1 - A)^{-1} \right]_{kl} Y_l + \left(\frac{E_{iy}}{Y_i} \right) Y_i ,$$

we define

$$R_{ik} = E_{ik}/X_k$$

$$S_{ik} = \begin{cases} E_{iy}/Y_i, & i = k = \text{energy sector,} \\ 0, & \text{otherwise} \end{cases} .$$

Then

$$E = \left[R(1 - A)^{-1} + S \right] Y = \epsilon Y ,$$

where

ϵ = total energy matrix;

ϵ_{ij} = total output (BTU) of energy sector i required for the economy to deliver a dollar's worth of project j to final demand, \$1 FD (j).

2.4.b Application to France (1971)

This method has been applied with French data in order to investigate the energy content in a nuclear reactor (LWR). Figure 12 gives an example of the decomposition of energy need per dollar for the building sector (the basic information is the I/O matrix and the energy balance table related to the same sector used in the I/O matrix).

3. Example of Application

3.1 Energy Needed for Building Nuclear Power Plants

Because the data are available to work with, this calculation is based on French data for the year 1971. Nevertheless, it is obvious that the final answer would not change very much with 1975 data.

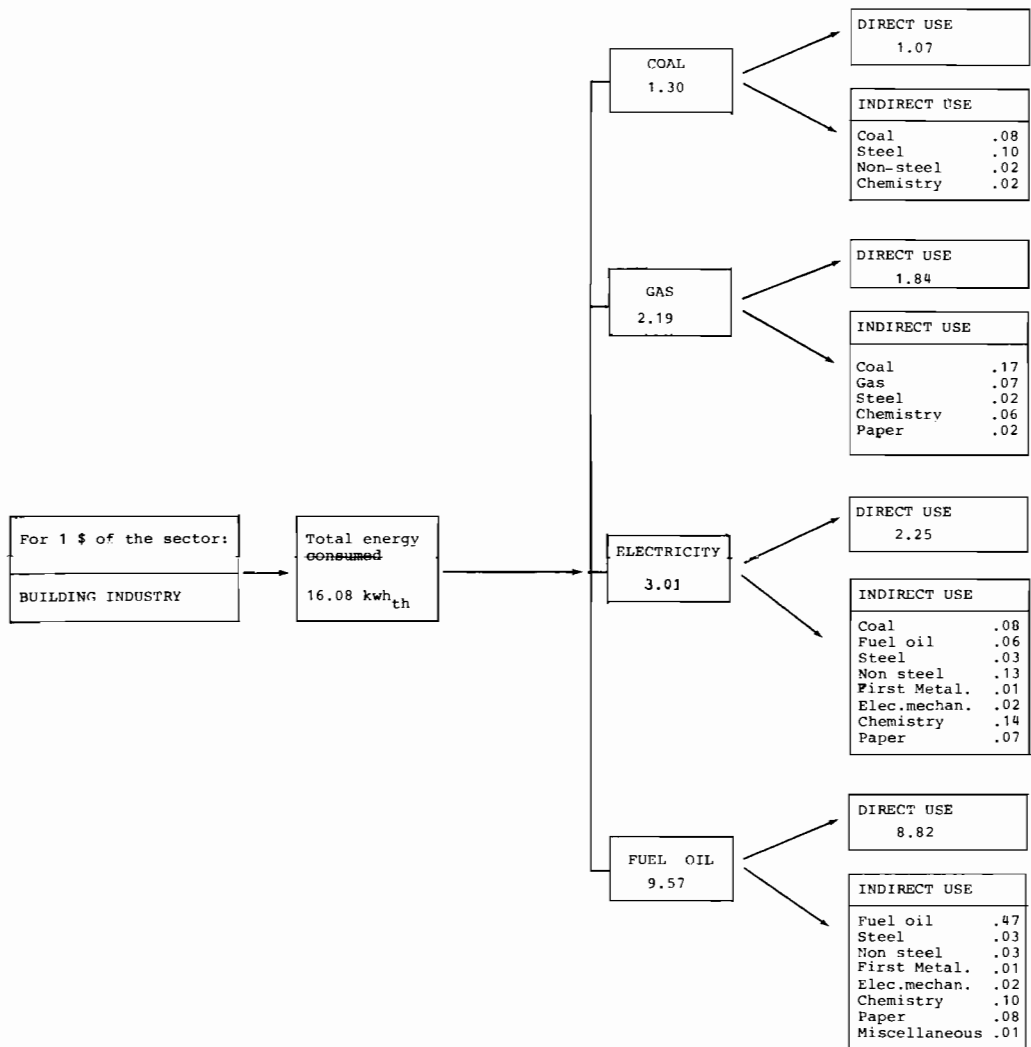

Figure 12. Energy consumption per unit value of output for France 1971.

3.1.a Energy Required for Delivering a Dollar's Worth of Product from Different Industrial Sectors Related to the Building of a Nuclear Reactor

In using the I/O matrix and the method proposed, the following information in Table 10 is obtained for France in 1971.

Table 10.

| Industrial Sector | Energy Required |
|------------------------------------|---|
| Building industry | 16.1 kwh _{th} per \$ of output |
| First metal process | 11.4 kwh _{th} per \$ of output |
| Chemistry | 11.4 kwh _{th} per \$ of output |
| Electrical and mechanical industry | 6.0 kwh _{th} per \$ of output |

Note: this energy requirement takes into account the chain of processes used to obtain the market product.

3.1.b Energy Needed for Building and Feeding a One kw_e (LWR) Nuclear Plant

To build a plant without its fuel, the direct investment cost of a nuclear plant in 1971 was 1,200 F/kw_e or \$267/kw_e if we agree with the following decomposition of the cost:

| | | |
|--|---|-----------------|
| - reactor vessel | } | 47.9% |
| - steam generator | | |
| - alternator + miscellaneous electric appliances | | 29.7% |
| - building on specific area | | 22.4% |
| | | <u>100.0%</u> . |

Then, in using the energy allocation obtained from the I/O matrix, we obtain the following for each item (see Table 11).

Table 11.

| | Sector | Energy kwh_{th} |
|---|--|---------------------------------|
| Reactor vessel Steam generator | Metal process | 1,315.1 |
| Alternator + miscellaneous electric appliances | Electric and mechanical industries | 428.4 |
| Building | Building | 863.9 |
| | TOTAL | 2,607.4 |

Note: In Kolb et al. [15] the total energy required was found to be between $2,538 \text{ kwh}_{\text{th}}$ and $2,738 \text{ kwh}_{\text{th}}$.

3.1.c Production of Nuclear Fuel

In the fuel cycle we will only take into account the direct energy needed for elaborating the nuclear fuel and not the energy needed for building the plants of the fuel cycle. The fuel cycle will be divided into the following process:

- a) mining (open and underground mining);
- b) concentration;
- c) fabrication of UF_6 nat;
- d) enrichment by diffusion plant;
- e) fabrication; and
- f) reprocessing.

The first load of an LWR needs approximately 0.1 kg of enriched uranium at 3% per kw_e . This amount is obtained with 0.7 kg of natural uranium and 0.35 kg of separative work units (swu) (if the tail rate is 0.3%).

To obtain this fuel, let us consider the energy required for a) to f).

a.1) Mining: Open Mine. Let us take an average ore at 2% from which 0.7 kg of nat uranium corresponds to 350 kg of ore.

The average volume of earth to be handled is ten times the amount of the extracted ore, or 3,500 kg. Statistically speaking, the energy needed (trucks, compressors) for this mining is 700 kg of fuel oil for each 10^3 t of earth handled (see Caralp [4]). The energy needed for the 3,500 kg is 2.45 kg of fuel oil (at 10^4 th/t) or $2.45 \times 10 \times 1.16 = \underline{28.42}$ kwh_{th} (for supplying the first load of one kw_e LWR).

a.2) Mining: Underground Mine. To determine the amount of energy required here, let us take an average ore at 3% from which 0.7 kg of nat uranium corresponds to 233 kg of ore. In mining, almost all energy required is in the form of electricity. Statistically speaking, the energy needed is 90 kwh/t of ore (see Caralp [4]). In this case, the energy needed at the mining level for supplying the first load of one kw_e LWR is then twenty-one kwh_e or \approx fifty-four kwh_{th} . Even with ten times more material to handle, the energy consumption in an open mine is half that of an underground mine.

b) Concentration. Let us consider the energy required to concentrate the ore. According to statistics (see Caralp [4]) the energy needed is thirty-nine kwh/t of ore and twelve kg fuel oil/t of ore used directly in plant, and 0.88 t fuel oil/t of metal and 0.12 t propane/t of metal for drying.

b.1) Concentration of ore: Open Mine. The energy required to concentrate this ore (at 2% for 0.7 kg of U from 350 kg of ore) is:

| | | | |
|-------------|----------------------|-------|--|
| direct use: | 13.65 kwh_e | or | 34.83 kwh_{th} |
| | 4.2 kg fuel oil | | 48.72 |
| drying: | 0.62 kg fuel oil | | 7.15 |
| | 0.08 kg propane | | 0.97 |
| | | Total | <u>91.67 kwh_{th}</u> . |

b.2) Concentration of ore: Underground Mine. The energy required to concentrate this ore (at 3% for 0.7 kg of U from 233 kg of ore) is:

| | | | |
|-------------|---------------------|-------|---------------------------|
| direct use: | 9.09 kwh_e | or | 23.19 kwh_{th} |
| | 2.80 kg fuel oil | | 32.43 |
| drying: | 0.62 kg fuel oil | | 7.15 |
| | 0.08 kg propane | | 0.97 |
| | | Total | 63.74 kwh_{th} . |

Table 12 gives a summary of the energy needs for supplying 0.7 kg of nat uranium.

Table 12.

| In kwh_{th} | Open Mine (2%) | Underground Mine (3%) |
|------------------------|-------------------|--------------------------|
| Mine | 28.4 | 54.0 |
| Concentration Plant | 91.7 | 63.7 |
| Total | 120.1 | 117.7 |

c) Fabrication. For the fabrication of UF_6 nat the average energy consumption (Caralp [4]) is eight kwh per kg of nat uranium. For 0.7 kg, the energy is 5.6 kwh_e or 14.3 kwh_{th} .

d) Enrichment. For a diffusion plant the energy needed is roughly 2,400 kwh_e per kg swu (Caralp [4]). In our case study, we will need 0.35 swu, which corresponds to 840 $\text{kwh}_{th}/\text{kg}$ of U. kwh_{th} .

e) Fabrication. For fabrication the energy required, as found in a report by Kolb et al. [15] is 312 $\text{kwh}_{th}/\text{kg}$ of U. For 0.1 kg of U one needs 31.2 kwh_{th} .

f) Reprocessing. For reprocessing we use the energy requirement found in the Kolb report: 580 $\text{kwh}_{th}/\text{kg}$ of U which corresponds

to fifty-eight kwh_{th} for 0.1 kg. Note that if one uses the I/O technique for the last two items, fabrication and reprocessing, and considers them as part of the classical chemical industry, together they require $148 \text{ kwh}_{\text{th}}$.

To summarize, then, the energy needed for the elaboration of a first load for a one kw_e LWR is:

| | | |
|------------------------------------|--------------------------------|---|
| - mining + concentration | 119 kwh_{th} | (average between open and underground mine) |
| - fabrication of UF_6 nat | 14 | |
| - enrichment (diffusion plant) | 2,144 | |
| - fabrication | 31 | |
| - reprocessing | 58 | |
| | Total | |
| | 2,366 kwh_{th} | . |

The results are that the energy needed for building an LWR of one kw_e is $2,607 \text{ kwh}_{\text{th}}$ and the energy needed for supplying the first load is $2,366$. Together they total $4,973 \text{ kw}_{\text{th}}$ or $0.57 \text{ kw}_{\text{th}}$. Figures 13 and 14 summarize the energy flow.

Note finally that concerning the amount of raw material needed for building such a plant, the order of magnitude is:

$$\text{per kwe} \left\{ \begin{array}{l} 14 \times 10^{-3} \text{ m}^3 \text{ of concrete} \\ 14.5 \text{ kg} \quad \text{of steel.} \end{array} \right.$$

3.2 Energy Ratio Between Energy Input for Building A Reactor and Net Energy Output Supplied by this Reactor (One kw_e)

3.2.a Energy Input

Let us recall the result obtained (see Table 13) for energy input.

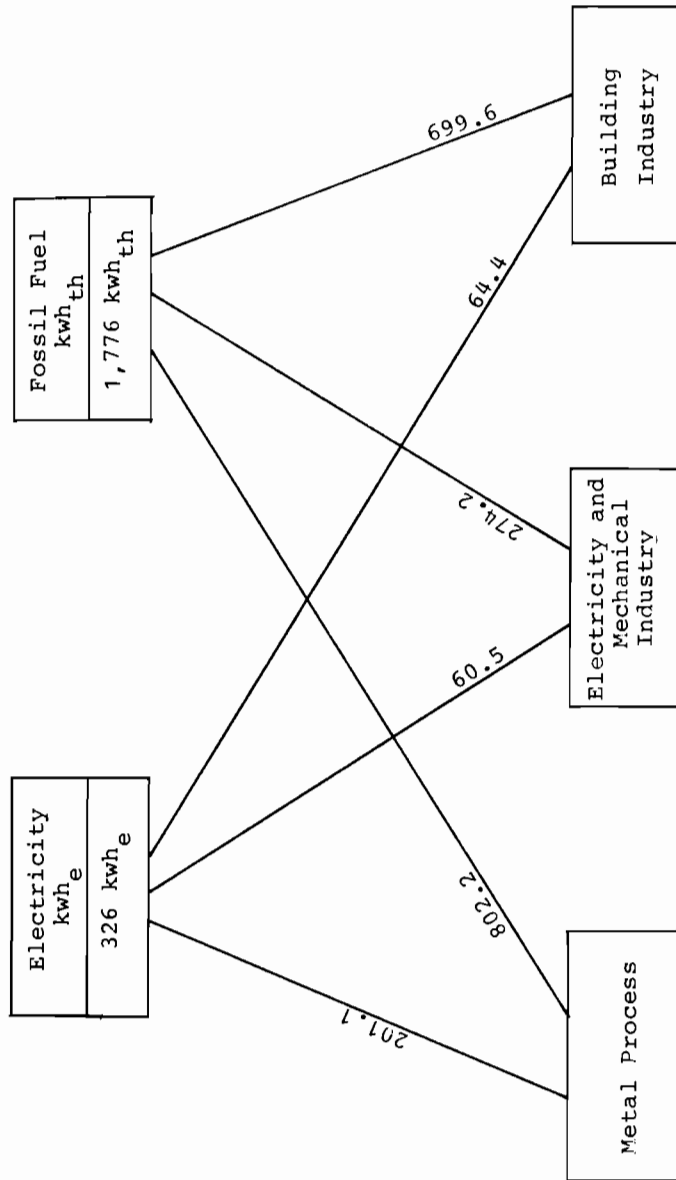
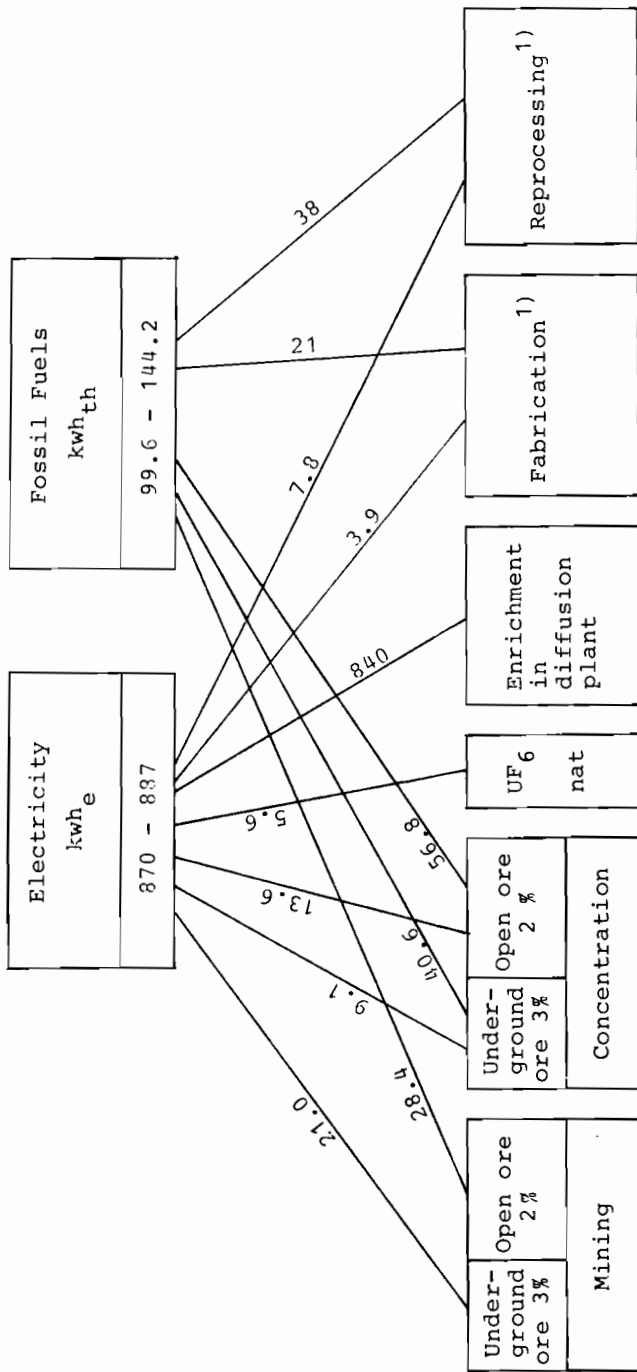

Figure 13. Energy flow for building an LWR of one kW_e (without fuel).



¹⁾ Currently we know only the total amount of energy, and we arbitrarily divided it into 1/3 electricity, 2/3 fossil fuels.

Figure 14. Energy flow needed for building the first load of one kw_e LWR.

Table 13.

| | Electricity kwh_e | Fossil Fuel kwh_{th} |
|--------------------|--|----------------------------------|
| Reactor | 326 | 1,776 |
| First load | 880 | 120 |
| Total energy input | 1,206 kwh_e and 1,896 kwh_{th} | |

3.2.b Net Energy Output

The net energy output is the difference between the electricity supplied by the plant less the energy needed for supplying the annual load. Let us assume that the load factor of the nuclear plant is 6,000 working hours per year, and that the lifetime is thirty years. The total energy output during the lifetime is 180,000 kwh_e . The energy needed for the annual load (1/3 of the first load) is $\frac{880}{3} \times 30 = 8,800 \text{ kwh}_e$ for electricity, and $\frac{120}{3} \times 30 = 1,200 \text{ kwh}_{th}$ for fossil fuel.

3.2.c Recovery Time Period

Let us summarize the I/O energy flow of an LWR (one kwe) during its lifetime (see Figure 15). (This figure corresponds to the building of the first nuclear reactor. For an all nuclear society the system described would be different.)

It is assumed that:

- all electricity needed for building the reactor and the first load is supplied by a fossil-fuel plant; and
- that the electricity needed for supplying the annual load of the LWR is produced by the reactor itself (see Figure 16).

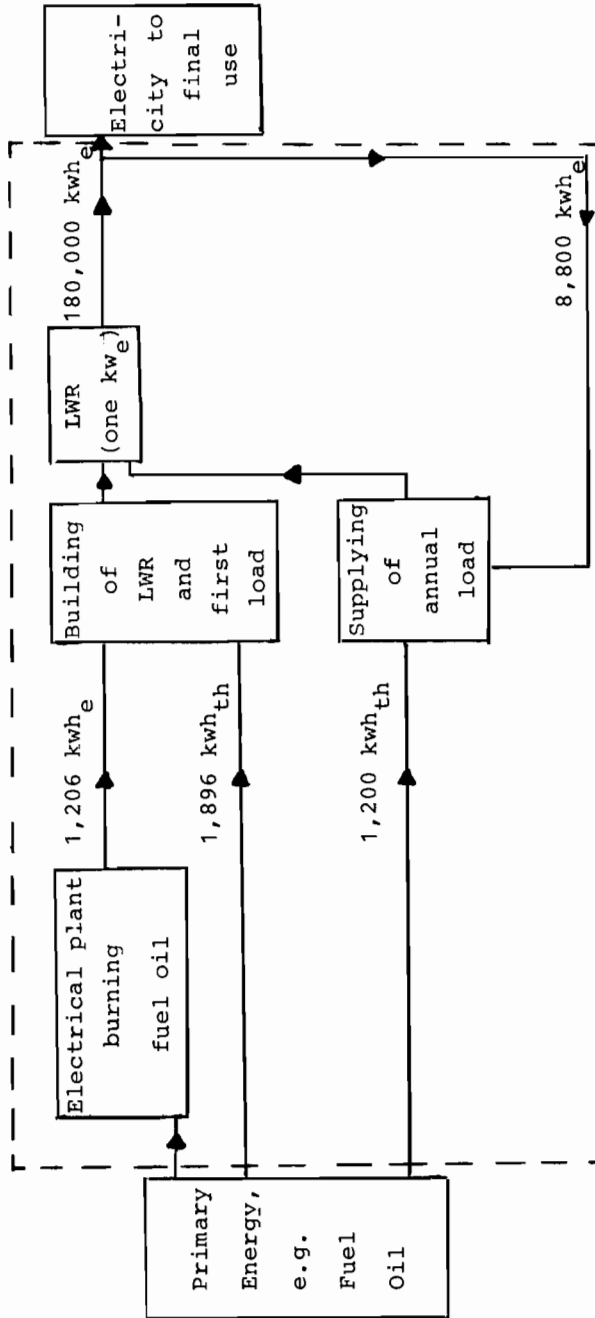

Figure 15. LWR I/O energy flow.

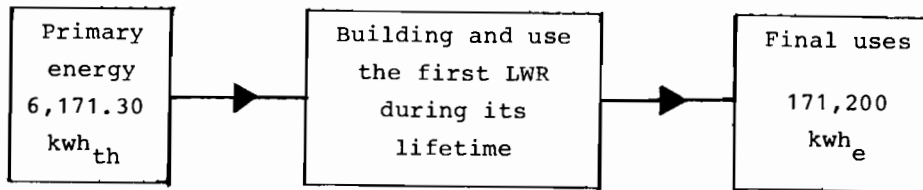

Figure 16.

Like Chapman (see [5-9]), we can define the net energy ratio as:

$$\frac{\text{Total energy output in } \text{kwh}_e}{\text{Energy input in } \text{kwh}_{th}} \approx 28 .$$

Next, the recovery time corresponds to the period after which the reactor "reimburses" its energy input. A reactor of one kwe supplies $\frac{171,200}{30} = 5,706.7 \text{ kwh}_e$ net energy per year. If the entire amount of primary energy, currently fossil fuel ($6,171.30 \text{ kwh}_{th}$), used for building this reactor had been burned in a classical electrical plant, the electrical energy supplied would have been $2,420 \text{ kwh}_e$. The recovery time in this case is five months.

3.2.d Impact on Building a Nuclear Program

Let us assume that the time for building a reactor is five years, and that its lifetime is thirty years. Figure 17 shows the global net energy output in the system for three different nuclear programs:

- one nuclear plant per year,
- six nuclear plants per year, and a
- progressive program of one additional reactor per year.

Whatever the nuclear program is, the net energy output is negative during the first six years. Let us recall that by hypothesis reactors begin to supply electricity only at the

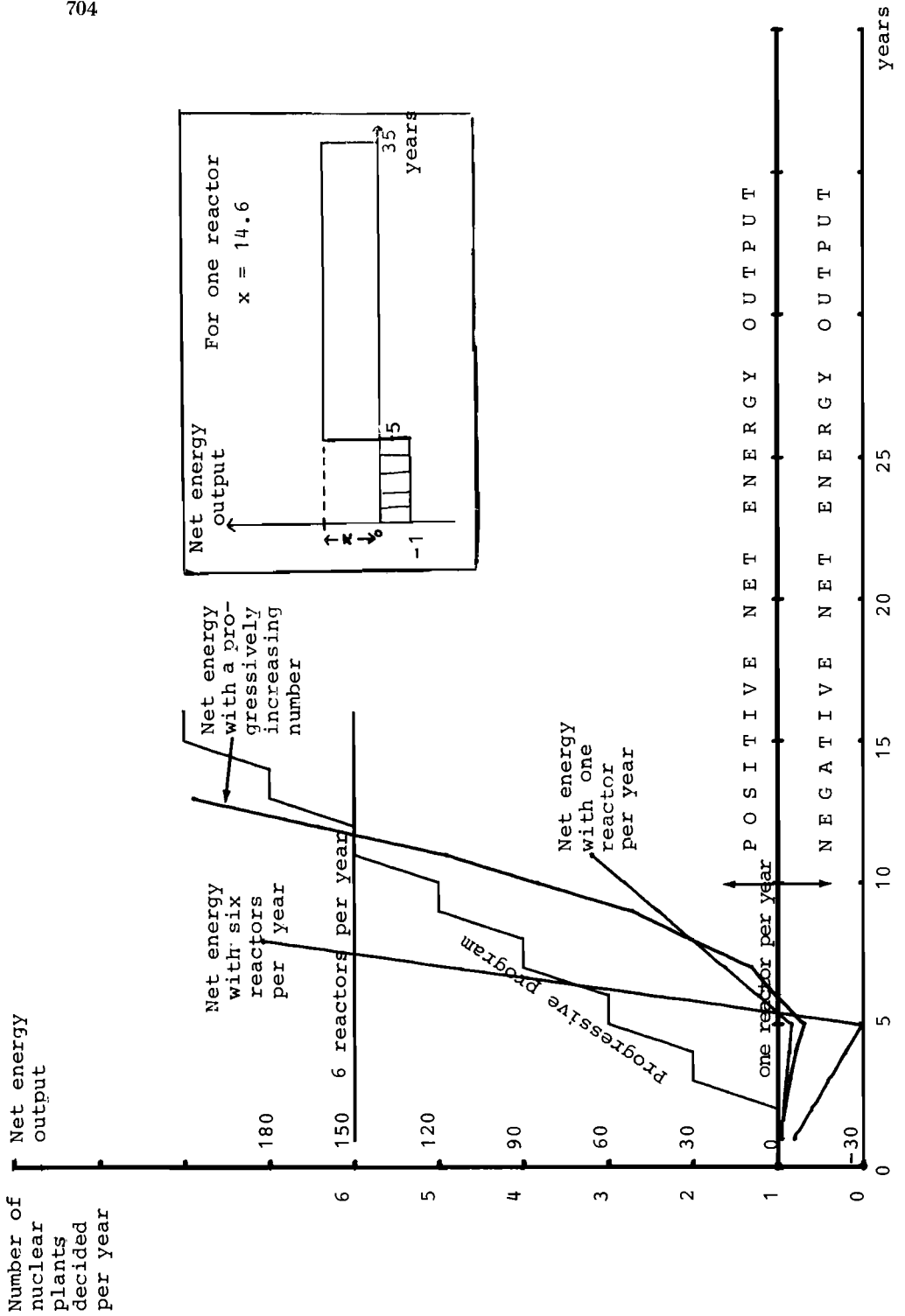

Figure 17. Evolution of net energy output related to nuclear program investment. (The first five years correspond to the building of the reactor.)

end of the fifth year, (The building period is five years.)
However, only one year could be considered as a negative production period in the worst case.

3.3 Comparison Between a Nuclear Plant and a Fossil Fuel Plant

Calculations similar to those above show that the construction of a fuel-oil plant needs only 16% less energy than the construction of a nuclear plant.

Conclusion

This report summarizes the basic information that has been gathered at IIASA for building scenarios. Two types of scenarios are being studied:

- differential scenarios for developed countries. They essentially deal with the question: "if sector x changes in such way, then..."; and
- global scenarios essentially for developing countries. The goal as Professor Stephen Berry and Dr. Malcolm Slesser state it is to build an economy with a minimum of thermodynamics.

References

- [1] Benzecri, J.P. "L'Analyse des Données." Dunod, 1973.
- [2] Berry, S.R., Long, T.V., II, and Makino, H. Energy Budgets. Chicago, University of Chicago, 1974.
- [3] Berry, S.R., Long, T.V., II, and Slessor, M. "Guidelines for Energy Analysis." IFIAS Workshop. Stockholm, 1974.
- [4] Caralp, J.C. Personal communication on "Consommation Énergétiques de 1973 à la Direction des Productions." France, CEA, April 1975.
- [5] Chapman, D., and Tyrrell, T. "Alternative Assumptions about Life-Style." Report No. 2. Ithaca, New York, Cornell University, 1972.
- [6] Chapman, P.F. "Energy cost: A Review of Methods." Energy Policy (June 1974).
- [7] Chapman, P.F. "The Energy Costs of Materials." Energy Policy (March 1975).
- [8] Chapman, P.F., Leach, G. and Slessor, M. "The Energy Cost of Fuels." Energy Policy (September 1974).
- [9] Chapman, P.F., and Mortiner, W.D. "Energy Inputs and Outputs for Nuclear Power Statistics." Energy Policy (1974).
- [10] Charpentier, J.-P. "Overview on Techniques and Models Used in the Energy Field." IIASA RM-75-8. Laxenburg, Austria, International Institute for Applied Systems Analysis, 1975.
- [11] Commissariat Français au Plan. "Besoins en Energie du Secteur Tertiaire: 1973." Rapport du Groupe de Travail.
- [12] Commissariat Français au Plan. "Besoins en Energie du Secteur Transport: 1973." Rapport du Groupe de Travail.
- [13] Herendeen, R.A. "Use of I/O Analysis to Determine the Energy Cost of Goods." In M.S. Macrakis, Ed. Energy: Demand, Conservation and Institutional Problems. Cambridge, Massachusetts, MIT Press, 1974.

- [14] Howell, J.A., and Slessor, M. "An Alternative Approach to Relative Indices of Development and Potential for Change in the Nation States." Technological Forecast, 5 (1973), 253.
- [15] Kolb, Niehaus, Rath-Nagel, Turowski, and Voss. "Nettoenergiebilanz der Kernenergie." Juelich, KFA, March 1975.
- [16] Mooz, W.E. "Energy and Transport." Rand-R-804 NSF. March 1973.
- [17] Organization for Economic Cooperation and Development. Statistics of Energy 1958-1972.
- [18] Science. Special issue on energy. April 19, 1974.
- [19] Slessor, M. "Energy Analysis in Technology Assessment." United Kingdom, University of Strathclyde, 1973.
- [20] Slessor, M. "Energy Subsidy as a Criterion in Food Policy Planning." Energy Policy (June 1973).
- [21] United Nations Commission Economique pour l'Europe. "Etudes des Tendances dans les Pays de la Région de la CEE." Rapport E.C. AD(XII) R.3. Geneva, December 1974.
- [22] United Nations Commission Economique pour l'Europe. "Evolution des Coefficients Techniques dans les Tableaux d'Echanges Interindustriels." Rapport E.C. AD(XII) R.3. Geneva, January 1975.
- [23] United Nations. Statistical Yearbook of the U.N. 1972.
- [24] Wright, D.J. "Goods and Services." Energy Policy, 2 (December 1974), 25.



V. LINKAGES TO THE REST OF THE ECONOMY



An Energy Forecasting Model for Sweden

Lars Bergman, Anders Björklund, and Karl-Göran Mäler

1. Introduction

Energy demand predictions for Sweden have so far been made by means of rather simple methods. Essentially the forecasts have been "informed" trend extrapolations for a number of sectors. That is, when more information has become available, the trends have been adjusted in the light of the additional information.

This methodology does not, of course, systematically incorporate the influence of prices. Further, it does not guarantee that these forecasts are internally consistent, that is, that the demand for each group of commodities is equal to the supply of these commodities. Although these drawbacks are important from a theoretical point of view, energy demand forecasting in Sweden has been fairly successful, at least in terms of prediction-outcome comparisons. This result shows that the chosen methodology works well in a situation of stable energy prices and economic growth.

However, the Swedish energy demand forecasters are now facing a new situation, a situation in which the theoretical weaknesses of the old methodology become important. There is a sharply increased uncertainty about the future course of a number of important factors behind the determination of the demand for primary energy in Sweden.

In the first place there is great uncertainty about future prices of oil. Since there is evidence (see Bergman [3] and Bergman and Bergström [4]) that oil-price changes, at least if they are of the magnitude experienced in late 1973, definitely affect the economy's system of relative prices, the future sectoral allocation of resources in Sweden to some extent will depend upon the price of oil. Further, the sectoral allocation

of resources in the Swedish economy has a considerable impact upon the overall energy-intensiveness of GNP (see Bergman and Bergström [4]). Thus, the energy demand forecast is not independent of the assumption about the future price of oil. Since this price is very unpredictable, the energy demand forecast for Sweden should not be based upon one single price prediction. The conclusion must be that prices should explicitly be taken account of in the forecasting work.

Not only the price of oil but also the future course of Swedish economic and energy policy will affect the size and composition of the future use of energy in the country. The impact can be in terms of limits on investment activity in the energy transformation sector and also in terms of the choice of technology in this sector. Further, long run policy goals concerning the size of the public sector and the current account position will influence resource allocation in the economy. Finally, the structure of taxation will influence prices and thus resource allocation. However, today the future course of Swedish energy policy is highly uncertain. The recent proposal by the government may very well be revised when more is learned about nuclear power and the effects of the proposed policy measures. Obviously, the energy demand forecasts should not be based upon one single formulation of long run economic policy. Rather, the energy demand forecasts should to some extent serve as a tool for evaluation of long run policy strategies.

Thus, if the situation in the international markets for primary energy commodities and the domestic strategy for implementation of policy goals are seen as exogenous forces in relation to the Swedish economy, then the energy demand forecasts should explicitly be conditioned by assumptions about these exogenous forces. Thus, different conditional "futures" of "scenarios" for the use of energy in Sweden can be generated. The "scenario" that is deemed most likely can be chosen as the forecast. However, if this exercise is to be meaningful the different "scenarios" ought to be internally consistent. In order to secure consistency a model of the whole economy is needed.

With this background we can state: The purpose of this project is to develop a consistent multi-period and multi-sectoral model of the Swedish economy. In the model the final demand functions should incorporate prices as arguments. Further, the model should be formulated in such a way that the exogenous conditions of the solutions could easily be changed. In the following a brief description of the result of our ambitions is given.

2. A General Description of the Model

In order to fulfill our ambitions we have chosen a somewhat mixed approach. The model is based upon an input-output table. The input-output vectors for the energy transformation sectors (electricity generation, refineries) have been replaced by optimization models utilizing engineering data. Further, a sector for "house heating production" is constructed. The production system of this sector is described by means of an optimization model, again utilizing engineering data. The model description of the supply system in addition includes import and export processes as well as a matrix of capital coefficients.¹

On the demand side an econometric model of the private demand for consumption goods is utilized together with exogenously determined forecasts about the public demand for resources. An econometric submodel of the demand for private travelling is linked to the system of private consumption demand equations.

The model is intended to be a medium-term model. By this is meant that the time period is sufficiently long to allow substitutions and adjustments to take place, but still so short that no fundamental technological change will have time enough to occur.

¹If b_{ij} is a coefficient in this matrix it is interpreted as the amount of commodity i needed to expend the productive capacity of sector j by one unit.

The general structure of the model can be seen in Figure 1 below. In the following sections a very brief description of the various parts of the model is given. A more complete description of the model will become available in July 1975.

2.a Electricity and Hot Water Production

This model draws heavily upon the modelling tradition that originates in the work done at Electricite de France (EDF) in the late forties (see Anderson [1]; the model is also similar to one developed by Bergendahl [2]). In this tradition there are many examples of very refined models. This model, however, is a simple linear programming model. It differs from the mainstream of the EDF-tradition in that it takes account of the joint production of electricity and hot water.² The continuous load-duration curve is approximated by a step-function with seven intervals. The model distinguishes ten different kinds of plant, namely:

- 1) nuclear plants;
- 2) combined nuclear plants (electricity and hot water);
- 3) oil-fired, base-load plants;
- 4) coal-fired, base-load plants;
- 5) oil-fired, peak-load plants;
- 6) combined oil-fired plants, old type;
- 7) combined oil-fired plants, new type;
- 8) gas turbines;
- 9) hot water generating plants; and
- 10) hydro power plants.

Given an exogenously determined forecast of the demand for electricity and hot water during a number of five-year periods, the model determines the cost minimizing set of investment and operations activities. The dual formulation of the model

² Long-distance transportation of hot water for house heating purposes is becoming increasingly important in the Swedish house heating system.

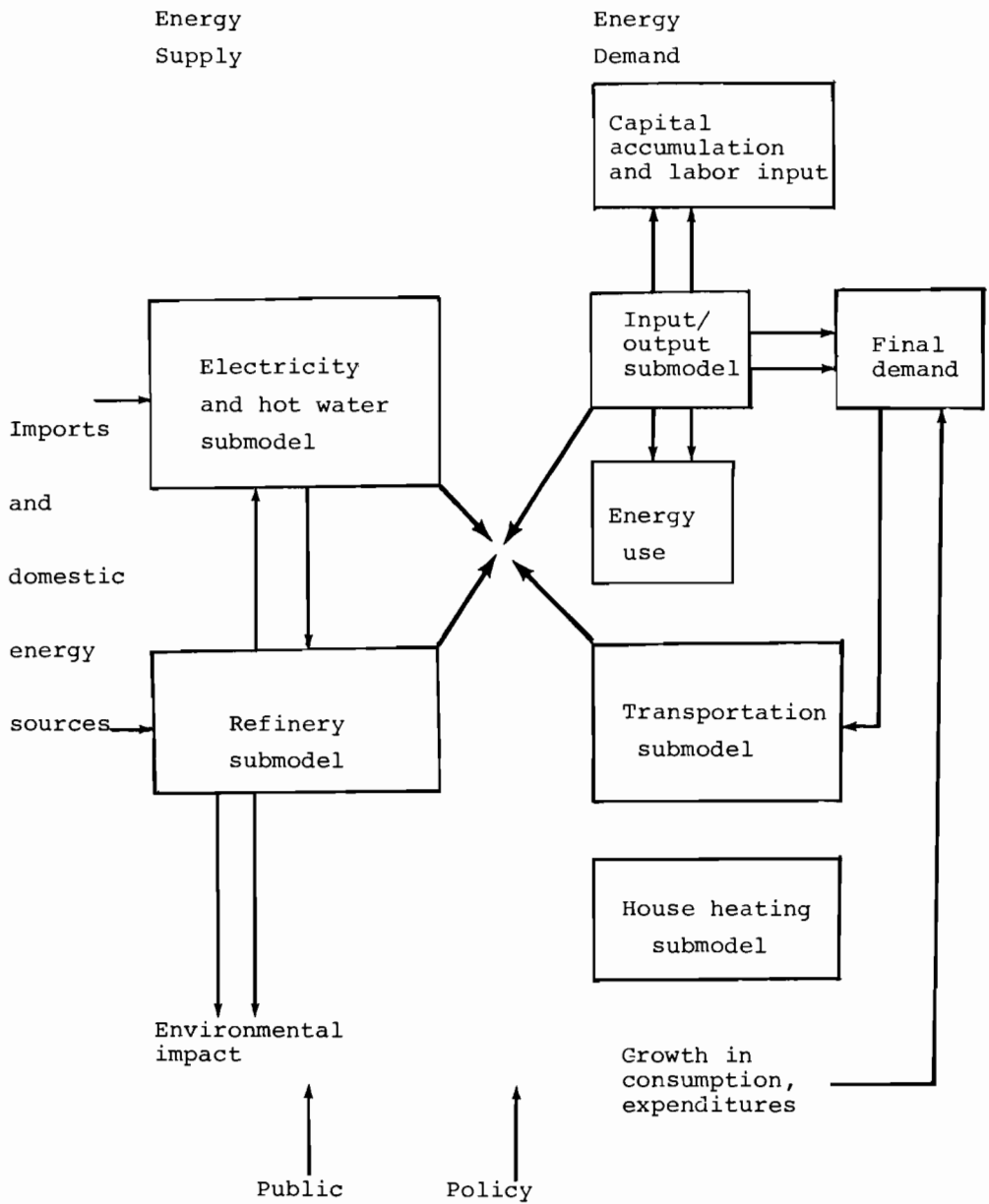

Figure 1. Model structure.

determines the long-run marginal costs of electricity and hot water production during the peak and off-peak hours of the different time periods.

2.b Refineries

This model has essentially the same structure as the above described model, although the problems connected with load variations do not appear in this case. The refinery model is constructed in such a way that it is possible to take account of the specific properties of different kinds of crudes. Thus, the model can indicate some of the consequences of a shift in the composition of crude oil imports.

2.c House Heating Production

In this model, again of the linear programming type, a number of "house heating processes" are defined. The cost of utilizing a specific kind of heating process in a specific kind of house (in terms of age, location, insulation, etc.) in order to keep a specific indoor climate is calculated. In addition the cost of shifting from one heating system to another is calculated for a number of house types and heating systems.

Given the number of houses of the different kinds in a number of periods and an exogenously determined indoor climate for these houses, the model determines the cost-minimizing set of heating systems in the stock of houses. Further, the model determines the marginal cost of a better indoor climate.

2.d The Supply of Non-Energy Commodities

This model consists of the remaining parts of the input-output table and a number of import and export processes.

The model is entirely linear. As is well-known, linear models tend to give corner solutions, which in this case means that a commodity may be domestically produced or imported but never both. In reality, however, a sector consists of a number of plants differing in age and productivity. If the world market price of the sector's output commodity falls, a few plants may not be able to cover their operation costs, while others can. Thus, the size of the sector is endogenously determined by world market prices, but not in such a dramatic way as in a linear model based upon input-output data.

In order to circumvent this problem the activity levels of the domestic production sectors are constrained downwards in the first version of the model. Later on, a more realistic description of the plant structure in the different production sectors will be incorporated in the model.

2.e The System of Private Consumption Demand Equations

The system of private consumption demand equations can be said to serve two interrelated purposes. First, the system allocates private consumption among the sectors of production in the input-output model. Second, at the same time the system constitutes a mechanism of adjustment, since changing relative prices induced by for example rising energy prices will reallocate private consumption in an energy-conserving way.

The emphasis on the latter purpose has led us to reject the so-called additive models--linear expenditure and indirect addilog systems--since these models restrict the substitution among goods too much. In some recent papers the ability of these models to estimate independent income- and price-effects has been questioned. Therefore we have chosen the so-called Rotterdam Model although this model can be said to be inconsistent with the utility theory of the consumer. This drawback is considered small in comparison with the empirical

advantages which the model has. Private consumption will be divided into ten subgroups. The model will be estimated with the so-called Zellner method for seemingly unrelated equations. The restrictions on the parameters of the equations which follow from the theory of the consumer will be tested.

3. The Solution of the Model

In order to solve the whole model, the various models described above have to be integrated into one big model. Since all the supply models are linear they can be integrated easily. The private consumption demand model, on the other hand, is non-linear which leads to some problems. The solution of the whole model is found after an iterative process involving the following steps.

3.a The Determination of An Initial Price System

Many of the production sectors covered by the Swedish input-output statistics are exposed to foreign competition. Since Sweden is a small country this generally means that the output prices of these sectors can be looked upon as exogenously determined. Thus, an assumption on the exogenously given world market prices is needed. The first step in the solution of the model is therefore to extrapolate past price trends for a number of internationally traded commodities. Then these trends are adjusted for known and expected changes in the price of oil. Given these adjusted trends and a set of productivity predictions the initial price system is determined by means of an input-output model. The price system is also influenced by the specific assumptions made about the Swedish energy policy. Observe that changes in the price of oil are supposed to change the cost of production in all countries, while domestic policy measures only affect the cost of production in domestic production sectors.

3.b The Determination of a Preferred Composition of Total Private Consumption

Given the initial price system and an assumption about the growth in total real private consumptions³ the preferred commodity composition of private consumption is determined by means of the econometric demand model. The public demand for commodities is exogenously determined.

3.c The Determination of An Efficient Growth Path for the Economy

Neglecting final demand for the moment, the rest of the model is one linear system, composed of the input-output system, import-export processes (determined by the assumption on the development of the world market prices), electricity and hot water production, oil refinery processes and house heating production. The system can be regarded as one linear programming model with the objective of maximizing the present value of real private consumption. The dual to this model will generate shadow prices which can be interpreted as domestic prices. If these shadow prices generate a private consumption vector by the system of demand functions that is identical to the consumption vector constructed as a solution to the linear programming model, a solution of the whole model is obtained. If not, an iterative process is used until these two vectors are sufficiently similar.

4. The Interpretation of the Model

Under the constraints given by technology, preferences, world market prices and the size of the public sector, the model determines an efficient development path for the economy. In particular, the model determines the volume

³This variable is taken as a proxy for real disposable income.

and structure of the use of energy in the economy. Provided the private sector of the economy is "sufficiently" competitive the solutions of the model could also be given a positive interpretation; a solution of the model could be used as a conditional forecast of the future use of energy in Sweden.

However, it is by no means obvious that this interpretation can be given to the solutions of the model. The model is thus probably best suited for simulation studies, that is, for the study of how and to what extent different assumptions lead to different solutions.

5. Results

The work with this model began in late 1973. By now the electricity sector model is completed and the refinery and private consumption demand models are almost completed. Thus, no final results can yet be reported. According to the time schedule the first version of the complete model will be numerically formulated and ready to be used during the academic year 1975-1976. However, a more detailed description of the model can be obtained upon request from Lars Bergman or Anders Björklund, Stockholm School of Economics, Box 6501, S-11383 Stockholm, Sweden.

References

- [1] Anderson, D. "Models for Determining Least-Cost Investments in Electricity Supply." The Bell Journal of Economics and Management Science, 3, 1 (Spring 1972).
- [2] Bergendahl, G. "Investment and Operation of Electricity: A Multi-Period Cost Minimization Model for Sweden." Working Paper 74-7. European Institute for Advanced Studies in Management. February 1974.
- [3] Bergman, L. "Oil, Energy and the Price Mechanism." Energy and Environment. Paris, OECD, 1974.
- [4] Bergman, L., and Bergström, C. Energipolitik och energianvändning. Stockholm, EFI, 1974.

DiscussionRabar

In the Mäler presentation, what is the relationship between the different submodels? Is it one huge linear programming model? What about the dynamization of the model?

Mäler

Rabar asked about the dynamization of the model. The model is an intertemporal model. For instance, the power industry model shows the relationships each fifth year up to the year 2000, and we have minimized the present value of the cost. The same is true of the overall model. The real engine is the assumption on the exogenous growth of real consumption.

Introduction to Methods Used in the
World Modelling Project
with Special Regard to the Energy Demand

R. Bauerschmidt

The question of energy demand is no doubt an important one, but it is only one of several problems of the same importance dealt with in the World Modelling Project. It would be useful, then, to give a brief overview of the methods used in the project and then discuss the project's applications to the energy model. The project's overall methods may be described by four objectives:

- 1) problem orientation,
- 2) regionalization,
- 3) stratification, and
- 4) scenario analysis.

1) All models yet developed consist of a certain number of submodels which are integrated for the special purpose of concern. Problem orientation means that the complexity of the submodels is only as high as it is meaningful for the problem which shall be analyzed with that special model. For example, in the case of the energy model it is not necessary to include a full population model which is very complex and therefore needs a lot of time and space in the computer, but it is sufficient to use either a simple version of the population model or a table of results from a separate run of the full population model. Another example is the use of a simple form of an energy model for analysis of the food problem. It is obvious that development in the energy field has certain influences on agricultural development, but these are not

as strong as other determinants such as availability of land, investment in the agricultural sector, overall economic development, etc., so that it is sufficient to use a simple energy model for food analysis. The reason for restrictions on problem oriented submodels is, of course, to hold back expenditures on computer runs.

2) Regionalization is necessary for a world modelling effort: on the one hand, you cannot use a unified world view because of the different developments and problems in different parts of the world; and on the other hand, using nations as the units, that is analyzing all countries separately, would increase the efforts for analysis more than tenfold and would give little more information. Therefore, regionalization is a compromise between the two extreme possibilities, global or national. As a basis we have chosen the ten regions you see in Figure 1. The division was made for several reasons, mainly on the basis of geography, economic system, and the similarity of problems coming in the future. We have developed another method of regionalization, which can put each country in different groups depending on the problem of concern. This is an optimizing method which takes into account the similarity of data of some selected variables. This method requires all data on a national basis, and this is available only for some models. For some problems, however, it is not necessary to distinguish among ten regions. In the case of oil, for example, it would be sufficient for some analyses to have the oil-exporting countries, that is region 7, on the one side and the main oil-importing regions, regions 1 to 4, on the other side. The reason is that some regions are self-supplying, such as the socialist countries and Latin America and some consume only a little oil such as Africa and South Asia and therefore have only a little impact on the overall system.

3) The third objective mentioned is the stratification. This means that the whole system of concern is divided

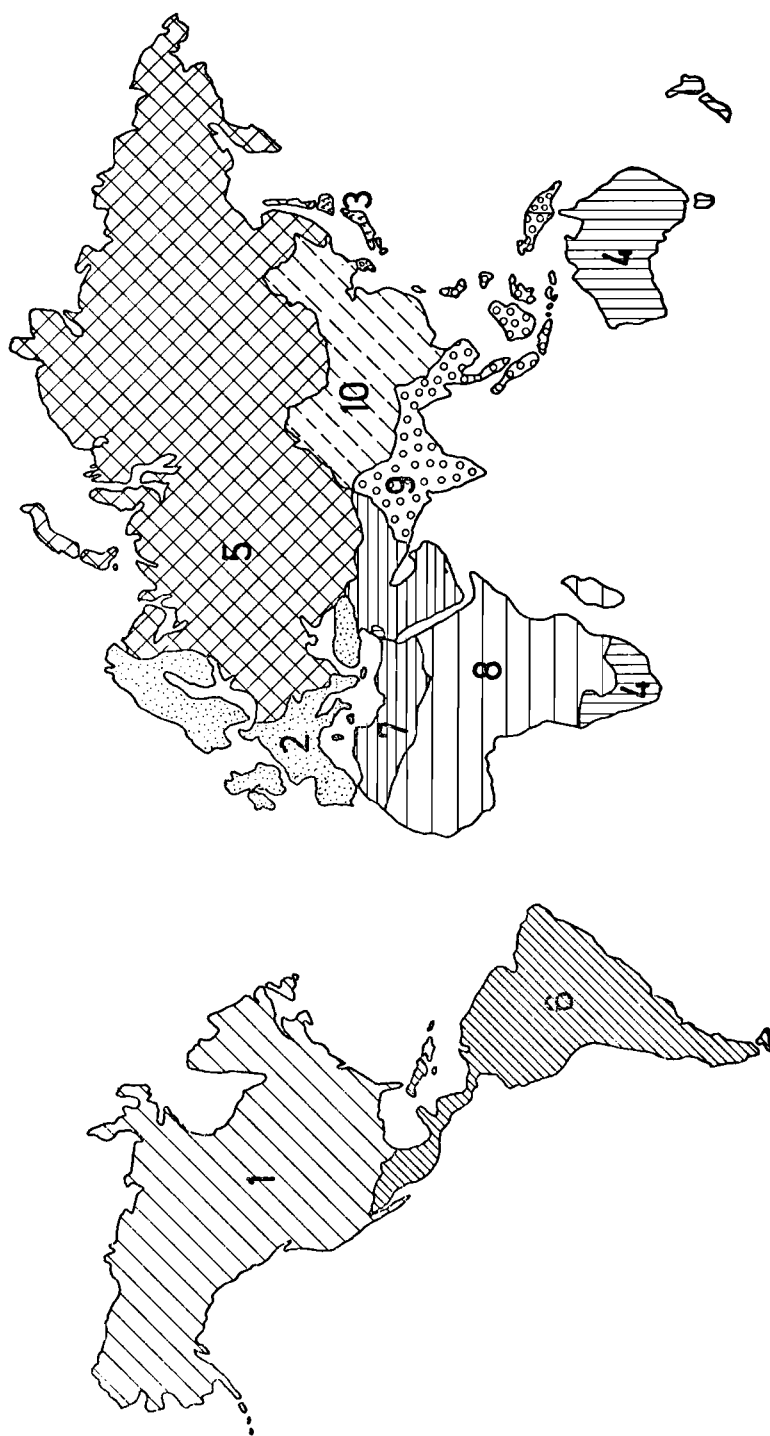

Figure 1. The ten world regions.

in several subsystems which are arranged in a hierarchy. Each level in this hierarchy is termed a stratum and the representation of the entire system is called a "multistrata system" or a "stratified system." The reason for this stratification is the absolute necessity to consider the phenomena and processes of traditional concern in different scientific disciplines when modelling the world system. Normally this problem has been solved by starting from a representation in a given discipline and bringing in the additional factors by an extension within the same context, using known concepts and ideas. The advantage of several hierarchically arranged subsystems is having not only an additional factor or some additional factors, but also a whole subsystem--in space and time--in terms which are used to describe the systems' behavior in different fields containing the main concepts and variables. Obviously, the behavior of the total system is better understood if more strata are identified and analyzed.

The basic stratification which we have adopted for our model of the world system is shown in Figure 2. On the lowest--environmental stratum--changes in the physical environment are represented, such as for example changes in resources and impacts on the ecological environment. The next--technological stratum--embodies all of man's activities described in terms of natural laws: energy and mass transfer. The following stratum--economic and demographic--provides a description of man's activities not in physical terms but in terms of "accounting systems" which are used traditionally in these two fields. It should be pointed out that the technological stratum is "real" while the economic can be viewed as an "artifact." Yet, for an understanding of the world system behavior the economic stratum is perhaps among the crucial, since it provides the basic motivating force for the other strata. Next the "group stratum" embodies various processes and forces governed by and governing the society, for example, population. Finally the "stratum of individuals" represents man, his psychological and biological conditions and constraints.

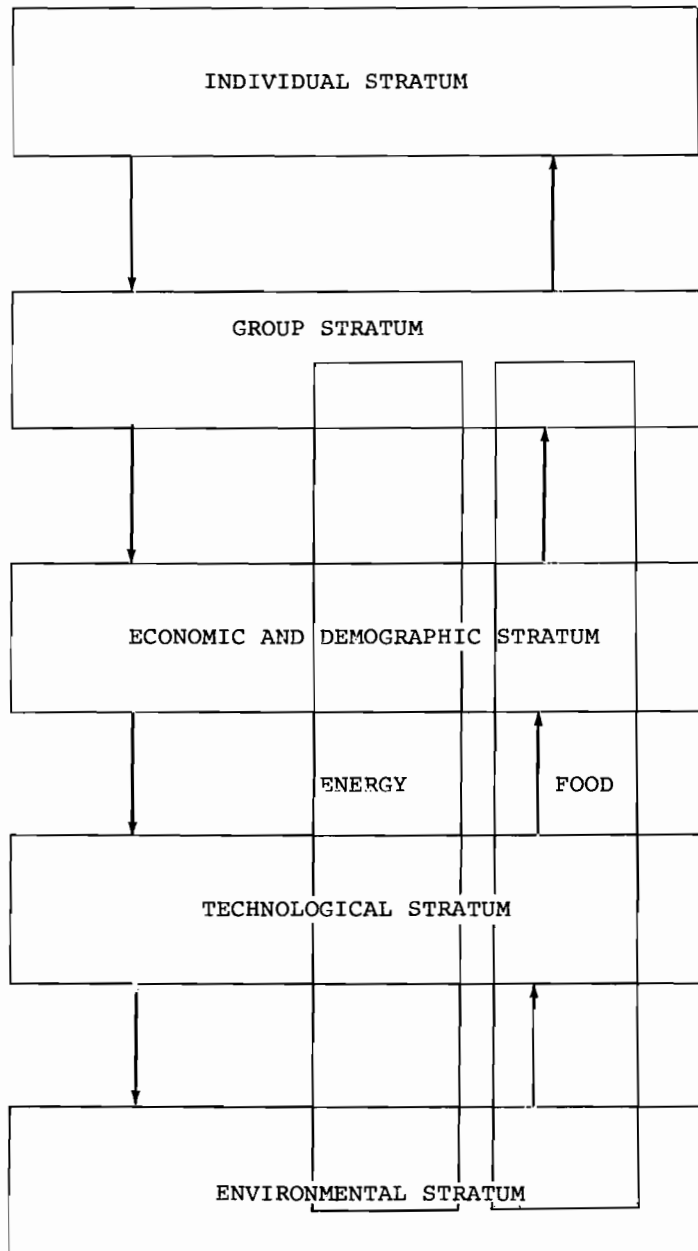

Figure 2. Stratification of the world system.

4) All these subsystems in the different strata and therefore in the world system as a whole cannot and should not be modelled--that is implemented on a computer--fully by means of a closed, self-contained program. This is quite obvious for the higher strata, but to a lesser extent it is true for the lower strata as well. Therefore, a flexible, open-system modelling, which exploits the interactive mode of computer analysis must be used. Such a model is not designed "to predict" the future, but rather to assess the alternative paths of development. Before running the model the user has to specify a set of parameters and variables which either are left unspecified or whose values are only constrained within certain limits. A sequence of such choices which reflects a sequence of possible events is called a scenario. The whole process is the scenario-analysis. Again, four main parts which are shown in Figure 3 can be identified:

- a) model,
- b) parameters,
- c) policy options, and
- d) indicators.

The model is the implementation of variables and relationships on the computer. Some parameters whose values are viewed as somewhat uncertain are defined as scenario-variables and should be specified up to the knowledge of the user. All of them have default values to give a hint of what we would view as plausible. By the way, all other variables, which we did not declare as scenario-variables, can be viewed as such and can be altered as well. With help of the policy options the user is able to analyze desired or expected developments in various areas of concern. These options must be specified as changes over time either in the form of a verbal declaration, which then is transformed for use in the model, or in the form of a curve. The indicators are the window through which the results of the scenario-analysis can be observed. The user can choose the indicators from a huge set of possibilities up to the problem to analyze and his personal interests.

SCENARIO ANALYSIS

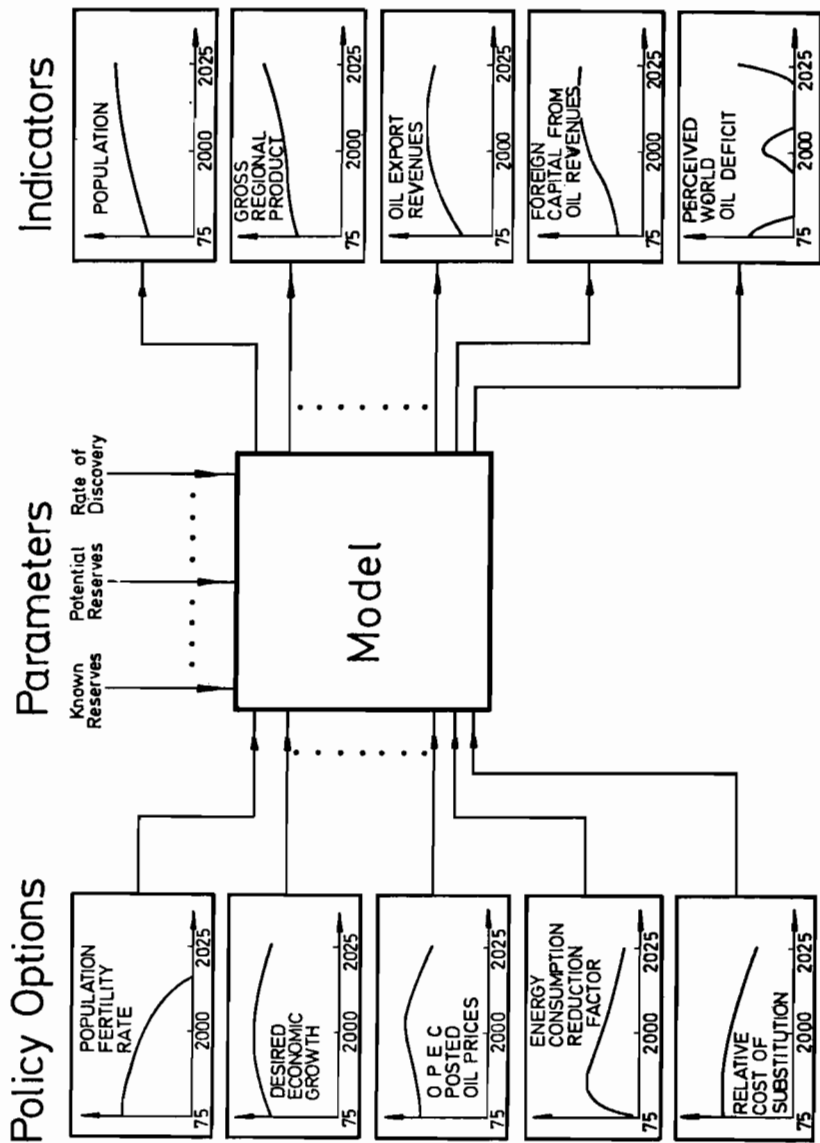

Figure 3. The four main parts of scenario analysis.

In order to facilitate the process of scenario analysis for the user, who normally is not accustomed to the computer and such models, we have developed several scenario sheets which have different levels of complexity. In a demonstration of the model we start with the qualitative level, where the user can choose some parameters and policy options from three alternatives, such as high, medium or low, or fast, medium, slow, etc. Some standard sets are prepared as indicators. This is done for pedagogical reasons to accustom the user to the model and various possibilities of analysis available. In the second stage, scenario sheets on a simple quantitative level are used, then on the extended quantitative level, and so on. This brief overview of the overall methods used in our project should be sufficient to give some information on the possibilities and limits of models of this kind.

Figure 4 shows the main elements of the World Oil Energy Model, given in a hierarchical multilevel structure. Of course there are many interactions between the submodels of the different levels. For example in the question of energy demand, the energy, economy and population submodels clearly interact with each other, because of the size of both the economy and the population in any region, and because of world trade in connection with energy prices; all affect the total energy demand of a region. Similarly the availability and the prices of energy affect the viability of the economy.

Hierarchically superior to these submodels is the institutional level. It is superior in the sense that the policies defined at this level shape all submodels on the lower levels. These systems on the lower level, on the other side, influence and constrain the possibilities of the policies at the top level.

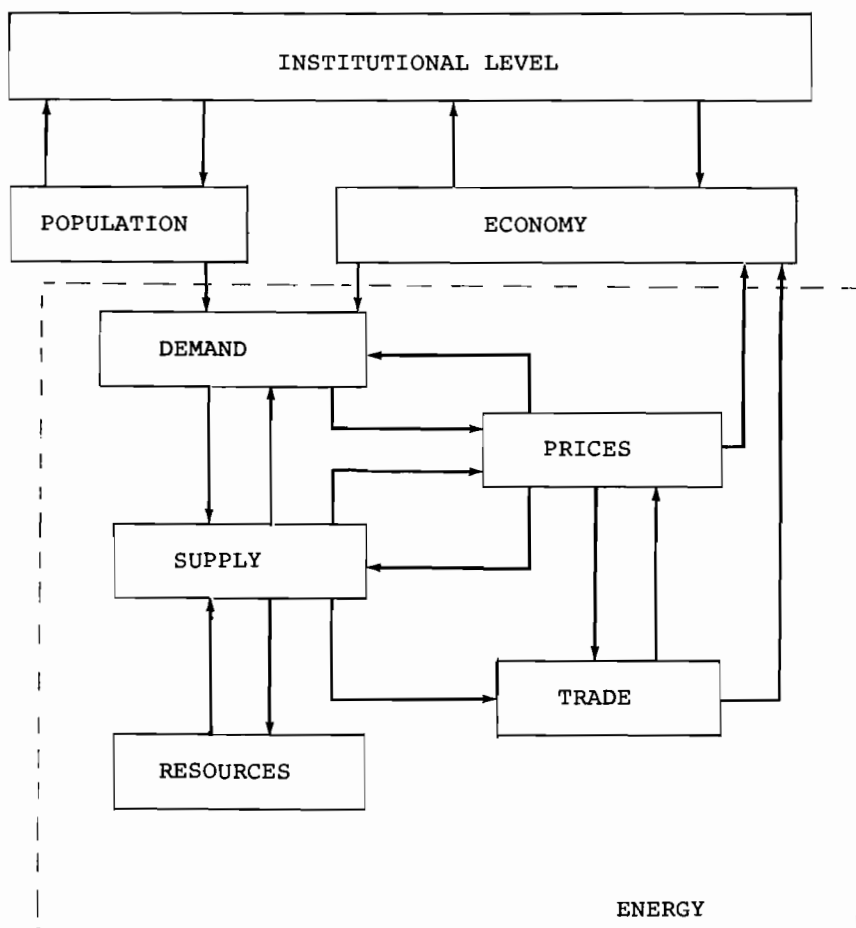

Figure 4. The main elements of the world oil energy model.

The same sort of influences from level to level are found in the environmental submodel, here the resources submodel, on the bottom level with those submodels which are at higher levels.

Except for the trade submodel, all other submodels exist separately for each region. Then the various regions are grouped in importing and exporting regions because the policy options for both groups are quite different from each other. The exporting regions may manipulate the prices and their production capacity and they may spend their revenues in consumption expenditures or in investment in internal economic growth or external capital. The importing regions may try to raise imports, increase efforts for conservation or independence policies or may manipulate the prices for their export goods.

Figure 5 shows the major elements of the oil demand section of the energy model. The first important variable on the demand side is the "base line total energy demand." This is basically a function of the size of the gross regional product (GRP) and the size of the population, but it is more exactly computed from GRP and a factor specifying the relative increase in total energy demand per capita to the increase of the GRP per capita. We have experimented with and used other types of relationships,¹ but we found that this approach gives the best results. The ratio of energy consumption per capita to GRP per capita has been studied by us from the data from 1950 to 1970 and for all regions and is presented in Figure 6.

¹See "Multilevel Computer Model of World Development System," eds. M. Mesarovic and E. Pestel, Proceedings of the Symposium Held at IIASA, Laxenburg, April 29-May 3, 1974, Vol. 4, IIASA SP-74-4 (Laxenburg, Austria, International Institute for Applied Systems Analysis, 1974).

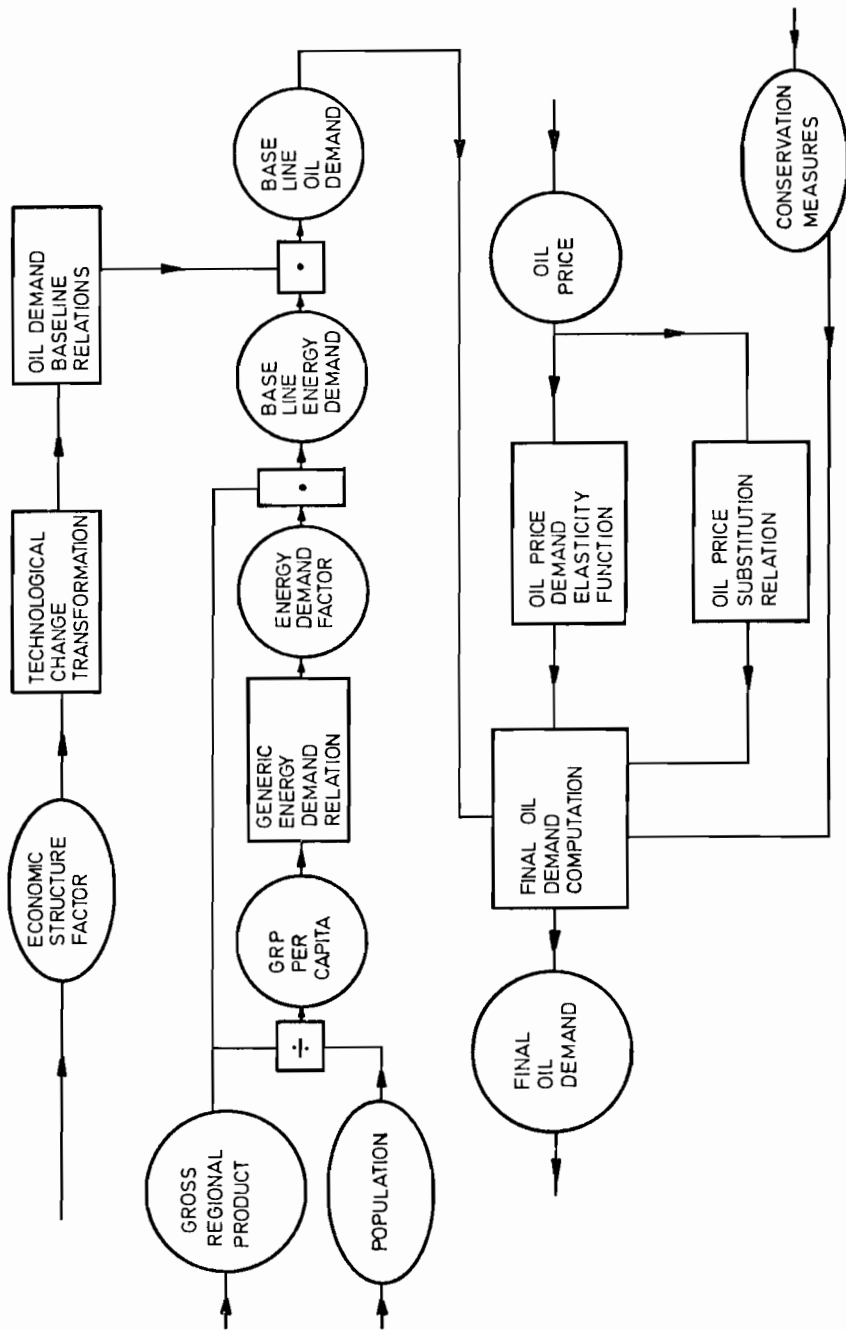

Figure 5. Oil demand submodel.

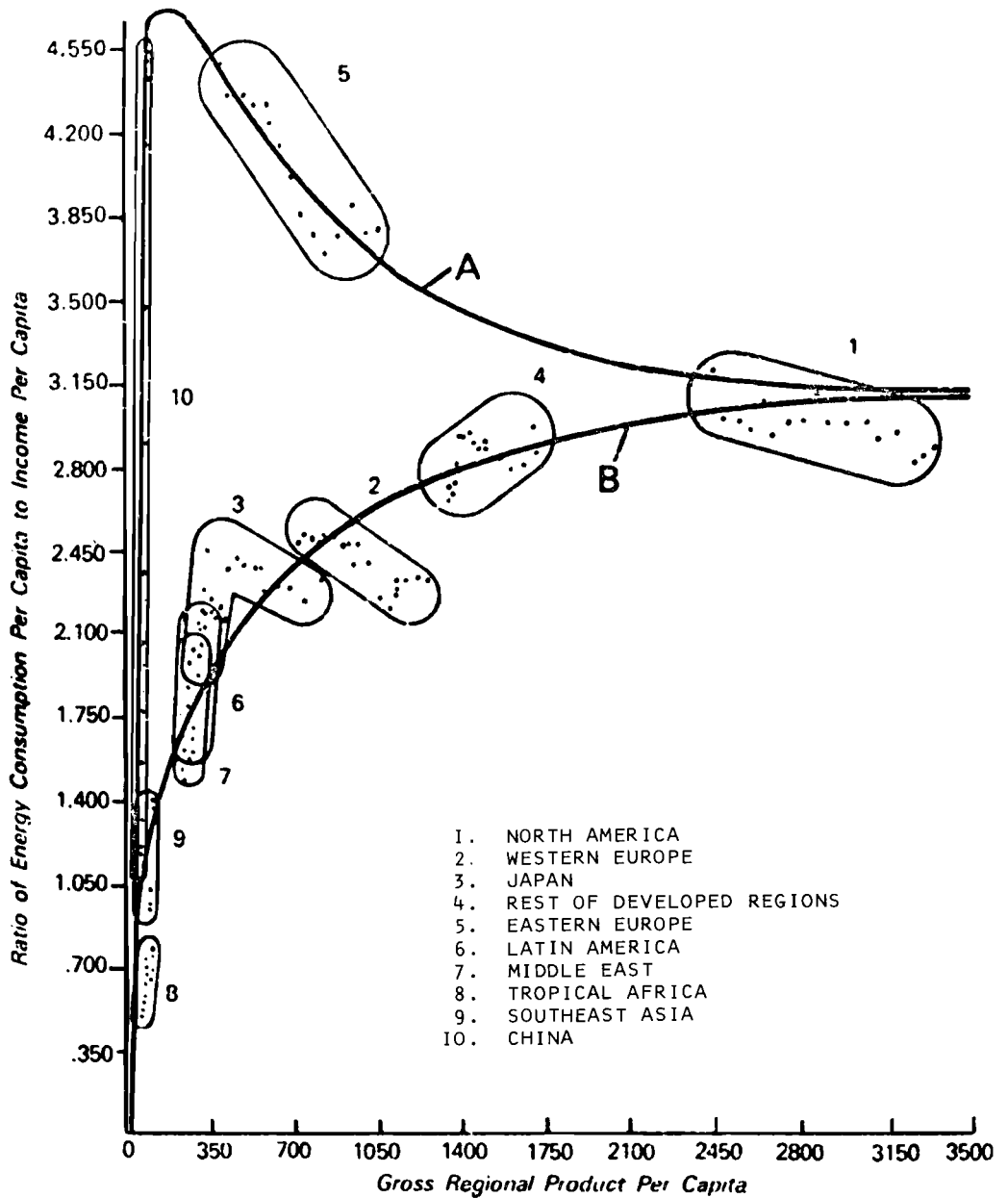

Figure 6. Relationship between energy demand and economic indicators as derived from historical data.

Figure 6 shows that this ratio, also called the energy demand factor, increases from a very low level in the developing regions to a considerably higher level in the economically more developed parts of the world. The reason for this is quite obvious, since the less developed regions have primarily agricultural and fewer industrial activities and thus have a less energy-intensive economy. Moreover, these regions import some highly energy-intensive goods, like fertilizers and capital goods. As soon as regions increase their industrialization they have to use more energy relative to the increase in their GRP, and as they move from industrial to service economies this development stabilizes.

Two regions do not fit in this general pattern: China, and the Soviet Union together with the other socialist countries of Eastern Europe. This is the result of political decisions which led in both regions to emphases on a very rapid development of heavy industry and therefore a very rapid consumption of energy in relation to the overall economy. But the development in region 5 shows that this ratio diminishes as soon as the economy begins to shift increasingly to light industries, consumer goods and services.

Returning to our discussion of Figure 5, we have seen how to determine the base line total energy demand. The base line oil demand now is a certain proportion of the total energy demand.

Historically this proportion has increased ever since the beginning of oil production. But surely this increase will not and cannot last forever. As soon as resources become scarce, the prices for oil will rise, and as soon as other, cheaper, energies become available, this proportion will fall. It is given in the model

either just as an initial parameter or as a curve varying with time. Underlying this curve is an analysis by the Institute of Gas Technology in Chicago described in several studies by the Institute. These approaches are, of course, from among many possible hypotheses, and therefore in a further energy model now in development we have used a quite complex system of splitting total energy demand into demand for the several energy carriers. This splitting process takes into account availability, prices, environmental impacts, technology and some policy options.

After the base line for oil demand is found, either with help of the described curve or as a constant proportion of the total base line energy demand, this demand is altered by influences of conservation policies, prices and substitution. The influences of policies of both conservation and substitution are introduced gradually and are felt as a decrease in the proportion of oil demand in the total demand. The influence of the oil price will be felt in two ways. First, there is a direct change of demand with changing prices. Economists call this the "own elasticity" of a commodity. Secondly, in addition to this own elasticity there is "cross elasticity," which means that other energy types will be substituted for oil as soon as the price of oil increases and passes the point at which other fuels are competitive. This "cross elasticity" is almost more potent than the "own elasticity."

It should be mentioned that all the policies and elasticities are scenario variables, so that with the energy model the numerous possibilities of these variables and their impacts on other parts of the whole model can be tested.

Discussion

Rabar

At the second approach we have seen a submodel of a global modelling effort, the Mesarovic-Pestel model. The paper touched much more on the philosophy than on the substance. The presentation did not deal too much with the details how these models really interact and what is the connection between the strata, the regions, and the problem orientation. The problem is how these things interact. What is the real interaction? The expectations, which were raised by the general discussion about the approaches, led to a certain disappointment when the Mesarovic-Pestel world model was presented. I have even preserved the notes which I made at that time, and it is interesting to read them. The first point was that I did not see any direct substitution among the primary energy materials inside of one region. The second point is that no direct interaction exists between supply and demand because what they had is a time series of aggregated demand which is generated by the demand model and enters as a time series in the supply model. The third point is that the structure of demand, the technology embodied in the users' equipment, is not represented at all. So the structural shifts in the demand forces the economy to adjust through aggregate output, since there is no direct interaction between energy and other sectors of the economy. So in spite of the good intentions, in spite of the complex approach which was presented, the actual model which we have seen did not contain those features which were expected.

Ross

I would like to make a comment generally that I had hoped to see more at this Workshop of the sort of relationships which Bauerschmidt was discussing. I would like to emphasize a few of the relationships between what he called the environment

stratum, the technological stratum, and the demographic and economic stratum in the hopes that I might convince the economists to pay a little more attention to these interactions.

Bauerschmidt

I want to make two remarks on the comments of Rabar. The first is that I mostly dealt with the overall method and not so much with the energy demand sector, because we have heard over the last two days very detailed studies on energy demand and very little about a systems approach. And, as you cannot be more complex in global modelling than those who are dealing just with this subject, I preferred to stress the overall method, especially the normative component of it. The second is that Rabar was disappointed about the details of our models when we presented them last year at IIASA. He mentioned that we had just three energy submodels: resource, demand, and supply, but no real integration. But in addition to these three submodels, last year we presented another model, the integrated oil model, which indeed connected various fields of concern, such as population, economy, and the energy sector though just on a two-component basis, oil and non-oil. In the meantime we have integrated the then presented submodels in a multisector energy model, which is not yet published because we still have to make some tests with the model.

Hutber

Global models are terribly complex and it is quite clear that from the computational point of view that a global model must not be too complex, otherwise it will be too expensive to run and too technical to use. The way we have dealt with this in the UK is to run what I like to call orthogonal models so that in our integrated system of models, national models, we have models which analyze small parts of the system in very much greater detail. For example, we run a combined electricity and coal investment model which is what I would call a simple model. That is, it is a point model, but we back it up having

an electricity model which is a regional model taking into account the position of power stations and their connections. Similarly, for coal, we have built a point model into the investment model, but we have a regional model for describing the details of coal investment. Now it is very important that these models be consistent with one another so they can be considered as orthogonal or, if you like, cross-sectional model data on the main stream of the model. The other observation is on Rabar's point that in global models we are bordering on philosophy rather than policy. I would like to try to explain that by saying that, as far as the national models are concerned, policy is the end product because whoever is running the models has control over the parameters. In the UK, we have control over three out of four of our energy industries so we are very nearly in the position where we can determine policy absolutely on the basis of models run. But where do you get with world global models, especially the world regional models? You are into philosophy because there is no way to optimize a global model of the real world. There is no way of implementing any policy it throws up. So our attitude towards global models has been to look and see what is the best thing for the world but realize that we cannot implement it and see what the consequences are of nations optimizing their own area.

The Real Limits to Growth

W. A. Ross

Introduction

The question of limits to human population growth on this planet is one of utmost importance today. If there are real limits which have become effective or will do so in the very near future it is important that we understand why they arise, how they manifest themselves and what we can or cannot do with them.

One effort to discuss this subject resulted in the book The Limits to Growth¹ which presented the results of a rather complex computer model of world dynamics. The results are essentially that within the next fifty to 150 years, in the absence of rapidly implemented controls on growth sufficient to stabilize both population and resource consumption, some form of catastrophe will result. This work has been extensively, and often unconstructively, criticized because its results are model-dependent.²

For this reason I approach the topic in a very general fashion in the present paper. I attempt to demonstrate the existence of unavoidable limits to growth which, given present trends must manifest themselves within the next 100 years. Moreover, I attempt to do so in a model-independent way, the arguments being based solely on fundamental conservation principles.

¹D.H. Meadows, D.L. Meadows, J. Randers, and W.W. Behrens, The Limits to Growth (Universe Books, 1972).

²Perhaps the severest criticism of The Limits to Growth comes from John Maddox in The Doomsday Syndrome (McGraw Hill, 1972).

Before commencing the analysis of limits to growth, I first present some important features of geometric growth. These features are discussed in the next three sections and cover the following material:

- 1) some more instinctive and less mathematical ways of understanding large populations;
- 2) some general properties of geometrical growth; and
- 3) some derivative properties of geometrical growth.

The following two sections present the critical discussion of how natural resources provide the real limits to growth.

Interpreting Large Numbers of People

The objective of this section is to point out the importance of understanding the meaning of large numbers of human beings. To do this let me list some populations. The world population is about 3.8 billion; the North American population about 290 million; Canada's population is just over twenty-two million, Alberta's population is about 1.7 million; Calgary's population is about 430,000; the University of Calgary has a "population" of about 10,000 to 15,000 and most of our classrooms have a population of about thirty. Now, taking these populations in the reverse order, it is clear that we can readily appreciate the meaning of a population of thirty. We can even know all of them by name. If we consider populations of about 15,000, we can often relate to that many people by virtue of having seen that many people in one place at one time--large Canadian football stadiums, for example, hold up to twice that number. However, while we may have seen as many as 30,000 people together at one time, I submit there is no appreciation on a human scale of who all those people are. Indeed, simply counting those people at the rapid rate of one per second would take one full eight-hour day.

But what about the larger populations? Mathematics has allowed us to understand the number 3.8 billion but on the basis of the above comments it seems clear that we cannot claim to understand the meaning of this number of human beings. Mathematics provides us with a very powerful tool. For example, in discussing the world's future population we could write sixteen billion, or in mathematical notation 16×10^9 . But we could just as easily write sixteen trillion or 16×10^{12} and the only difference is that the nine exponent becomes a twelve (or the word billion is changed to the word trillion). Yet sixteen trillion people spread out over the land area of the earth would have an average of only ten feet square each to stand in, and if we casually change the number to 160 trillion = 160×10^{12} people, the entire land area would be covered with people standing shoulder to shoulder.

But enough of trillions. The point is that one must not be casual with large numbers when they represent people; one must try to understand some of the consequences of population figures. Let us return to our present population of 3.8 billion and its current 2% per annum growth rate. This implies that every year there are seventy-six million more people than the previous year; every second there is a net gain of two more human beings (three are born, one dies). While 2% per year may not be too threatening a growth rate, certainly seventy-six million people per year is quite mind-boggling.

Since these large numbers of people are so difficult to comprehend, what about the (smaller) population of Calgary--430,000 people? One consequence of such a population can be seen by the following simple calculations. Under the (conservative) assumption that each of these people consumes two and one-half pounds of food per day, one can readily see that the entire city consumes over one million pounds of food daily. If this food were imported into the city by trucks each carrying an average of one ton of food, then

more than 500 trucks bring food into Calgary every day of the year.³ Food, of course, is only one of many resources used, but this approach of evaluating the consequences of certain populations is a useful way of comprehending the population size.

Some General Properties of Geometric Growth

It is important to gain an appreciation of geometric or exponential growth. This form of growth is characterized by a constant per capita growth rate which implies that the rate of growth increases with increasing population. This form of growth is fairly typical of many present forms of growth. For example, the world's population is growing at the rate of 2% of its current value each year, man's use of energy is growing at about 5.7% of its value each year, and electricity use in Alberta is increasing at about 10% per year. Figure 1 is a graph of "population" (in arbitrary units--people, barrels of oil, kilowatt-hours, or whatever) versus time for a 5% per annum growth rate. The population starts at one and goes off the graph (i.e., becomes bigger than 2,500 units) after about 160 years. This feature of exponential growth is quite well-known: the population curves tend to run off the graph paper rather quickly. This could be remedied, of course, by choosing a bigger piece of graph paper--say ten times as long vertically. The result is shown in Figure 2 which has a vertical scale which runs up to 25,000 units. It is essentially the same but instead of taking 160 years, it takes just over 200 years. The problem is that when the population concerned represents the human population on earth (which is of finite size) running off the graph paper (which is of finite size) results in disaster.

³Of course 100 trucks per day each carrying five tons of food will also provide the appropriate amount of food. These figures are probably more appropriate.

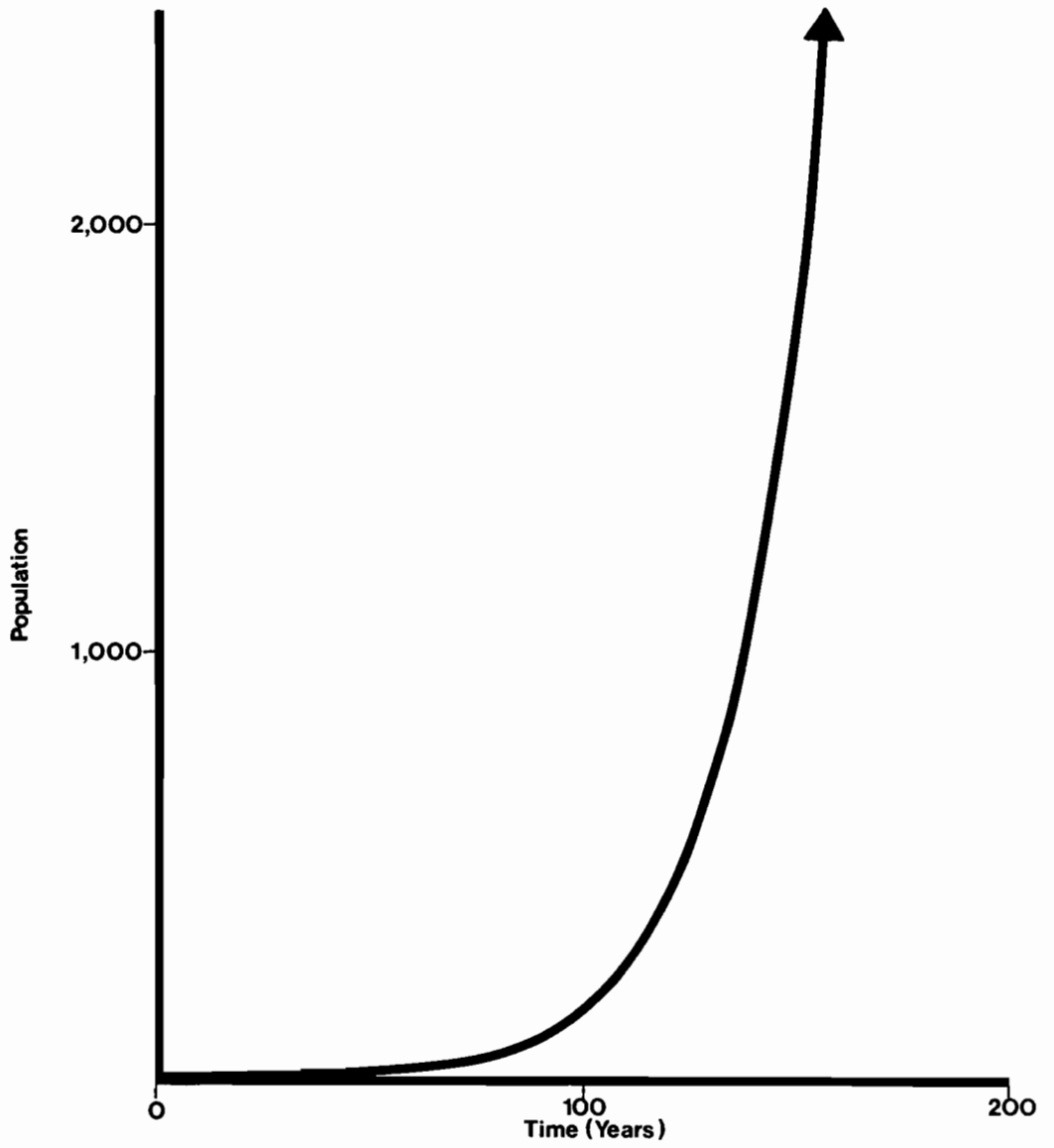

Figure 1. Geometric population growth (5% per year growth rate).

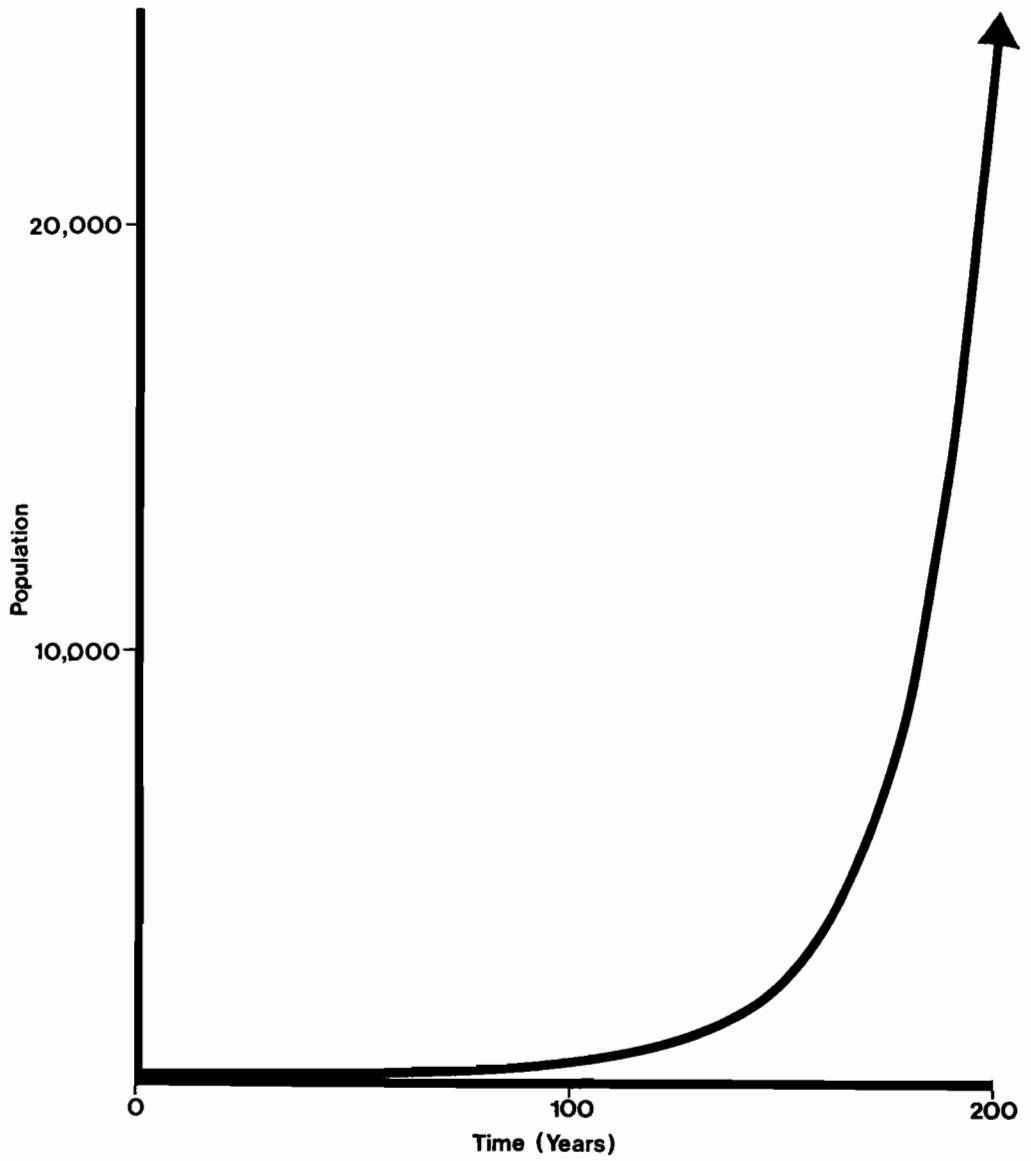

Figure 2. Geometric population growth (5% growth rate per year).

Keeping these results in mind, let us now consider the following rather silly but instructive projections based on our current population of 3.8 billion people and a 2% per annum growth rate. In 500 years the population would be 160 trillion people (as already noted the people would then be shoulder to shoulder over the entire land surface of the earth). At that time Calgary's population, prorated, would be nearly four times the present world population. Just fifty years later the people would be shoulder to shoulder over the total world's surface (land and water) assuming they learn to stand on water. In just over 1,500 years the mass of the people on earth (assuming sixty kg per person) would be equal to the mass of the earth itself--i.e., the entire mass of the earth will have been converted to human flesh. The ultimate in population growth occurs about 4,600 years from now when the mass of the people on this earth will be equal to the mass of the entire universe, that is the entire mass of the universe will have been converted to human flesh.⁴

Now, while these projections are clearly nonsensical, they have been presented for two reasons. First, they clearly establish that a growth rate of 2% per annum is utterly impossible even for an extremely short period of geological time. Secondly, they demonstrate that a limit to growth does exist, and that the time scale for the approach of that limit is not far off on a historical

⁴The mass of the universe is obtained by using the experimentally observed (average) mass density of 3.5×10^{-31} grams per cubic centimetre in combination with the radius of the universe which is 1.7×10^{10} light years. These figures come from: J.R. Gott III, J.E. Gunn, D.N. Schramm and B.M. Tinsley, "An Unbounded Universe?" Astrophysical Journal, 194, 3, part 1 (n.d.), 543.

time scale. Moreover, if we consider current plans for managing the long-lived radioactive wastes from nuclear reactors,⁵ then this time frame for limits to population growth is shorter than our current planning time frames. Having established that a limit exists, I shall later return to provide a better estimate of when the limit will manifest itself.

The Quickening Pace of Geometric Growth

There is another feature about geometric growth which seems not to be so widely appreciated as those discussed in the last section. This is the phenomenon of a quickening pace--things happening more quickly--as time goes on. (A mathematician would simply observe that the derivative of an exponential function is itself essentially the same exponential function.) This phenomenon can be seen graphically in the following fashion. Imagine the "population" in Figure 1 to represent houses needed by people living in a certain area. Then each increase in this "population" by 250 means 250 houses must have been built. Figure 3 indicates the time taken for each increase in "population" of 250 houses. Thus the first 250 houses must be built in 110 years, the next 250 houses in fourteen years, the next in eight years, then 5.8 years, then 4.5 years, and so on. In fact it should come as no surprise that the rate is a curve which looks exactly like this total house curve (but with a different vertical scale); it too represents exponential growth. The point is that, as time

⁵See W.M. Campbell, "Waste Management in the Nuclear Power Program" (AECL- CNA- 73-303, 1973), and W. Bennet Lewis, "Radioactive Waste Management in the Long Term" (AECL- 4268, October 1972). It is clear from these documents that radioactive wastes must be managed for periods of about 10,000 years, perhaps as long as hundreds of thousands of years, and in no event less than 2,000 years.

goes on, not only does the population increase more and more quickly, but the rate of change of this growth increases in exactly the same manner.

For example the population of the world is now about 3.8 billion and has a doubling time of about thirty-five years.⁶ The current rate of increase of this population is two more human beings per second (net). Going back two doubling times to 1905, we find a population of less than one billion and a (net) rate of change of this population of one person every two seconds. Going ahead two doubling times to 2045 we would find a population of about fifteen billion and a (net) rate of change of eight persons per second.

While these time scales are a bit too long to take simply at face value, we can consider other forms of growth such as electricity consumption. In many parts of North America this has been growing for some time with a growth rate of 6% to 10% per annum. Selecting a growth rate of 7% per annum which has a convenient doubling time of ten years, let us see what happens in a region which now has sixteen generating stations. In ten years (one doubling time from now), with generating stations of constant size, there must be thirty-two stations and so the stations must

⁶Exponential growth is also characterized by having a doubling time (the time taken for the population to double in size) which is independent of the population size. This doubling time is related to the annual growth rate by:

$$T_2 = \frac{0.693}{AGR}$$

where T_2 is the doubling time in years and AGR is the fractional annual growth rate. Thus an annual growth rate of 2% has a doubling time of $T_2 = 0.693/.02 = 34.6$ years.

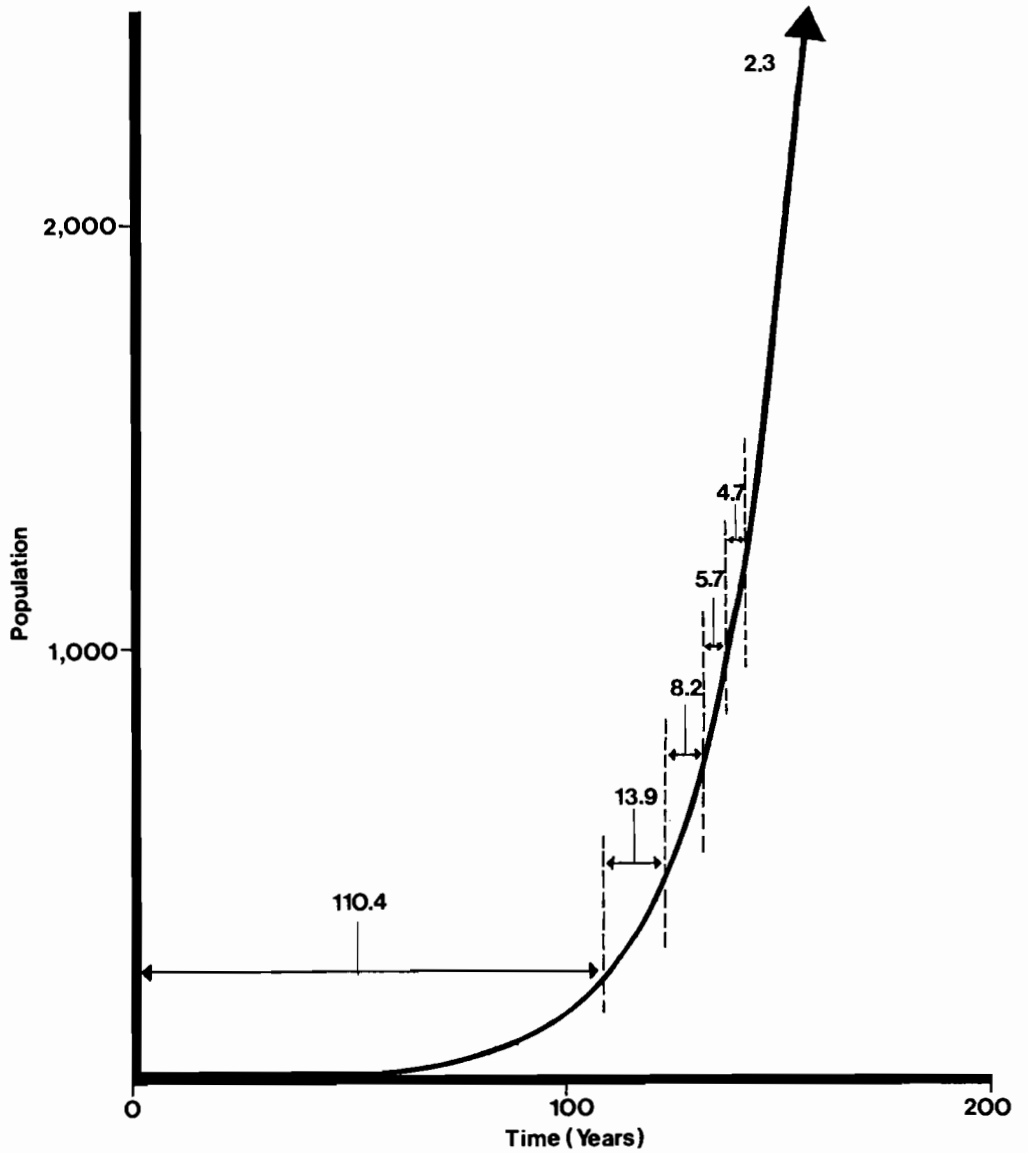

Figure 3. Geometric population growth (5% per year growth rate) indicating times needed for population to increase by 250.

be built at the rate of 16/10 or 1.6 stations per year (one new station every seven to eight months) for the next ten years. Twenty years ago there were only four stations in existence and the rate of construction of new stations was one every 2.5 years. Twenty years from now it is generally appreciated that sixty-four stations will be required but it is not so well appreciated that the construction rate will be one new station every two months.

These examples demonstrate that the exponential growth function has as its consequence not only the rapidly growing "population" but also the fact that related activities occur at a rate which grows equally as fast--the quickening pace phenomenon. Next I shall consider two examples of exponential growth in the world today and examine how the properties discussed above manifest themselves.

The first example is that of a finite non-renewable resource such as oil or natural gas. The analogue of the finite size of the graph paper is simply the finiteness of the resource: we can never extract more of the resource than exists.⁷ Since oil and natural gas use has experienced something not at all unlike geometric growth, the graphs of Figures 1, 2 and 3 are essentially the sort we are dealing with, and running off the graph corresponds to exhausting the resource. The corresponding quickening pace is indicated by an exponentially increasing rate of extraction of these resources. The high rates of exploration and extraction simply reflect this quickening pace phenomenon. The high rates of other activities in these industries reflect the realization of the approaching edge of the graph paper and the realization

⁷In spite of general belief to the contrary no amount of manipulation by oil companies, economists, or finance ministers can alter this fact.

of the rate at which this edge is approaching. The argument that there is more of the resource available is indicative of the difference between Figure 1 and Figure 2 (there is a factor of ten difference and a 5% per annum growth rate).

The other example is illustrated in Figure 4 which shows the electrical energy statistics for the Province of Alberta for the period from 1950 to 1970. Indicated are the annual consumption of electricity (in billions of kilowatt hours) and the total generating capacity (in millions of kilowatts) as well as the generating capacity added yearly.⁸ The growth rate here is about 10% per annum extending over more than three doubling periods. Of course the cumulative generating capacity grows with the consumption curve, but it should be noted that the yearly added capacity also increases sharply with time (the quickening pace phenomenon).

Natural Resources as a Limit to Growth; General

Having gained an understanding of some important consequences of growth, we can proceed to examine some of the more important implications on resource management. I shall first consider a particular resource of some importance--food.

The fact that the earth is able to produce only so much food has some obvious consequences. First, let us make the (simplistic) assumption that the food grown per unit area of land is a constant and consider the consequences of the above observations about geometric growth. If we are to feed everyone, the amount of food produced annually must grow exponentially as does the population (assuming a constant per capita food requirement). Thus the amount of

⁸See Alberta Energy Resources Conservation Board, "Cumulative Annual Statistics Alberta Electric Industry" (ERCB 73-28, 1973).

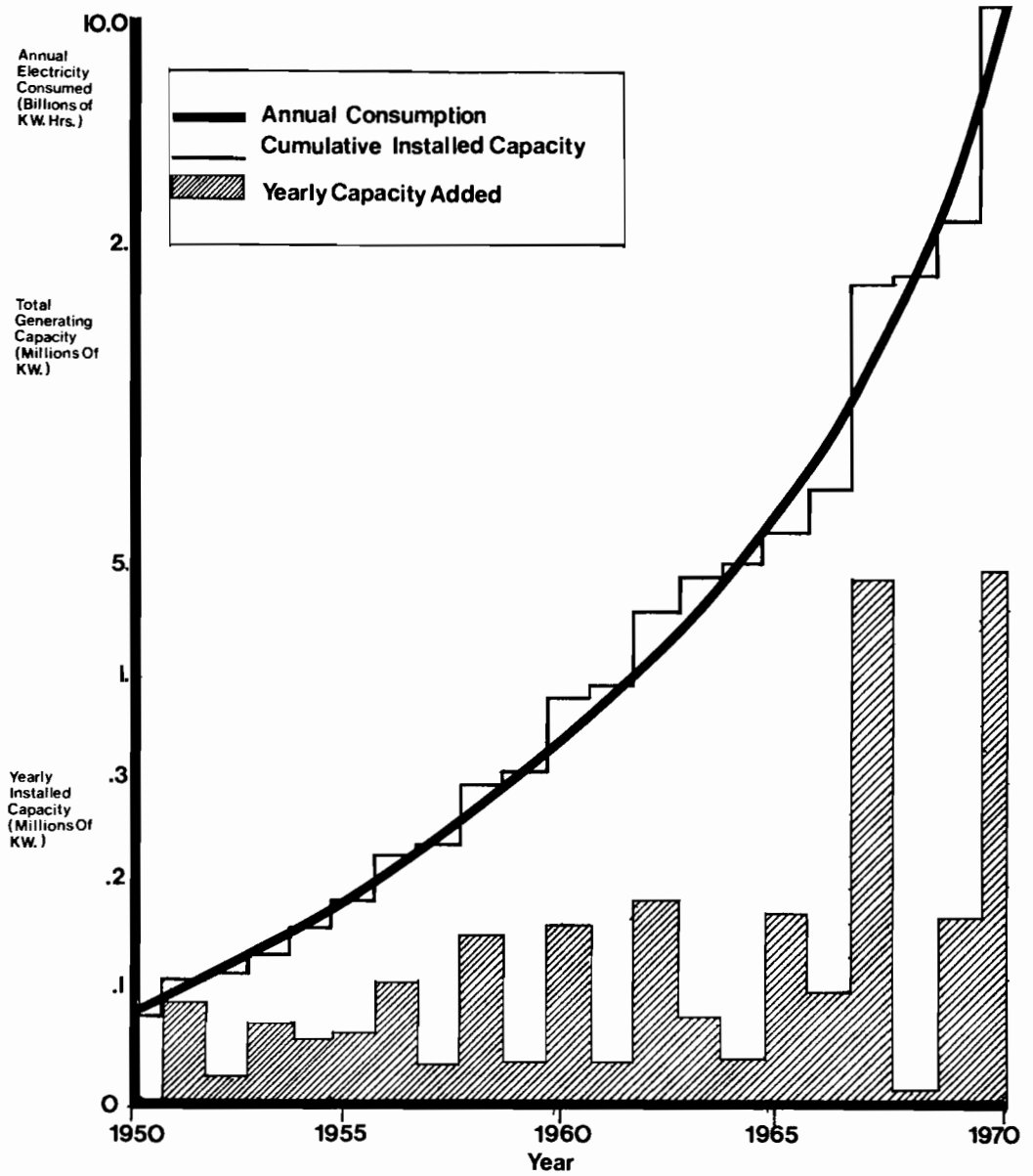

Figure 4. Alberta electric energy statistics versus time.

farmland as a function of time will look like Figure 1. Secondly, the rate of increase of farmland (i.e. the amount of new farmland which must be brought into production each year) will also look like Figure 1. Since this is transparently nonsense if applied over any extended period of time (because of the finite amount of arable land surface in a finite world) we must relax our assumption of constant productivity. It then follows that, with a finite amount of arable land, our ability to extract food from the land must grow like the curve in Figure 1, as must our ability to improve.

To see how this works in detail consider the following bit of simple arithmetic. At any time let the amount of food which we produce (globally) be F (kilograms per year). Let us attempt to design for a population of P (people) each of whom we shall feed a total of not less than V (kilograms per year of food). The first observation is that, in order to have a chance of success we must have

$$F \geq P.V \quad .$$

Moreover, if the system of food distribution is inefficient or inequitable so that not all of F gets distributed evenly but only some fraction of it does, say α ($0 < \alpha \leq 1$) then we must have

$$\alpha.F \geq P.V \quad .$$

This equation simply states that the food which we can produce and distribute must be at least as large as the food we are required to consume.

Now α is a characteristic of our society and is bounded above by one (i.e. cannot in principle be larger than one), F is a characteristic of the world and of our technological abilities at the time, but is also bounded above, and V reflects our values but is bounded below by physiological characteristics of human beings, i.e. cannot in principle be smaller than some minimum value.⁹ So the one remaining free parameter in our design is P , which must satisfy

$$P \leq \frac{\alpha \cdot F}{V} ,$$

i.e. if we are to achieve this design of feeding our population we have an upper bound on its size--a limit to growth.

It is true that we can increase the bound on population by increasing α or F or by decreasing V . But α may never exceed 1; F is bounded above by some limit, F_{\max} , and V has a lower bound, V_{\min} , so in any case

$$P \leq \frac{1 \cdot F_{\max}}{V_{\min}} .$$

It is worthy of note that if we want to live the "good life" by which I mean live with lots of resources (V larger than is truly necessary, not having to maximize α too carefully), then we can do so provided we have a small enough population.

⁹In this respect one needs to consider not just a single measure of food intake such as caloric value but several nutrient contents as well (e.g. animal protein). Moreover, it is important to appreciate the distinction between the minimum food required to sustain life and that necessary to allow for optimal physical and intellectual development. The latter requirement is considerably more demanding both in quantity and in quality than the former.

This is of course the way it has been in the past. The population was sufficiently below the natural limit $\frac{1 \cdot F_{\max}}{V_{\min}}$

that we could afford to overconsume ($V > V_{\min}$) and be sloppy or inequitable with our distribution system ($\alpha < 1$) and we did not need to press the system to produce maximum food ($F < F_{\max}$).

Here we see one of the important consequences of growth. We are forced to be much more careful with resources ($\alpha \rightarrow 1$); we are forced to consume less of them per capita ($V \rightarrow V_{\min}$); and we are forced to produce as much of them as possible ($F \rightarrow F_{\max}$).

This analysis, while done for food, clearly applies, after a fashion, to any resource used by man. These conclusions are not particularly deep and can be seen to be in operation today. Applied to energy consumption for example, the distribution is being more carefully controlled (rationing); the amount consumed per capita is being driven down (turn down the thermostats); and more efforts at production are being made.

The fact that this analysis obtains for any resource is of some importance in designing for a certain population size. The procedure is to determine some acceptable "quality of life" as measured by the per capita consumption of the appropriate resources.¹⁰ Then the population P must simultaneously satisfy

¹⁰Here I am discussing specifically the contribution of per capita resource consumption to quality of life. While this is a significant contribution it is by no means a complete measure of quality of life. Elsewhere in this paper the term quality of life is intended to be more general and to include other elements such as those related to individual freedoms and life-style options.

$$P \leq \frac{\alpha_i \cdot F_i}{V_i}$$

for all i . Here α_i is the efficiency of distribution, F_i the yearly rate of extraction, and V_i the yearly per capita consumption all for the i - th resources.¹¹ Considering all i simply means considering all resources consumed. The one resource for which $\frac{\alpha_i \cdot F_i}{V_i}$ is the smallest is the limiting resource for the population.

Should P fail to satisfy any one of these inequalities then either the population must be reduced so as to satisfy that inequality or else the mode of life designed for must be altered (α_i or F_i must be increased or V_i must be reduced). Increasing α_i or decreasing V_i is, in some way, a form of increased restriction on our life-style: it forces us to be more equitable and efficient in dealing with the resource, or forces us to consume less of it. In this respect it can be (and usually is) regarded as a way of decreasing the quality of our life.

However, increasing F_i has not been so regarded, and so it has been the preferred approach to expanding the constraints on man of limiting resources. The finiteness of resources puts definite limits on this solution. These limits may simply reflect a supply which cannot in principle be augmented (such as exhaustion of a non-renewable resource) or they may involve the undue increase of extraction rates which simply changes the nature of the problem. The current debate over coal strip-mining procedures in North America is an example of these limits manifesting themselves long before

¹¹Simply i is an index of the resources, e.g. $i = 1$ - food; $i = 2$ - water; $i = 3$ - air; etc.

there is an absolute limit to the coal resource.^{12,13} In this case another resource becomes limiting--the land itself and the trade-off between the two is an important feature. This sort of competition for resources such as air, water, space, energy, or materials is quite common. Another example is the use of water in the western United States. It can be used¹⁴ to mine coal or to irrigate cropland for food production, but it is not in sufficient supply to do both. The point here is simply that our biosphere is a complex system and that at some point we cannot increase exploitation of a limiting resource or else we will generate enough environmental stress to make another resource limiting. The extent of technological improvement possible to increase the supply of a resource is limited. A particularly important example of this is discussed in the next section.

Energy Resources as a Limit to Growth

It has been argued that there are many resources involved in a reasonably satisfying life-style each of which provides a limit to population growth. The only fashion in which these limits to growth can be removed, other than by reducing the quality of life, is to expand production of the appropriate resources. In today's world this clearly involves an expanded use of technology to accomplish these aims. The essence of most technological innovation is

¹²See Alberta Environment Conservation Authority, "Report of the Ad Hoc Subcommittee on Coal Exploration in the Eastern Slopes to the Co-ordinating Committee of the Public Advisory Committee on the Environment" (September 24, 1974).

¹³See US National Academy of Sciences, Rehabilitation Potential of Western Coal Lands (Ballinger Publishing Co., 1974).

¹⁴See Julian McCaull, "Wringing Out the West," Environment, 16, 7 (September 1974), 10.

energy. Thus, if energy consumption is bounded, then so also is the extent of improvement due to technology. On the earth energy certainly is bounded. Essentially it is limited to the energy we receive from the sun. Again it might be argued that technology can save us, that there exist virtually inexhaustible supplies of nuclear energy (e.g. deuterium fuel for fusion). But this energy source is more apparent than real. The reason is that there are constraints on total energy use on the earth resulting from the laws of thermodynamics. Simply put, if we produce significantly more heat energy (in the end virtually all energy used by man assumes this form) then the earth (the ultimate sink for the heat energy) will warm up. Once the climate on a global scale becomes seriously altered (say the mean temperature is increased by more than a few degrees Celsius) then the continued survival on this planet of billions of human beings becomes a very serious question. This "embedding" of man-made energy production in the earth's climatic system is an important feature nicely discussed by Häfele.¹⁵ The detailed consequences of attempting to embed more and more energy production in the climatic system are by no means well understood. Some, in order of increasing severity are: a) local alteration in rainfall patterns (now a well established feature in highly industrialized urban regions); b) alteration of climatic conditions (primarily in terms of rainfall and evapotranspiration) over larger areas; and c) global climatic modification. Häfele claims that a $1^{\circ} - 2^{\circ}\text{C}$ change would be significant (see Häfele in footnote fifteen above). Thus the first effect of man-made power density increases is likely to be a modification of the hydrological cycle, e.g. heating of lakes and rivers, altering rates of evaporation, changing rainfall patterns. If enough power is produced, the problem then becomes one of global temperature, melting of polar ice caps. This clearly implies that the natural limits to man's use of energy is potentially of utmost importance.

¹⁵See W. Häfele, "A Systems Approach to Energy," American Scientist, 62, 4 (1974), 438.

The reasons for this most important role being played by energy are, to reiterate, twofold. First, a large number of resource shortage problems can be dealt with only by the application of large doses of technology which in turn require energy for their implementation. Secondly, the absolute amount of energy which can be produced by man without an obvious and serious risk of severe damage to the earth is limited by fundamental scientific laws.

Before proceeding to more detailed estimates of this particular limit to growth, it is appropriate to provide some specific but important examples. These are found in connection with food production. In the last few years (since 1970) intensification of cultivation, raising the output on existing cultivated area, has accounted for 80% of the annual growth in world food output whereas expansion of the cultivated area accounted for only 20% of the growth in food production. In the future it is likely that intensification of cultivation will play an even larger role in expanding food production. This will happen at least partly because of pressures on agricultural land for competing uses such as recreation, transportation, and industrial and residential development.¹⁶ Few countries have land use policies that effectively protect agricultural land from other uses.¹⁷ One of the most important consequences of

¹⁶See Lester R. Brown, In the Human Interest (W.W. Norton and Company Inc., 1974), pp. 47, 48.

¹⁷A few European countries which have been short of agricultural land for some time (such as the Netherlands) have some such controls. The Canadian provinces of British Columbia, Prince Edward Island, and Alberta are also now making efforts to preserve agricultural land. However, to illustrate the total lack of previous efforts in Alberta we can examine the growth of its capital. In the seven year period 1966 to 1973 urbanization of the area around Edmonton claimed 25,000 acres of land. Of this land 41% was classified as class 1 soil, 25% class 2, and 19% class 3. This information comes from the Fall 1974 edition of Agriculture Bulletin, University of Alberta. Soil in Canada is classified in seven groups according to its agricultural suitability by the Canada Land Inventory. Class 1 is the best agricultural land in the country, class 7 is the worst.

intensification of agricultural production is a several fold increase in energy requirement. Energy is required for seed bed preparation, weeding, irrigation, production and application of fertilizer and pesticides, and for harvesting the heavier crops. In addition, the energy costs of transporting, processing, and storing food produced in this fashion are considerable.¹⁸ A concrete example of amounts of energy involved is the projection¹⁹ that by the year 2000, 800 billion kilograms of nitrogen fertilizer would be needed. The energy required to produce this much fertilizer is over 20% of the present world energy use. Another good example of the energy requirements of modern agriculture is that fossil fuel subsidies exceed the energy in the food produced by about 5:1 whereas in "primitive" agricultures the ratio is more like 1:20 or 1:50 (see steinhart and Steinhart in footnote eighteen above).

Another way in which technological improvements could aid increased food production could be through the provision of irrigation water for fertile but arid agricultural land. One way of doing this is by desalination of seawater--another technological solution requiring significant amounts of energy. According to Lovins, "under reasonable assumption[s], desalinating enough seawater to grow one average man's subsistence crops could well require as much energy as he now uses for everything" (Lovins, p. 18).

Next consider the sort of time frame over which energy can expect to show up as a serious limit to growth (that is, when the energy use will be enough to produce a few degrees Celsius change in the world's temperature). If we try to accommodate a population of thirty billion people (the population which would be achieved in 100 years at present

¹⁸ See, for example, John S. Steinhart and Carol E. Steinhart, "Energy Use in the U.S. Food System," Science, 184, 4134 (April 19, 1974), 307.

¹⁹ Amory B. Lovins, "World Energy Strategies", Bulletin of the Atomic Scientist, 30, 5, 6 (May and June 1974).

growth rates) and to provide it with the same per capita energy consumption as Canadians today enjoy, then the human power production would be 0.3% of the net solar radiation at the earth's surface.²⁰ This amount of energy would produce a small temperature change of about 0.3°C. However, as has been pointed out, in view of the other resource shortages certain to arise in the next century²¹ the per capita energy requirement necessary to maintain the present Canadian quality of life is certain to grow considerably. To estimate the extent to which this energy requirement will grow we can turn to the current per capita energy growth rate in Canada--3.4% per annum. If we assume that the main portion of this--say 2.5%--is needed for the expanding technology necessary to maintain our present standard of living throughout the next century then the energy requirements of our thirty billion people in the year 2075 become 3.6% of the solar insolation which would produce a temperature increase of

²⁰This assumes 200 W/m² as the year round average insolation averaged over the earth's entire surface and a Canadian per capita average power requirement of 10 kw--about four or five times as much as the average person on the earth. For the rest of this paper this net solar radiation at the earth's surface is called the solar insolation.

²¹Dennis L. Meadows and Donella H. Meadows, Toward Global Equilibrium: Collected Papers (Wright-Allen Press, 1973). See pages 294-297. Among other things it is noted that, for current growth rates, even assuming five times the current known reserves, the following resources have projected lifetimes of less than sixty-five years: aluminum (fifty-five), copper (forty-eight), gold (twenty-nine), lead (sixty-four), mercury (forty-one), natural gas (forty-nine), petroleum (fifty), silver (forty-two), and zinc (fifty). See Steinhart and Steinhart in footnote eighteen, Lovins in footnote nineteen, and Meadows here, for other examples of ways in which energy-demanding technological solutions will be required to alleviate resource shortage.

2.5 to 5.0°C.²² Moreover, this global averaging masks local effects which could be very severe. This increase in temperature is clearly serious (see Häfele, footnote fifteen above) and is in all probability a true limit to growth. To see that this amount of energy is also not inconsistent with current energy growth rates in the world today we can also project the current world energy consumption (of eight trillion watts) ahead 100 years at the current annual growth rate of 5.7%.²³ This results in 2.4% of the solar insolation, just slightly below the above figure, that is the current trends in world energy consumption are indeed heading toward the above design. It is interesting to note that using the full 3.4% growth in per capita Canadian energy demand yields 9% of solar insolation and temperature increase of 6°C to 12°C. These results

²²This calculation is based on balancing the heat energy added to the earth with the energy radiated out to space by the earth. The energy radiated by the earth is determined by the earth's temperature (to the fourth power) and if the energy added to the earth is increased then the earth's temperature must increase in order to increase the amount radiated (and so restore a balance). In addition to this there is the water vapour greenhouse coupling described in SMIC, pp. 114, 137. This effect could double the increase in temperature for a given increase in energy input (see SMIC, p. 137) and so the range of temperature increases given is as follows: 2.4°C--no greenhouse effect, 5.0°C--a greenhouse effect which doubles this increase. See SMIC (Study of Man's Impact on Climate), Inadvertent Climate Modification, M.I.T. Press, 1971.

In this connection it is worthy of note that different energy sources have markedly different effects on heat added to the earth. Solar energy, if utilized without major changes in the albedo of the earth's surface, could be a source of very little or no increase in heat. The same comments are true for tidal power, wind power, geothermal power, and hydro power although these sources are not capable of playing major global roles as energy sources. However, the use of fossil fuels, nuclear fission (breeders or not), or nuclear fusion will all result in all of the energy generated being excess energy.

²³See Lovins, footnote nineteen above, p. 16.

may in fact be more credible in view of the increased rate of resource shortages which will occur in the future. Perhaps even higher growth rates should be utilized if the energy required for food production is any guide. However, a profound ignorance of the way in which the world's climatological system functions for such large perturbations casts considerable doubt on the accuracy of the 6°C to 12°C temperature increase. In any event, this level of heat release would certainly produce a major global climatic change.

This means, quite clearly, that the earth cannot in principle, support a population of thirty billion in the manner in which we live in Canada today. A limit to growth has been demonstrated which will become operative within the next century. Essentially we have reached the stage where population and quality of life (as measured by resource consumption) are inversely related--where $P.V = a \text{ constant}$. We can only increase the population, P , by a corresponding reduction in the per capita resource consumption, V .

DiscussionRabar

And now I would like to turn to the Ross paper which is also very interesting. I think that basically you are told two things. One is what large numbers and geometric growth really mean--how they are perceptible. In the second part, Ross argued that some upper limits to consumption exist. The attempt to prove that these limits exist was, in a certain sense, trivial because I do not think that anybody would really doubt the existence of some outer limits. The problem is finding where the outer limits lie, and it is quite sure that we will reach the real limits long before we reach, for instance, the thirty billion population which was mentioned in the paper. So, if we say that the population was limited by two variables, by the food production and by the per capita food consumption--and of course we can change both--then the real question is how far can we change these two variables--rather than prove that there is an outer limit for both.

Consumer Demand for Energy

Dale W. Jorgenson¹

1. Introduction

Consumer demand patterns for energy are a critical component of any analytical framework for the quantitative assessment of alternative US energy policies. Policy issues that involve demand patterns include the impact of energy prices on energy conservation, the effect of energy on the composition of demand for products of the non-energy sectors of the economy, the role of economic growth in determining the rate of increase in demand for energy, and the importance of shifts in preferences in the allocation of consumer expenditures between energy and non-energy products.

As an illustration of a policy assessment for which consumer demand patterns are critical, we can consider the imposition of an excise tax on energy consumption. Such a tax creates a wedge between the price paid by the energy consumer and that received by the producer. If demand is unresponsive to price changes, the primary consequence of imposition of such a tax is an increase in energy prices paid by consumers. On the other hand, if demand is price responsive, an excise tax can induce conservation of energy by consumers and can reduce the overall level of energy utilization.

¹Harvard University and Data Resources, Inc. I am indebted to Laurits Christensen and Lawrence Lau for helpful advice, to Christopher Chamley, Ronald Hurdelbrink and Kenneth Train for expert research assistance, and to the National Science Foundation for support through Grant GI-43097. All responsibility for any remaining deficiencies in the final product rests with the author.

An alternative measure to reduce energy demand is to impose a tax on energy-using equipment, such as automobiles. The effectiveness of such a tax depends on the cross elasticity of demand for energy with respect to a change in the price of energy-using equipment. Similarly, a possible side effect of policy measures to induce energy conservation is to alter the composition of the demand for non-energy products. The impact on specific non-energy products depends on cross elasticities of demand with respect to changes in energy prices.

Quantitative assessments of alternative energy policies require a complete model for the allocation of personal consumption expenditures. Such a model must include measures of price and income elasticities of demand for energy. It must also include cross-price elasticities of demand between energy and non-energy products. Finally, it must incorporate the effects of preference changes as well as the effects of income and price changes in determining the pattern of consumer demand. Of course, complete policy assessments require the analysis of both demand and supply determinants of energy prices and utilization.

The purpose of this paper is to analyze consumer demand for energy within a complete model for the allocation of US personal consumption expenditures.² Our concept of personal consumption expenditures differs from the corresponding concept in the national accounts in two respects.³ First, we

²Our model of personal consumption is one component of a new econometric model for the analysis of US energy policy. A report on the model is contained in Jorgenson [7]. For a recent review of econometric studies of consumer demand for energy and detailed references, see Taylor [15].

³A detailed reconciliation of our concept of personal consumption expenditures and the national accounting concept is given by Christensen and Jorgenson [2], pp. 331-348.

define the consumption of consumers' durables as a flow of services rather than an investment expenditure. Expenditures on consumers' durables are treated as part of gross private domestic investment rather than personal consumption expenditures. We add an imputed flow of services from consumers' durables to personal consumption expenditures, so that our concept of durables services is perfectly analogous to the national accounting concept of housing services.

The second important difference between our concept of personal consumption expenditures and the concept employed in the US national income and product accounts is that we evaluate all expenditures at producers' prices. Trade and transportation margins are treated as separate items of consumption. In the US national income and product accounts all components of personal consumption expenditures are valued at prices paid by consumers. Trade and transportation margins are included in the prices paid. Our accounting conventions coincide with the conventions used in compiling inter-industry transactions accounts for the United States.⁴

The primary objective of our research is to characterize the pattern of consumer demand empirically. We wish to assess the impact of changes in total expenditures and changes in preferences on the allocation of expenditures among commodity groups. We also wish to determine the pattern of substitution. We take the hypothesis that demand functions are generated by utility maximization as an assumption rather than a hypothesis to be tested. Under this hypothesis cross price effects on demand are constrained by symmetry restrictions. These symmetry restrictions enable us to incorporate

⁴For a reconciliation between the national income and product concept of personal consumption expenditures and the inter-industry concept, see Simon [14] and the references listed there.

into our model of consumer demand for energy the cross-price effects between energy and non-energy products relevant to quantitative assessments of energy policies.

2. Model

In this paper we present the results of our research for a model of consumer expenditure allocation among capital services (K), energy (E), and non-durables (N).⁵ The services of capital include housing services and the services of consumers' durables. The stock of housing and consumers' durables corresponds to the stock of energy-using equipment and structures. Energy includes all types of energy--electricity, petroleum products, coal, and gas. Non-durables consumption includes all other items in the consumer budget. Prices and quantities consumed for each of the groups are index numbers computed from prices and quantities consumed of commodities included in the group.⁶

Our model for the allocation of personal consumption expenditures is based on a complete system of demand functions. Each demand function gives the quantity consumed for one of the commodity groups as a function of total expenditure and the prices for all commodity groups. Our approach to the analysis of consumer demand avoids the imposition of restrictions on expenditure allocation beyond those implied by the hypotheses of utility maximization and the existence of the

⁵In our econometric model a total of eleven commodity groups is distinguished in personal consumption expenditures. We have aggregated these groups through a series of five submodels into the three aggregates listed in the text. A detailed report on our results for the submodels is presented in Jorgenson [7].

⁶We have used index numbers that are exact for the model of consumer behavior presented below. For further discussion of these index numbers, see Christensen and Jorgenson [1] and Diewert [5].

three aggregates--capital services, energy and non-durables. Taking these hypotheses as assumptions, we propose to estimate all the unknown parameters of our complete demand system simultaneously.

Given the hypothesis of consistency between our system of demand functions and the maximum of utility and the grouping of commodities into three aggregates, we could proceed to impose further constraints on the allocation of personal consumption expenditures, such as constant price and income elasticities of demand or constant elasticities of substitution among commodity groups.⁷ However, such an approach would frustrate our primary research objective of characterizing the pattern of consumer demand empirically. This approach would convert hypotheses about budget allocation and patterns of substitution into assumptions rather than hypotheses to be tested.

Given utility maximization, we can exploit the duality between price and quantities in the theory of consumer demand. This theory implies the existence of an indirect utility function defined on total expenditure and the prices of all commodities.⁸ Utility increases with total expenditure and decreases with the price of each commodity. Proportional changes in all prices and total expenditure leave the consumers' budget unchanged, so that utility can be expressed as a function of the ratios of prices of all commodities to total expenditure. The practical importance of the indirect utility function arises from its usefulness in deriving the implications of utility maximization for a complete system of demand functions.

⁷Systems of demand functions with these properties are discussed by Christensen, Jorgenson, and Lau [3].

⁸For further discussion of the indirect utility function, see Lau [9] and the references given there.

We represent the indirect utility function by a function that is quadratic in the logarithms of ratios of prices to total expenditure and time. The introduction of time as a variable in the indirect utility function permits preferences to change with time. The resulting indirect utility function provides a local second-order approximation to any indirect utility function with time-varying preferences. We refer to our representation of the indirect utility function as the indirect transcendental logarithmic utility function or, more simply, the indirect translog utility function with time-varying preferences.

The indirect translog utility function in a form independent of time was introduced by Christensen, Jorgenson and Lau [3]. This indirect utility function has been employed by them to test the theory of demand and to determine the structure of consumer preferences. Lau and Mitchell [11] and Christensen and Manser [4] have employed a homothetic form of the indirect translog utility function to analyze the structure of consumer preferences. The indirect translog utility function with time-varying preferences was introduced by Jorgenson and Lau [8]. In addition to testing the theory of demand and determining the structure of consumer demand, they have used this indirect utility function to analyze changes in the structure of preferences over time. Our analysis of the structure of consumer preferences and shifts in preferences over time employs the methodology developed by Jorgenson and Lau.

An indirect utility function with time-varying preferences can be written in the form:

$$\ln v = G\left(\frac{P_K}{M}, \frac{P_E}{M}, \frac{P_N}{M}, t\right),$$

where

P_K, P_E, P_N : prices of the three commodity groups--
capital (K); energy (E), and non-
durables (N)--equal to 1.000 in 1958;

K, E, N: per capita quantities consumed of the three
commodity groups;

t: time, equal to zero in 1958;

$M = P_K K + P_E E + P_N N$: per capita total expenditure.

Utility is non-increasing in the prices, so that the logarithm of utility is non-increasing in the logarithms of the prices. A necessary and sufficient condition for monotonicity of the logarithm of the indirect utility function at a particular point is that the budget shares are non-negative at that point. The indirect utility function is quasi-convex, so that the logarithm of this function is quasi-convex. Monotonicity and quasi-convexity of the logarithm of the indirect utility function embody the basic assumptions of the theory of consumer demand.

We approximate the logarithm of the indirect utility function by a function that is quadratic in the logarithms of the ratios of prices to the value of total expenditure and time:

$$\ln V = \alpha_0 + \alpha_K \ln \frac{P_K}{M} + \alpha_E \frac{P_E}{M} + \alpha_N \frac{P_N}{M} + \alpha_t \cdot t \\ + \frac{1}{2} \left[\beta_{KK} \left(\ln \frac{P_K}{M} \right)^2 + \beta_{KE} \ln \frac{P_K}{M} \cdot \ln \frac{P_E}{M} + \dots + \beta_{tt} \cdot t^2 \right] .$$

Using this form for the indirect utility function, we obtain the following expressions for the budget shares:⁹

⁹These expressions follow from Roy's Identity; see Roy [13].

$$\frac{P_K^K}{M} = \frac{\alpha_K + \beta_{KK} \ln \frac{P_K}{M} + \beta_{KE} \ln \frac{P_E}{M} + \beta_{KN} \ln \frac{P_N}{M} + \beta_{Kt} \cdot t}{\alpha_M + \beta_{MK} \ln \frac{P_K}{M} + \beta_{ME} \ln \frac{P_E}{M} + \beta_{MN} \ln \frac{P_N}{M} + \beta_{Mt} \cdot t} ,$$

$$\frac{P_E^E}{M} = \frac{\alpha_E + \beta_{EK} \ln \frac{P_K}{M} + \beta_{EE} \ln \frac{P_E}{M} + \beta_{EN} \ln \frac{P_N}{M} + \beta_{Et} \cdot t}{\alpha_M + \beta_{MK} \ln \frac{P_K}{M} + \beta_{ME} \ln \frac{P_E}{M} + \beta_{MN} \ln \frac{P_N}{M} + \beta_{Mt} \cdot t} ,$$

$$\frac{P_N^N}{M} = \frac{\alpha_N + \beta_{NK} \ln \frac{P_K}{M} + \beta_{NE} \ln \frac{P_E}{M} + \beta_{NN} \ln \frac{P_N}{M} + \beta_{Nt} \cdot t}{\alpha_M + \beta_{MK} \ln \frac{P_K}{M} + \beta_{ME} \ln \frac{P_E}{M} + \beta_{MN} \ln \frac{P_N}{M} + \beta_{Mt} \cdot t} ,$$

where

$$\alpha_M = \alpha_K + \alpha_E + \alpha_N ,$$

$$\beta_{MK} = \beta_{KK} + \beta_{EK} + \beta_{NK} ,$$

$$\beta_{ME} = \beta_{KE} + \beta_{EE} + \beta_{NE} ,$$

$$\beta_{MN} = \beta_{KN} + \beta_{EN} + \beta_{NN} ,$$

$$\beta_{Mt} = \beta_{Kt} + \beta_{Et} + \beta_{Nt} .$$

We note that the parameters α_t and β_{tt} have no effect on the utility-maximizing quantities consumed. These two parameters cannot be identified from data on prices and quantities. The budget constraint implies that:

$$\frac{P_K^K}{M} + \frac{P_E^E}{M} + \frac{P_N^N}{M} = 1 ,$$

so that given the parameters of any two equations for the budget shares, the parameters of the third can be determined from the definitions of $\alpha_M, \beta_{MK}, \beta_{ME}, \beta_{MN}$ and β_{Mt} . Since the equations of the budget shares are homogeneous of degree

zero in the parameters, normalization of these parameters is required for estimating. A convenient normalization for the indirect translog utility function is:

$$\alpha_M = \alpha_K + \alpha_E + \alpha_N = -1 \quad .$$

If the equations for the budget shares are generated by utility maximization, the parameters $\beta_{MK}, \beta_{ME}, \beta_{MN}$ and β_{Mt} appearing in each equation must be the same. Symmetry of the Hessian of the indirect utility function gives rise to symmetry restrictions that take the form:

$$\beta_{KE} = \beta_{EK} \quad ,$$

$$\beta_{KN} = \beta_{MK} - \beta_{KK} - \beta_{EK} \quad ,$$

$$\beta_{EN} = \beta_{ME} - \beta_{KE} - \beta_{EE} \quad .$$

Given the seven equality and symmetry restrictions, there are eleven unknown parameters remaining to be estimated.

To summarize: We have derived a model for the allocation of personal consumption expenditures from an indirect translog utility function with time-varying preferences. We take the hypothesis of utility maximization to be an assumption rather than a hypothesis to be tested. Utility maximization implies that the parameters of equations for the budget shares satisfy equality and symmetry restrictions that enable us to reduce the number of unknown parameters to eleven. These parameters are further constrained by certain inequalities that embody monotonicity and quasi-convexity restrictions on the indirect utility function. We estimate the parameters of our model of consumption subject to the equality and symmetry restrictions; at a later stage we can incorporate the monotonicity and quasi-

convexity restrictions.¹⁰

3. Preference Structure

The primary objective of our research is, first, to determine the effects of changes in total expenditure and changes in preferences on the allocation of the consumer budget between energy and non-energy commodities and, second, to determine patterns of substitution between energy and non-energy commodities. For this purpose we have divided the consumer budget into three categories--the services of energy-using equipment and structures (K), energy (E), and the remainder of the non-durables (N) portion of the budget. We next consider restrictions on the structure of preferences and on changes in preferences among these three commodity groups. Since we wish to avoid imposing restrictions on the allocation of personal consumption expenditures beyond those implied by the hypothesis of utility maximization, we take additional restrictions on preferences as hypotheses to be tested rather than assumptions to be imposed.¹¹

The first restrictions on preferences we propose to test are groupwise separability restrictions. An indirect utility function V with time-varying preferences that is groupwise separable in capital services (K) and energy (E) from non-durables (N) can be written in the form:

$$\ln V = G[\ln V^1(K, E, t), N, t]$$

where the function V^1 depends only on capital, energy and time

¹⁰ Monotonicity and quasi-convexity restrictions are discussed by Lau [10].

¹¹ For derivation of the restrictions on the indirect translog utility function given below, further discussion, and references, see Jorgenson and Lau [8].

and $\ln V^1$ is non-increasing and quasi-convex in capital and energy. A necessary and sufficient condition for groupwise separability of the indirect utility function in capital and energy from non-durables is that the ratio of the budget shares for capital and energy is independent of the price of non-durables. An indirect utility function that is groupwise separable in capital services and energy from time can be written in an analogous form with the role of non-durables (N) and time (t) interchanged. A necessary and sufficient condition for groupwise separability in time is that the ratio of the budget shares for capital and energy is independent of time.

Each pair of commodities, such as capital and energy, can be separable from the remaining commodity, non-durables, or from time. Corresponding to the three pairs of commodities, there are six possible sets of groupwise separability restrictions. Given groupwise separability of capital and energy from non-durables the parameters of the indirect translog utility function must satisfy the restrictions:

$$\beta_{KN} = \rho_N \alpha_K \quad ,$$

$$\beta_{EN} = \rho_N \alpha_E \quad ;$$

similarly, given groupwise separability from time the parameters must satisfy:

$$\beta_{Kt} = \rho_t \alpha_K \quad ,$$

$$\beta_{Et} = \rho_t \alpha_E \quad .$$

Analogous restrictions must hold for any one of the six possible types of groupwise separability. Each set of two restrictions involves the introduction of one new parameter-- ρ_N and ρ_t in the examples given above. Under each set of restrictions, ten unknown parameters remain to be estimated.

The translog approximation to a groupwise separable indirect utility function is not necessarily groupwise separable. If the indirect translog utility function itself is groupwise separable, we say that it is explicitly groupwise separable. For explicit groupwise separability of capital and energy from non-durables, we require the groupwise separability restrictions given above and the additional restriction:

$$\rho_N = 0 \quad .$$

Similarly, explicit groupwise separability of capital and energy from time requires the additional restriction:

$$\rho_t = 0 \quad .$$

Analogous restrictions must hold for any one of the six possible types of explicit groupwise separability. Under each set of restrictions, nine unknown parameters remain to be estimated.

The second type of restrictions on preferences we propose to test are homotheticity restrictions. First, we consider overall homotheticity of preferences. An indirect utility function V with time-varying preferences that is homothetic can be written in the form:

$$\ln V = G \left[\ln H \left(\frac{P_K}{M}, \frac{P_E}{M}, \frac{P_N}{M}, t \right), t \right] \quad ,$$

where H is homogeneous of degree one in the ratios of prices to total expenditure-- $\frac{P_K}{M}$, $\frac{P_E}{M}$, and $\frac{P_N}{M}$. Under homotheticity the budget shares for all three commodities depend only on prices and are independent of total expenditure. Under homotheticity the parameters of the indirect translog utility function satisfy the restrictions:

$$\beta_{MK} = \sigma \alpha_K \quad ,$$

$$\beta_{ME} = \sigma \alpha_E \quad ,$$

$$\beta_{MN} = \sigma \alpha_N \quad .$$

We introduce one new parameter, σ , so that these restrictions reduce the number of parameters by two, leaving nine parameters to be estimated.

The translog approximation to a homothetic indirect utility function is not necessarily homothetic. If the indirect translog utility function is homothetic, we say that it is intrinsically homothetic. If the parameters of the indirect translog utility function satisfy homotheticity restrictions given above and the additional restriction:

$$\sigma = 0 \quad ,$$

this function is homothetic. We refer to these restrictions as the explicit homotheticity restrictions. Under these restrictions only eight unknown parameters remain to be estimated.

An indirect utility function V with time-varying preferences is homogeneous if it can be written in the form:

$$\ln V = \ln H \left(\frac{P_K}{M}, \frac{P_E}{M}, \frac{P_N}{M}, t \right),$$

where H is a homogeneous function of degree one in the ratios of prices to total expenditure-- $\frac{P_K}{M}$, $\frac{P_E}{M}$, and $\frac{P_N}{M}$. Under homogeneity the parameters of the direct translog utility function must satisfy the explicit homotheticity restrictions and the additional restriction:

$$\beta_{Mt} = 0 \quad .$$

We refer to this set of restrictions as the homogeneity restrictions. Under these restrictions only seven unknown parameters remain to be estimated.

A weaker form of homotheticity of preferences is groupwise homotheticity. An indirect utility function V with time-varying preferences that is groupwise homothetic in capital (K) and energy (E) can be written in the form:

$$\ln V = G \left[\ln H \left(\frac{P_K}{M}, \frac{P_E}{M}, \frac{P_N}{M}, t \right), \frac{P_N}{M}, t \right] ,$$

where H is homogeneous of degree one in the ratios of prices to total expenditure for capital and energy, $\frac{P_K}{M}$ and $\frac{P_E}{M}$. Under groupwise homotheticity in capital and energy the ratio of budget shares for capital and energy is homogeneous of degree zero in these ratios of prices to total expenditure. Under groupwise homotheticity the parameters of the indirect translog utility function satisfy the restrictions:

$$\beta_{KK} + \beta_{KE} = \sigma_{KE} \alpha_K ,$$

$$\beta_{KE} + \beta_{EE} = \sigma_{KE} \alpha_E .$$

This set of two restrictions involves the introduction of one new parameter, σ_{KE} , so that ten unknown parameters remain to be estimated. Corresponding to the three possible pairs of commodities, there are three possible sets of groupwise homotheticity restrictions. Restrictions analogous to those outlined above must hold for any one of the three possible types of groupwise homotheticity.

The translog approximation to a groupwise homothetic indirect utility function is not necessarily groupwise homothetic. We refer to an indirect translog utility function that is itself groupwise homothetic as intrinsically groupwise homothetic. If the parameters of the indirect translog utility function satisfy the groupwise homotheticity restrictions given above and the additional restriction:

$$\sigma_{KE} = 0 \quad ,$$

this function is groupwise homothetic in capital (K) and energy (E). We refer to these restrictions as the explicit groupwise homotheticity restrictions. Under these restrictions nine unknown parameters remain to be estimated. There are three possible sets of explicit groupwise homotheticity restrictions corresponding to the three possible pairs of commodities. Restrictions analogous to those outlined above must hold for any one of the three possible types of explicit groupwise homotheticity.

An indirect utility function with time-varying preferences that is inclusively groupwise homothetic in capital (K) and energy (E) can be written in the form:

$$\ln v = G \left[\ln \left(H \frac{P_K}{M}, \frac{P_E}{M}, \frac{P_N}{M}, t \right), t \right] \quad ,$$

where H is homogeneous of degree one in the ratios of prices to total expenditure for capital and energy-- $\frac{P_K}{M}$ and $\frac{P_E}{M}$. Given groupwise homotheticity, this condition implies in addition that the ratios of budget shares for capital and non-durables and for energy and non-durables are homogeneous of degree zero in these ratios of prices to total expenditure. Under inclusive

groupwise homotheticity in capital and energy the parameters of the indirect translog utility function satisfy the groupwise homotheticity restrictions given above and the additional restriction:

$$\beta_{KN} + \beta_{EN} = \sigma_{KE} \alpha_N .$$

Under this additional restriction, nine unknown parameters remain to be estimated. There are three possible sets of inclusive groupwise homotheticity restrictions, corresponding to the three possible sets of groupwise homotheticity restrictions. Analogous restrictions must hold for any one of the three possible types of inclusive groupwise homotheticity.

Finally, an indirect utility function with time-varying preferences is groupwise homogeneous if it can be written in the form:

$$\ln V = \ln H \left(\frac{P_K}{M}, \frac{P_E}{M}, \frac{P_H}{M}, t \right) ,$$

where H is homogeneous of degree one in the ratios of the prices of these commodities to total expenditure, $\frac{P_K}{M}$ and $\frac{P_E}{M}$, and we say that it is groupwise homogeneous in capital and energy. Under groupwise homogeneity the parameters of the indirect translog utility function must satisfy the explicit inclusive groupwise homotheticity restrictions given above and the additional restriction:

$$\beta_{Kt} + \beta_{Et} = 0 .$$

We refer to this set of restrictions as the groupwise homogeneity restrictions. Under these restrictions only seven unknown parameters remain to be estimated. There are three possible sets of groupwise homotheticity restrictions and analogous restrictions must hold for any one of them.

Finally, given groupwise separability and groupwise homotheticity in capital and energy, an indirect translog utility function is groupwise linear logarithmic if the ratio of the budget shares of capital and energy is independent of prices and total expenditure and depends only on time. Given groupwise separability and groupwise homotheticity in capital and energy, groupwise linear logarithmic utility in capital and energy requires the additional restrictions:

$$\beta_{KK}^{\alpha_E} = \beta_{KE}^{\alpha_K} \cdot$$

Under these restrictions only eight unknown parameters remain to be estimated. There are three possible sets of groupwise linear logarithmic utility restrictions and analogous restrictions must hold for any one of them.

To summarize: Starting with the assumption that our model for the allocation of personal consumption expenditures can be generated by utility maximization, we have developed tests of a series of possible restrictions on the underlying structure of consumer preferences. First, we have considered groupwise separability of preferences in commodities and in time. Second, we have considered overall homotheticity and groupwise homotheticity restrictions on preferences. Finally, we have considered groupwise linear logarithmic utility as a possible restriction on preferences.

4. Statistical Tests

Tests of the restrictions on preferences we have considered can be carried out in many sequences. We propose to test restrictions on the structure of preferences, given equality and symmetry restrictions, but not monotonicity and quasi-convexity restrictions. Monotonicity and quasi-convexity restrictions take

the form of inequalities rather than equalities, so that these restrictions do not affect the asymptotic distributions of our statistics for tests of restrictions on the structure of preferences.¹² These distributions are the same with or without imposing the restrictions associated with monotonicity and quasi-convexity. After the set of acceptable restrictions on the structure of preferences is determined, we can then impose the constraints implied by monotonicity and quasi-convexity of the indirect utility function.

Our proposed test procedure is presented in diagrammatic form in a series of four figures. We propose to test the restrictions derived from groupwise separability, homotheticity, and groupwise homotheticity in parallel. Given groupwise homothetic separability for any group, we proceed to test the additional restrictions implied by groupwise linear logarithmic utility, conditional on the restrictions implied by groupwise homothetic separability. Given the outcome of these tests we can determine the set of acceptable restrictions on the structure of preferences.

Beginning with separability, we observe that an indirect utility function V with time-varying preferences that is additive can be written in the form:

$$\ln V = G[\ln V^K(K,t) + \ln V^E(E,t) + \ln V^N(N,t),t] \quad .$$

Groupwise separability for two of the three possible groups of two commodities from the third commodity implies groupwise separability for the third group and additivity of the indirect utility function. The translog approximation to an additive indirect utility function is not necessarily additive. If the indirect translog utility function is additive, we say that it is explicitly additive. Explicit groupwise separability for two of the three possible groups implies explicit groupwise separability for the third and explicit additivity of the indirect utility function.

¹² See Malinvaud [12], pp. 366-368.

An indirect utility function V with time-varying preferences that is neutral can be written in the form:

$$\ln V = G[\ln V^1(K,E,N),t] \quad ,$$

where the function V^1 depends on the quantities consumed of the three commodities, but is independent of time. Groupwise separability for two of the three possible groups of two commodities from time implies groupwise separability of the third group from time and neutrality of the indirect utility function. The translog approximation to a neutral indirect utility function is not necessarily neutral. If the indirect translog utility function is neutral, we say that it is explicitly neutral. Explicit groupwise separability for two of the three possible groups from time implies explicit groupwise separability of the third group from time and explicit neutrality of the indirect utility function.

We first test groupwise separability restrictions for each possible group. If we accept groupwise separability for any group, we proceed to test explicit groupwise separability for that group. If we accept the hypothesis of groupwise separability from the third commodity for any two of the three possible groups, we accept the hypothesis of additivity. If we accept the hypothesis of explicit groupwise separability from the third commodity for any two of the three groups, we accept the hypothesis of explicit additivity. If we accept the hypothesis of groupwise separability from time for any two of the three possible groups, we accept the hypothesis of neutrality. If we accept the hypothesis of explicit groupwise separability from time for any two of the three groups, we accept the hypothesis of explicit neutrality.

Our test procedure for separability is presented diagrammatically in Figure 1. There are three tests of this type; the diagram gives only one set of such tests, corresponding to the group consisting of capital services (K) and energy (E). For each group we test groupwise separability from the third commodity, in this case non-durables (N), and from time. Conditional on the corresponding groupwise separability restrictions, we

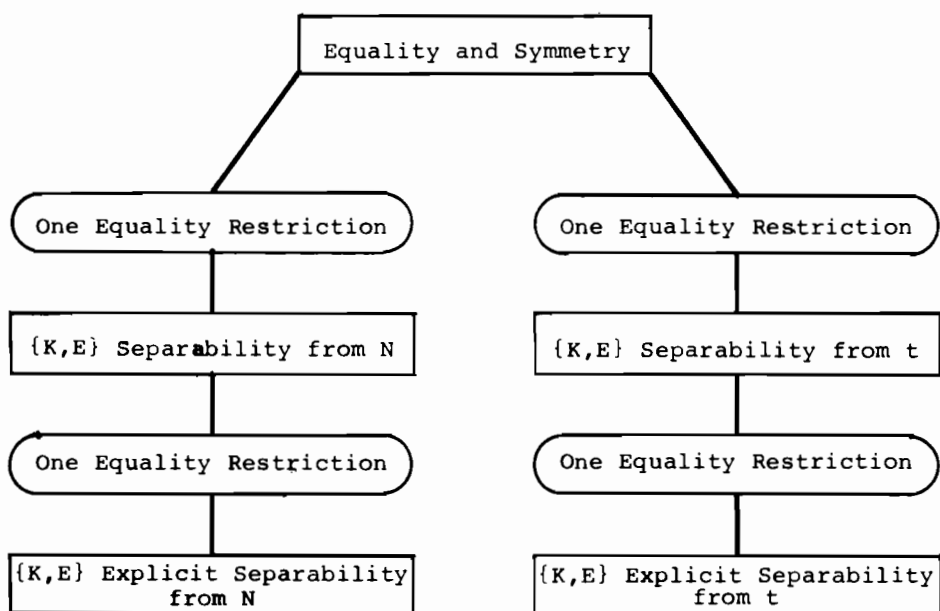

Figure 1. Tests of separability for the group $\{K,E\}$.

proceed to test the hypothesis of explicit groupwise separability from the third commodity and from time. Combining results from the tests for each of the three commodity groups, we can test the hypotheses of additivity, explicit additivity, neutrality, and explicit neutrality.

Continuing with homotheticity, we observe that an indirect utility function with time-varying preferences is characterized by linear logarithmic utility if it is groupwise linear logarithmic in all three possible groups consisting of two commodities each. Groupwise homogeneity for all three groups implies that the indirect utility function is linear logarithmic. We first test groupwise homotheticity restrictions for each possible group. In parallel we test homotheticity restrictions for the group consisting of all three commodities. If we accept groupwise homotheticity for any group, we proceed to test explicit groupwise homotheticity and inclusive groupwise homotheticity for that group. If we accept both explicit groupwise homotheticity and inclusive groupwise homotheticity for any group, we proceed to test groupwise homogeneity for that group. If we accept homotheticity for all three commodities, we proceed to test homogeneity. Finally, if we accept groupwise homogeneity for all three possible groups consisting of two commodities, we accept the hypothesis of linear logarithmic utility. Our test procedure for homotheticity and homogeneity is presented diagrammatically in Figures 2 and 3.

We can combine the results of our parallel tests of separability and homotheticity in order to draw conclusions about homothetic separability. If we accept the hypothesis of groupwise separability for a group consisting of two commodities, and for the same group we accept the hypotheses of groupwise homotheticity, explicit groupwise homotheticity, inclusive groupwise homotheticity, or groupwise homogeneity, we accept the hypotheses of groupwise homothetic separability, groupwise explicit homothetic separability, groupwise inclusive homothetic separability, or groupwise homogeneous separability, respectively, for that group. Similarly, if we accept the hypothesis of explicit groupwise separability for a given group, and one of the homotheticity hypotheses just listed, we accept the corresponding explicit

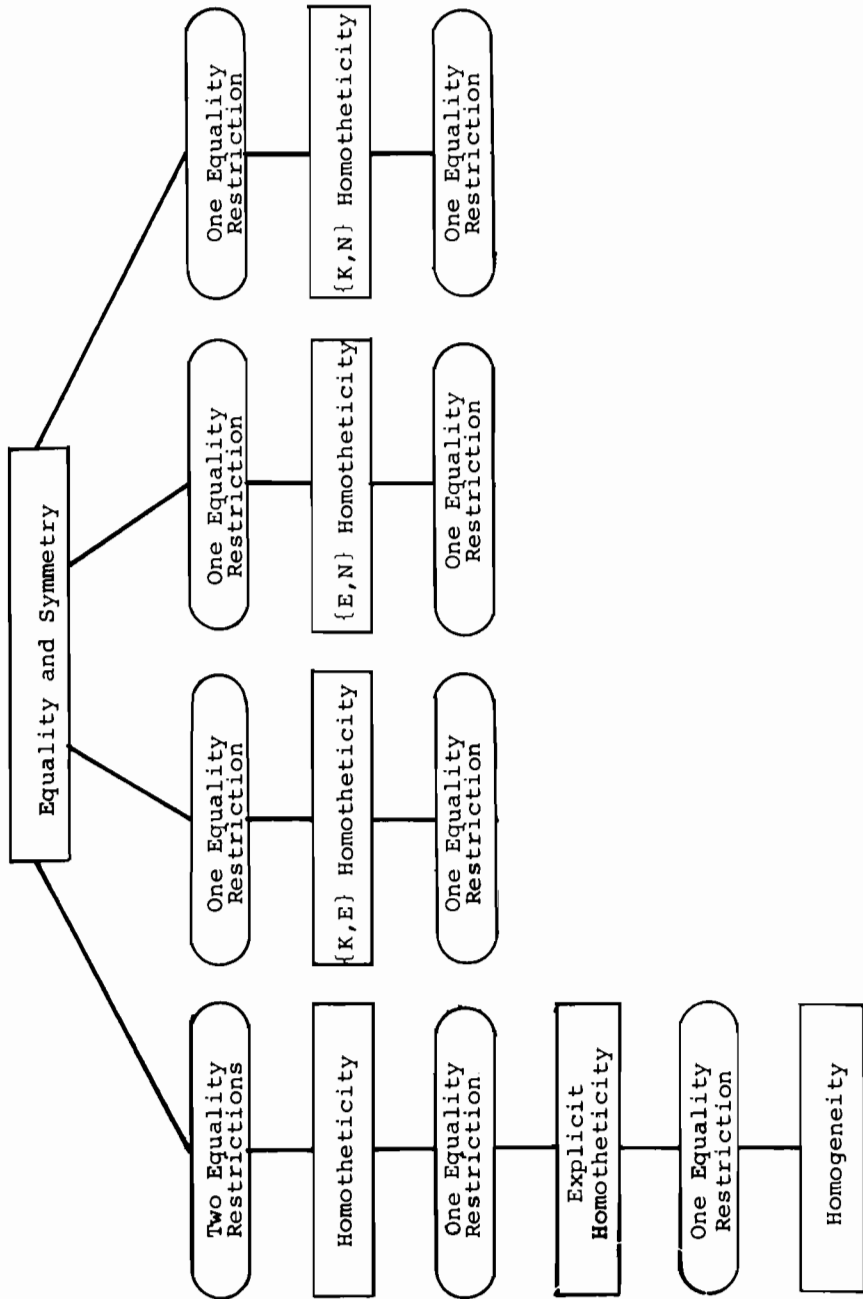

Figure 2. Tests of homotheticity .

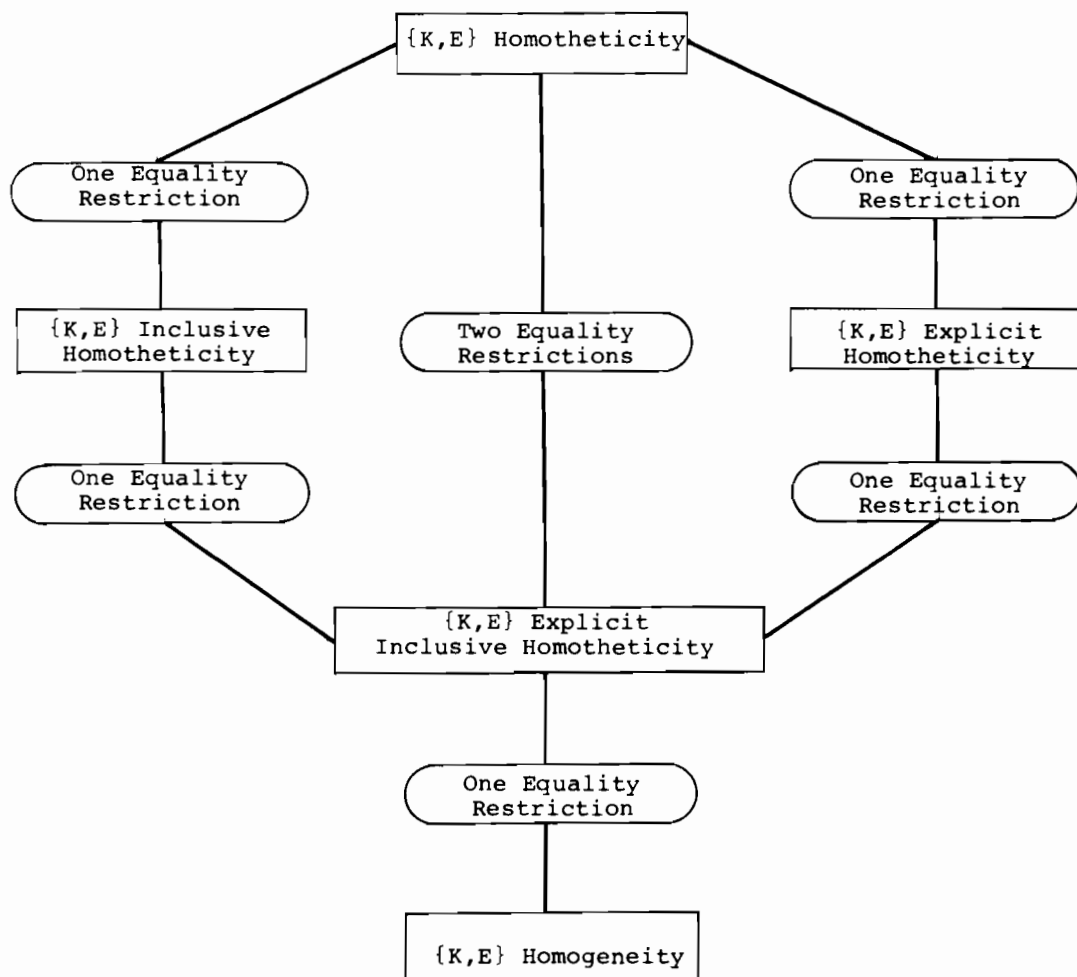

Figure 3. Tests of groupwise homotheticity for the group $\{K,E\}$.

groupwise homothetic separability hypothesis for that group. Explicit groupwise homogeneous separability is equivalent to groupwise linear logarithmic utility.

If we accept the hypotheses of groupwise homothetic separability for any group, we proceed to test the hypothesis of groupwise linear logarithmic utility for that group, conditional on homothetic separability. If we accept the hypothesis of groupwise homogeneous separability for any single group or pair of groups, but not for all three groups, we proceed to test the hypothesis of groupwise linear logarithmic utility for the corresponding groups, again proceeding conditionally on homothetic separability. If we accept the hypothesis of groupwise linear logarithmic utility for any two of the three groups, we accept the hypothesis of linear logarithmic utility. Similarly, if we accept the hypotheses of explicit separability and inclusive homotheticity for any two groups, not necessarily the same two groups for each of these hypotheses, we accept the hypothesis of linear logarithmic utility.

If we accept the hypotheses of additivity and homotheticity, we accept the hypothesis of homothetic additivity. If we accept the hypotheses of explicit additivity or homogeneity, or both, we accept the hypotheses of explicit additive homotheticity, additive homogeneity, or linear logarithmic utility, respectively. Our test procedures for groupwise linear logarithmic utility, given homothetic separability restrictions, are presented diagrammatically in Figure 4.

The first step in implementing an econometric model of demand based on the indirect translog utility function is to add a stochastic specification to the theoretical model based on equations for the three budget shares. Given the disturbances for any two equations, the disturbance for the remaining equation can be determined from the budget constraint. Only two of the equations are required for a complete model of consumer demand. We estimate two equations for the budget shares, subject to normalization of the parameter α_M appearing in each equation at unity.¹³

¹³We employ the maximum likelihood estimator discussed, for example, by Malinvaud [12], pp. 338-341.

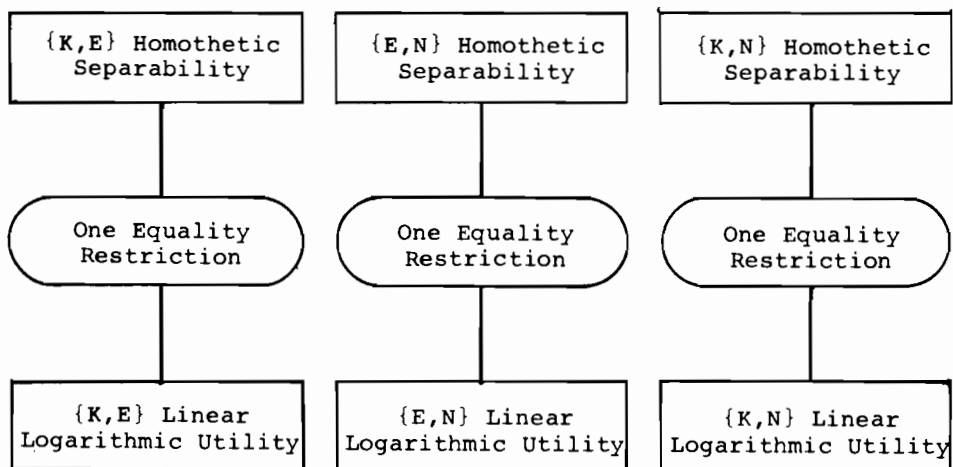

Figure 4. Tests of linear logarithmic utility.

Our empirical results are based on time series data for prices and quantities of capital services (K), energy (E) and non-durables (N).¹⁴ We have fitted the equations for budget shares of capital and non-durables. We impose the hypothesis that the model of demand is consistent with utility maximization, so that the parameters of this model satisfy equality and symmetry restrictions. Given these restrictions, eleven unknown parameters remain to be estimated in our econometric model.

Given the validity of the theory of demand, we proceed to test hypotheses about possible restrictions on the structure of preferences of capital, energy, and non-durables. First, we test hypotheses associated with groupwise separability. Our second set of restrictions on the structure of preferences is associated with homotheticity--groupwise homotheticity, explicit groupwise homotheticity, inclusive groupwise homotheticity, groupwise homogeneity, homotheticity and homogeneity. Combining separability and homotheticity restrictions, we obtain estimates under groupwise homothetic separability. We also test the additional restriction of groupwise linear logarithmic utility.

To test the validity of restrictions on the structure of preferences, we employ test statistics based on the likelihood ratio λ , where:

$$\lambda = \frac{\max_{\omega} \mathcal{L}}{\max_{\Omega} \mathcal{L}} .$$

The likelihood ratio is the ratio of the maximum value of the likelihood function \mathcal{L} for the econometric model of demand Ω without restriction to the maximum value of the likelihood function for the model ω subject to restriction.

We have estimated our econometric model of demand for energy from data on US personal consumption expenditures for the period 1947-1971. There are twenty-five observations for each behavioral equation, so that the number of degrees of freedom available for tests of hypotheses about the structure of preferences is fifty. For normally distributed disturbances

¹⁴These data are based on estimates by Faucett Associates [6].

the likelihood ratio is equal to the ratio of the determinant of the restricted estimator of the variance-covariance matrix of the disturbances to the determinant of the unrestricted estimator, each raised to the power $-(n/2)$.

Our test statistic for each set of restrictions is based on minus twice the logarithm of the likelihood ratio, or:

$$-2 \ln \lambda = n(\ln |\hat{\Sigma}_\omega| - \ln |\hat{\Sigma}_\Omega|) ,$$

where $\hat{\Sigma}_\omega$ is the restricted estimator of the variance-covariance matrix and $\hat{\Sigma}_\Omega$ is the unrestricted estimator. Under the null hypothesis the likelihood ratio test statistic is distributed, asymptotically, as chi-squared with a number of degrees of freedom equal to the number of restrictions to be tested. We employ the asymptotic distribution of the likelihood ratio test statistic for tests of hypotheses.

To control the overall level of significance for our series of tests, we set the level of significance at .05. We then allocate the overall level of significance among the various stages of each series of tests. We test groupwise separability, homotheticity, and groupwise homotheticity proceeding conditionally on the validity of the equality and symmetry restrictions implied by the theory of demand. These tests are not "nested" so that the sum of the levels of significance for each of the four sets of hypotheses is an upper bound for the level of significance of tests of the sets of hypotheses considered simultaneously.

Within each of the sets of restrictions we allocate the overall level of significance among the various sub-sets of restrictions. Not all of these tests are "nested" so that we use the sum of the levels of significance for all tests corresponding to a given set of restrictions as an upper bound for the level of significance for the sub-sets of restrictions considered simultaneously. Finally, we test groupwise linear logarithmic utility, conditional on the restrictions implied by homothetic separability. Again, we use the sum of levels of

significance as an upper bound for the level of significance of the tests considered simultaneously.

We assign a level of significance of .01 to each of five sets of restrictions--groupwise separability from commodities, groupwise separability from time, homotheticity, groupwise homotheticity, and groupwise linear logarithmic utility. There are six restrictions associated with groupwise separability and explicit groupwise separability from commodities; we assign the level of significance .0017 to each. We assign the same level of significance to restrictions associated with separability from time. There are three sets of restrictions associated with homotheticity. We assign .0033 to each. There are twelve restrictions associated with groupwise homotheticity. We assign the level of significance .0083 to each. Finally, there are three restrictions associated with groupwise linear logarithmic utility. We assign .0033 to each of these restrictions.

For our econometric model of demand based in the indirect translog utility function with time-varying preferences we have assigned levels of significance to each of our tests of hypotheses about the structure of preferences so as to control the overall level of significance for all tests at .05. The probability of a false rejection for one test among the collection of all tests we consider is less than or equal to .05. With the aid of critical values for our test statistics given in Table 1, the reader can evaluate the results of our tests for alternative significance levels or for alternative allocations of the overall level of significance among stages of our test procedure. Test statistics for each of the hypotheses we have considered about the structure of preferences are given in Table 2.

The results of our tests of restrictions on preferences, as presented in Table 2, are that the group consisting of capital (K) and non-durables (N) is explicitly separable from energy (E) and from time (t). This group is also explicitly

Table 1. Critical values of χ^2 /degrees of freedom.

| Degrees of freedom | Level of Significance | | | | | |
|-----------------------|-----------------------|------|------|------|-------|-------|
| | .10 | .05 | .01 | .005 | .001 | .0005 |
| 1 | 2.71 | 3.84 | 6.64 | 7.88 | 10.83 | 12.12 |
| 2 | 2.30 | 3.00 | 4.61 | 5.30 | 6.91 | 7.60 |

groupwise homothetic. Further simplifications of this specification are rejected. Employing the restrictions corresponding to explicit groupwise homothetic separability and to explicit separability from time, we can reduce the number of parameters to be estimated from eleven to five. Under these restrictions the estimated form of our econometric model of consumer demand

Table 2. Test statistics.

| Hypothesis | Degrees of Freedom | Test Statistic |
|-------------------------------------|--------------------|----------------|
| <u>Given Equality and Symmetry</u> | | |
| Groupwise separability | | |
| {K,E} from N | 1 | 15.14 |
| {K,N} from E | 1 | 0.55 |
| {E,N} from K | 1 | 30.35 |
| {K,E} from t | 1 | 27.96 |
| {K,N} from t | 1 | 3.83 |
| {E,N} from t | 1 | 37.73 |
| Homotheticity | 2 | 25.37 |
| Groupwise homotheticity | | |
| {K,E} | 1 | 24.68 |
| {K,N} | 1 | 1.08 |
| {E,N} | 1 | 17.65 |
| <u>Given Groupwise Separability</u> | | |
| Groupwise explicit separability | | |
| {K,E} from N | 1 | 0.38 |
| {K,N} from E | 1 | 1.39 |
| {E,N} from K | 1 | 5.27 |
| {K,E} from t | 1 | 0.67 |
| {K,N} from t | 1 | 3.99 |
| {E,N} from t | 1 | 15.17 |
| <u>Given Homotheticity</u> | | |
| Explicit homotheticity | 1 | 1.20 |

Table 2. (concluded)

| Hypothesis | Degree of Freedom | Test Statistic |
|---|-------------------|----------------|
| <u>Given Groupwise Homotheticity</u> | | |
| Groupwise inclusive homotheticity | | |
| {K,E} | 1 | 21.99 |
| {K,N} | 1 | 13.04 |
| {E,N} | 1 | 13.11 |
| Groupwise explicit homotheticity | | |
| {K,E} | 1 | 0.16 |
| {K,N} | 1 | 1.63 |
| {E,N} | 1 | 13.99 |
| <u>Given Explicit Homotheticity</u> | | |
| Homogeneity | 1 | 45.50 |
| <u>Given Groupwise Explicit Inclusive Homotheticity</u> | | |
| Groupwise homogeneity | | |
| {K,E} | 1 | 13.12 |
| {K,N} | 1 | 38.89 |
| {E,N} | 1 | 52.24 |
| <u>Given Groupwise Homothetic Separability</u> | | |
| Groupwise linear logarithmic utility | | |
| {K,E} | 1 | 20.49 |
| {K,N} | 1 | 27.06 |
| {E,N} | 1 | 10.35 |

for energy is as follows:

$$\frac{P_K^K}{M} = \frac{-.229 - .132 (1n \frac{P_K}{M} - 1n \frac{P_N}{M})}{(.005) \quad (.010)} ,$$

$$-1 - .0307 \quad 1n \frac{P_E}{M} - .00094 \cdot t$$

$$(.0024) \quad (.00010)$$

$$\frac{P_E^E}{M} = \frac{-.0503 - .0307 \quad 1n \frac{P_E}{M} - .00094 \cdot t}{(.0007) \quad (.0024) \quad (.00010)} ,$$

$$-1 - .0307 \quad 1n \frac{P_E}{M} - .00094 \cdot t$$

$$(.0024) \quad (.00010)$$

$$\frac{P_N^N}{M} = \frac{-.721 + .132 (1n \frac{P_K}{M} - 1n \frac{P_N}{M})}{(.006) \quad (.010)} .$$

$$-1 - .0307 \quad 1n \frac{P_E}{M} - .00094 \cdot t$$

$$(.0024) \quad (.00010)$$

Estimates of the parameters of this model obtained without any further restriction satisfy the monotonicity and quasi-convexity restrictions, so that estimation subject to the inequalities that embody these restrictions is unnecessary (see footnote ten).

5. Applications

For applications of our econometric model of consumer demand for energy to quantitative assessment of alternative energy policies, we require estimates of price and income elasticities of demand for energy and non-energy products and cross-price elasticities of demand among capital (K), energy (E), and non-durables (N)--the three commodity groups included in our model. For any set of prices, any level of personal consumption expenditures, and any point in time, we calculate price and income elasticities from our econometric model of consumer demand for energy. For example, the price elasticity of demand

for energy, say η_{EE} , is:

$$\eta_{EE} = \frac{.0307}{-1 - .0307 \ln \frac{P_E}{M} - .00094 \cdot t} - \frac{.0307}{-.0503 - .0307 \ln \frac{P_E}{M} - .00094 \cdot t} - 1 .$$

Similarly, the income elasticity of demand for energy, say η_{EM} , is:

$$\eta_{EM} = \frac{.0307}{-.0503 - .0307 \ln \frac{P_E}{M} - .00094 \cdot t} - \frac{.0307}{-1 - .0307 \ln \frac{P_E}{M} - .00094 \cdot t} + 1 .$$

A complete set of own-price and income elasticities of demand for the three commodity groups included in our model is given in Table 3. A complete set of cross-price elasticities of demand for these three groups is also given in Table 3. All price elasticities of demand are computed with income held constant. The total effect of a change in price on demand includes both income and substitution effects. Under explicit groupwise homothetic separability of the group consisting of capital services and non-durables {K,N} from energy (E), the cross-price elasticities of demand for capital services and non-durables with respect to energy are identical.

The income elasticity of demand for energy is considerably below unity throughout the period 1947-1971. The own-price elasticity of demand for energy is negative and substantial in magnitude and demand for energy remains inelastic with respect

Table 3. Income and price elasticities of demand.

| Year | η_{KM} | η_{EM} | η_{NM} | η_{KK} | η_{EE} | η_{NN} | η_{KE} | η_{KN} | η_{EK} | η_{EN} | η_{NK} | η_{NE} |
|------|-------------|-------------|-------------|-------------|-------------|-------------|-------------|-------------|-------------|-------------|-------------|-------------|
| 1947 | 1.03 | .39 | 1.03 | -.45 | -.39 | -.82 | -.03 | -.55 | 0 | 0 | -.18 | -.03 |
| 1948 | 1.03 | .44 | 1.03 | -.41 | -.44 | -.82 | -.03 | -.59 | 0 | 0 | -.18 | -.03 |
| 1949 | 1.03 | .45 | 1.03 | -.35 | -.45 | -.82 | -.03 | -.65 | 0 | 0 | -.18 | -.03 |
| 1950 | 1.03 | .44 | 1.03 | -.44 | -.44 | -.82 | -.03 | -.56 | 0 | 0 | -.18 | -.03 |
| 1951 | 1.03 | .43 | 1.03 | -.41 | -.43 | -.82 | -.03 | -.59 | 0 | 0 | -.18 | -.03 |
| 1952 | 1.03 | .42 | 1.03 | -.41 | -.42 | -.82 | -.03 | -.59 | 0 | 0 | -.18 | -.03 |
| 1953 | 1.03 | .43 | 1.03 | -.43 | -.43 | -.82 | -.03 | -.57 | 0 | 0 | -.18 | -.03 |
| 1954 | 1.03 | .43 | 1.03 | -.43 | -.43 | -.82 | -.03 | -.57 | 0 | 0 | -.18 | -.03 |
| 1955 | 1.03 | .42 | 1.03 | -.45 | -.42 | -.81 | -.03 | -.55 | 0 | 0 | -.19 | -.03 |
| 1956 | 1.03 | .43 | 1.03 | -.44 | -.43 | -.82 | -.03 | -.56 | 0 | 0 | -.18 | -.03 |
| 1957 | 1.03 | .43 | 1.03 | -.43 | -.43 | -.82 | -.03 | -.57 | 0 | 0 | -.18 | -.03 |
| 1958 | 1.03 | .42 | 1.03 | -.42 | -.42 | -.82 | -.03 | -.58 | 0 | 0 | -.18 | -.03 |
| 1959 | 1.03 | .41 | 1.03 | -.45 | -.41 | -.82 | -.03 | -.55 | 0 | 0 | -.18 | -.03 |
| 1960 | 1.03 | .40 | 1.03 | -.45 | -.40 | -.81 | -.03 | -.55 | 0 | 0 | -.19 | -.03 |
| 1961 | 1.03 | .42 | 1.03 | -.45 | -.42 | -.82 | -.03 | -.55 | 0 | 0 | -.18 | -.03 |
| 1962 | 1.03 | .41 | 1.03 | -.46 | -.41 | -.81 | -.03 | -.54 | 0 | 0 | -.19 | -.03 |
| 1963 | 1.03 | .40 | 1.03 | -.46 | -.40 | -.81 | -.03 | -.54 | 0 | 0 | -.19 | -.03 |
| 1964 | 1.03 | .38 | 1.03 | -.47 | -.38 | -.81 | -.03 | -.53 | 0 | 0 | -.19 | -.03 |
| 1965 | 1.03 | .38 | 1.03 | -.47 | -.38 | -.81 | -.03 | -.53 | 0 | 0 | -.19 | -.03 |
| 1966 | 1.03 | .37 | 1.03 | -.48 | -.37 | -.81 | -.03 | -.52 | 0 | 0 | -.19 | -.03 |
| 1967 | 1.03 | .36 | 1.03 | -.47 | -.36 | -.81 | -.03 | -.53 | 0 | 0 | -.19 | -.03 |
| 1968 | 1.03 | .34 | 1.03 | -.45 | -.34 | -.81 | -.03 | -.55 | 0 | 0 | -.19 | -.03 |
| 1969 | 1.03 | .32 | 1.03 | -.46 | -.32 | -.81 | -.03 | -.54 | 0 | 0 | -.19 | -.03 |
| 1970 | 1.03 | .31 | 1.03 | -.44 | -.31 | -.82 | -.03 | -.56 | 0 | 0 | -.18 | -.03 |
| 1971 | 1.03 | .31 | 1.03 | -.45 | -.31 | -.81 | -.03 | -.55 | 0 | 0 | -.19 | -.03 |

to price throughout the period. The income elasticity of demand for capital services is positive and greater than unity throughout the period; similarly, the income elasticity of demand for non-durables is positive and greater than unity. Demand for capital services and for non-durables are both price inelastic throughout the period.

The cross-price elasticities of demand for energy with respect to the prices of capital services and non-durables are zero throughout the period, 1947-1971. By contrast the cross-price elasticities of demand for capital services and non-durables with respect to energy, which are identical, are small and negative. Our statistical tests have resulted in a specification of our model of consumer demand for which a change in the price of energy relative to non-energy products leaves the allocation of the non-energy portion of the consumer budget between capital services and non-durables unchanged. Finally, the cross-price elasticities of demand for capital services with respect to non-durables and non-durables with respect to capital services are negative throughout the period.

Historically, the price of energy has dropped very substantially relative to the prices of capital services and non-durables over the period, 1947-1971. The share of energy in personal consumption expenditures has remained fairly stable, while the share of capital services has risen relative to non-durables with most of the change occurring in the first half of the period, 1947-1971. The negative impact of growth in income on the share for energy in personal consumption expenditures has been more than offset by the substantial positive impact of reduction in energy prices, leaving the share of energy essentially unchanged. A rise in energy prices relative to non-energy prices can be expected to increase the energy share of total expenditure.

In conclusion, our results lend support to the view that increases in the price of energy can induce energy conservation

by consumers. An increase in the price of energy resulting, for example, from an excise tax on energy, would induce energy conservation, and would leave the share of the non-energy budget allocated to capital services unchanged. A somewhat surprising feature of our results is that growth in income has a negative impact on the share of energy in personal consumption expenditures and that the stability of the energy share of the consumer budget during the period 1947-1971 is due to the positive effect of a declining price of energy relative to non-energy products offsetting the negative effect of income growth.

References

- [1] Christensen, L. R., and Jorgenson, D. W. "The Measurement of U.S. Real Capital Input, 1929-1967." Review of Income and Wealth, 15, 4 (December 1969), 293-320.
- [2] Christensen, L. R., and Jorgenson, D. W. "U.S. Income Saving and Wealth, 1929-1969." Review of Income and Wealth, 19, 4 (December 1973), 329-362.
- [3] Christensen, L. R., Jorgenson, D. W., and Lau, L. J. "Transcendental Logarithmic Utility Functions." American Economic Review, 65, 3 (June 1975), 367-383.
- [4] Christensen, L. R., and Manser, M. "Estimating U.S. Consumer Preferences for Meat. 1947-1971." Workshop Series 7403. Madison, Wisconsin, Social Systems Research Institute, University of Wisconsin, February 1974.
- [5] Diewert, E. "Homogeneous Weak Separability and Exact Index Numbers." Vancouver, Department of Economics, University of British Columbia, 1974.
- [6] Faucett, J. et al. Data Development for the I-O Energy Model. Chevy Chase, Jack Faucett Associates, 1973.
- [7] Jorgenson, D. W. Energy Resources and Economic Growth, Forthcoming 1975.
- [8] Jorgenson, D. W., and Lau, L. J. "The Structure of Consumer Preferences." Annals of Social and Economic Measurement, 4, 1 (January 1975), 49-101.
- [9] Lau, L. J. "Duality and the Structure of Utility Functions." Journal of Economic Theory, 1, 4 (December 1969), 374-396.
- [10] Lau, L. J. "Econometrics of Monotonicity, Convexity, and Quasi-Convexity." Technical Report No. 123. Palo Alto, Institute for Mathematical Studies in the Social Sciences, Stanford University, March 1974.
- [11] Lau, L. J., and Mitchell, B. M. "A Linear Logarithmic Expenditure System: An Application to U.S. Data." Econometrica, 39, 4 (July 1971), 87-88.

- [12] Malinvaud, E. Statistical Methods of Econometrics. Second edition. Amsterdam, North-Holland, 1970.
- [13] Roy, R. De l'Utilité: Contribution à la Théorie des Choix. Paris, Hermann, 1943.
- [14] Simon, N. "Personal Consumption Expenditures in the 1963 Input-Output Study." Survey of Current Business, 51, 1 (January 1971), 34-38.
- [15] Taylor, L. "The Demand for Electricity: A Survey." Bell Journal of Economics, 6, 2 (forthcoming Autumn 1975).

Primary Energy Substitution Models: On the Interaction
between Energy and Society¹

C. Marchetti

Introduction

This paper describes an attempt to develop a "synthetic" model of primary energy substitution, using certain rules which proved fruitful in describing the substitution of other commodities. This model will be used for forecasting, and for checking the validity of certain objectives set for research and development in the field of energy.

Trends in Energy Demand

The first point in forecasting energy demand is obviously to look at historical trends, over a century at least, and try to extract the signal out of the white noise and various medium-scale perturbations that occur along the way. Although the long-term extrapolation of these trends may require a more subtle analysis of social and economic trends, they are good to be kept in mind.

The ones reported in Figures 1 and 2 have something special. They include wood and farm waste. This is necessary to get a proper basis for extrapolation because part of the growth of commercial energy sources is due to the use of wood and farm waste.

As you see, apart from some "overheating" coinciding with World War I and preceding the 1930's recession, and the big dip

¹This paper is from a lecture delivered in Moscow in November 1974.

WORLD ENERGY CONSUMPTION

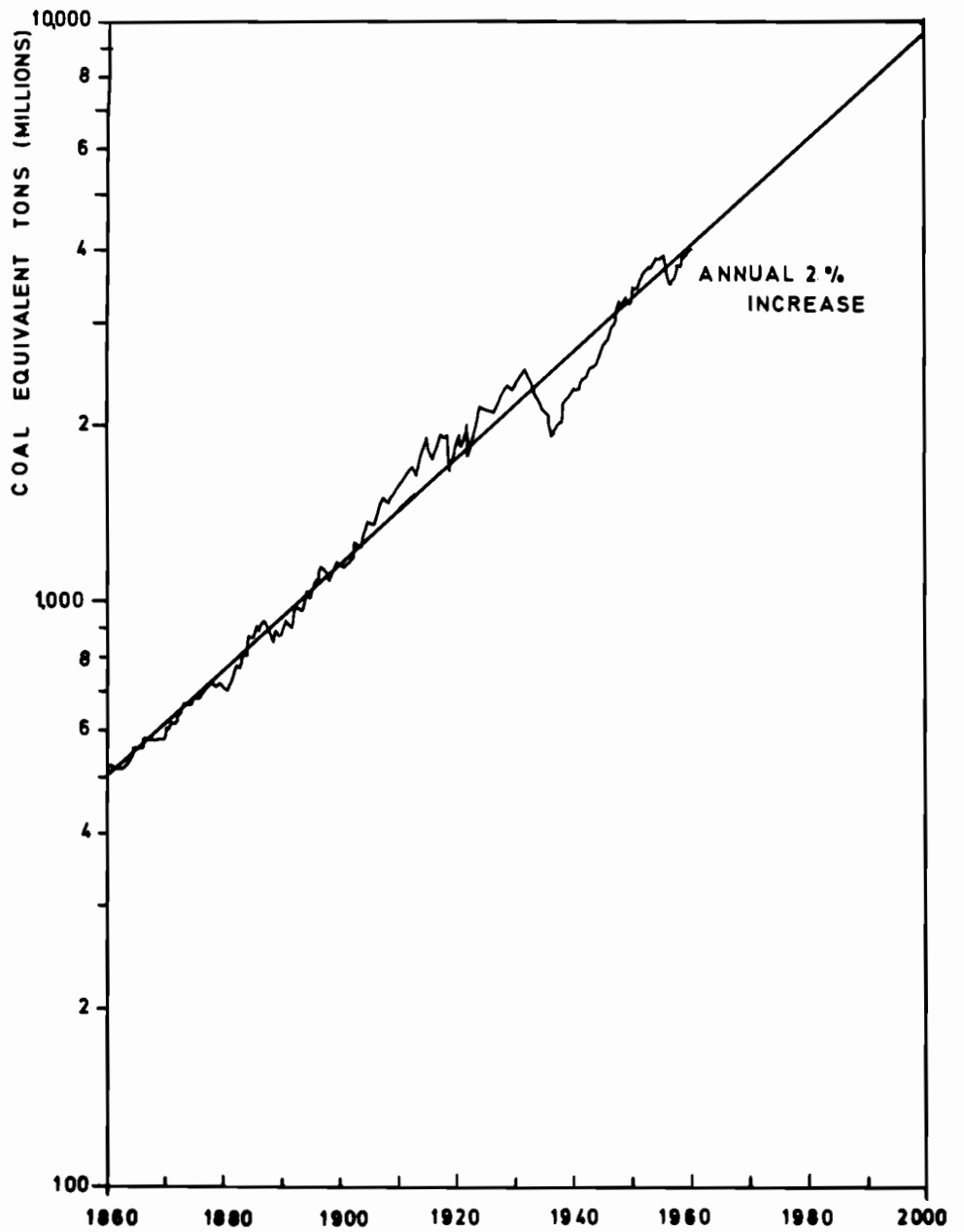
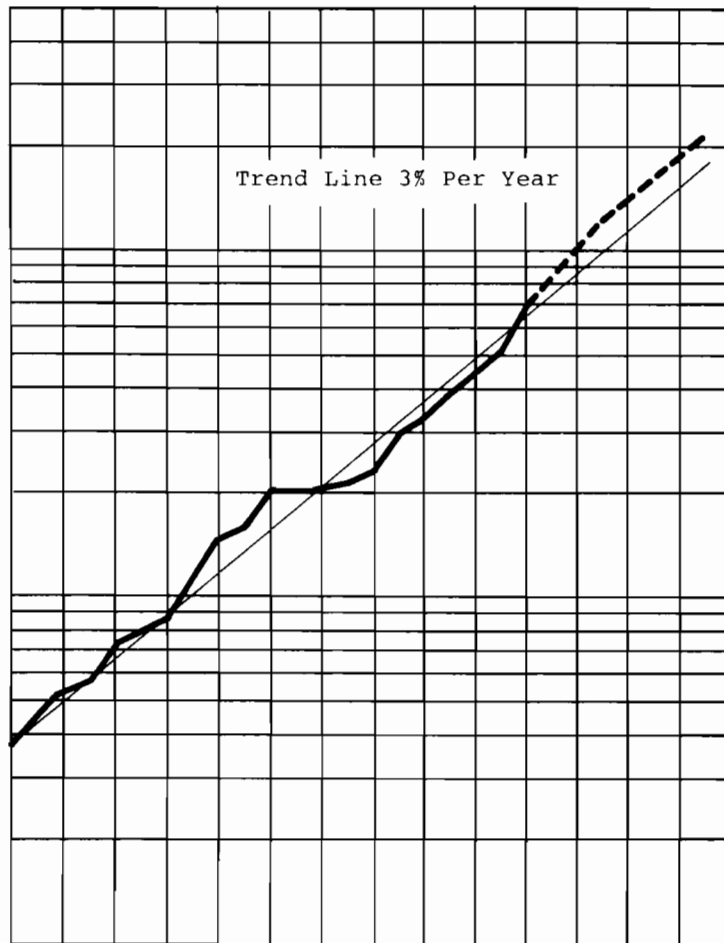

Figure 1. World energy consumption, including wood and farm waste. The trend line has a 2% slope.



Note: Adapted from Lapp [2].

Figure 2. Total US energy consumption.

coinciding with the Great Depression, "healed" then by World War II, the 2% secular trend is followed quite tightly for the world, even taking into account the compression due to the log display.

In the case of the US we also have a well-defined trend with the bumps in somehow different positions. The higher value of 3% does not appear particularly significant as the US population has grown roughly 1% faster than the rest of the world in the period considered (1860-1960).

The second point is to look inside the envelope of total energy demand for trends in primary fuels demand. I did this exercise at IIASA, using a methodology completely different from the "modelling" which is so popular in many places of the world, and whose contradictory results, when used to forecast over long ranges, cast many doubts on its reliability.

I started from the somehow iconoclastic hypothesis that the different primary energy sources are commodities competing for a market, like different brands of soap or different processes to make steel, so that the rules of the game may after all be the same. These rules are best described by Fischer and Pry [1] and Pry [4], and can be resumed in saying that the fractional rate at which a new commodity penetrates a market is proportional to the fraction of the market not yet covered:

$$\frac{1}{F} \cdot \frac{dF}{dt} = \alpha(1-F) \quad , \quad (1)$$

or

$$\ln (F/1-F) = \alpha t + C \quad (2)$$

where

F = fraction of market penetrated;
 α and C = constants, characteristic of the
particular commodity and market.

In Figures 3, 4 and 5 some cases of market penetration are reported, showing the extraordinary precision by which those curves fit the statistical data (which often are not very precise). All of them refer to a competition between two products. In the case of energy we have three or four energy sources competing most of the time so I had to extend the treatment a little with the extra rule that one of the fractions is defined as the difference to one of the sum of the others. This fraction follows approximately an equation of type (2) most of the time, but not always. It finally shows saturation and change in coefficients.

The fraction dealt with in this way corresponds to the oldest of the growing ones. The rule can be expressed in the form: first in--first out. Figure 6 shows the plotting of statistical data for the US in the form $\ln(F/1 - F)$ versus time.

More than a century of data can be fitted in an almost perfect way using only two constants, which come out to be two dates, for each of the primary energy sources (wood, coal, oil, gas). The whole destiny of an energy source seems to be completely predetermined in the first childhood.

As we can see by analyzing the curves and the statistical data in greater detail, these trends--if we can call them that--go unscathed through wars, wild oscillations in energy prices and depressions. Final total availability of the primary reserves also seems to have no effect on the rate of substitution. The only real departures from the curves are due to strikes in the coal industry, but the previous trend is rapidly resumed and the effects of the strike somehow "healed."

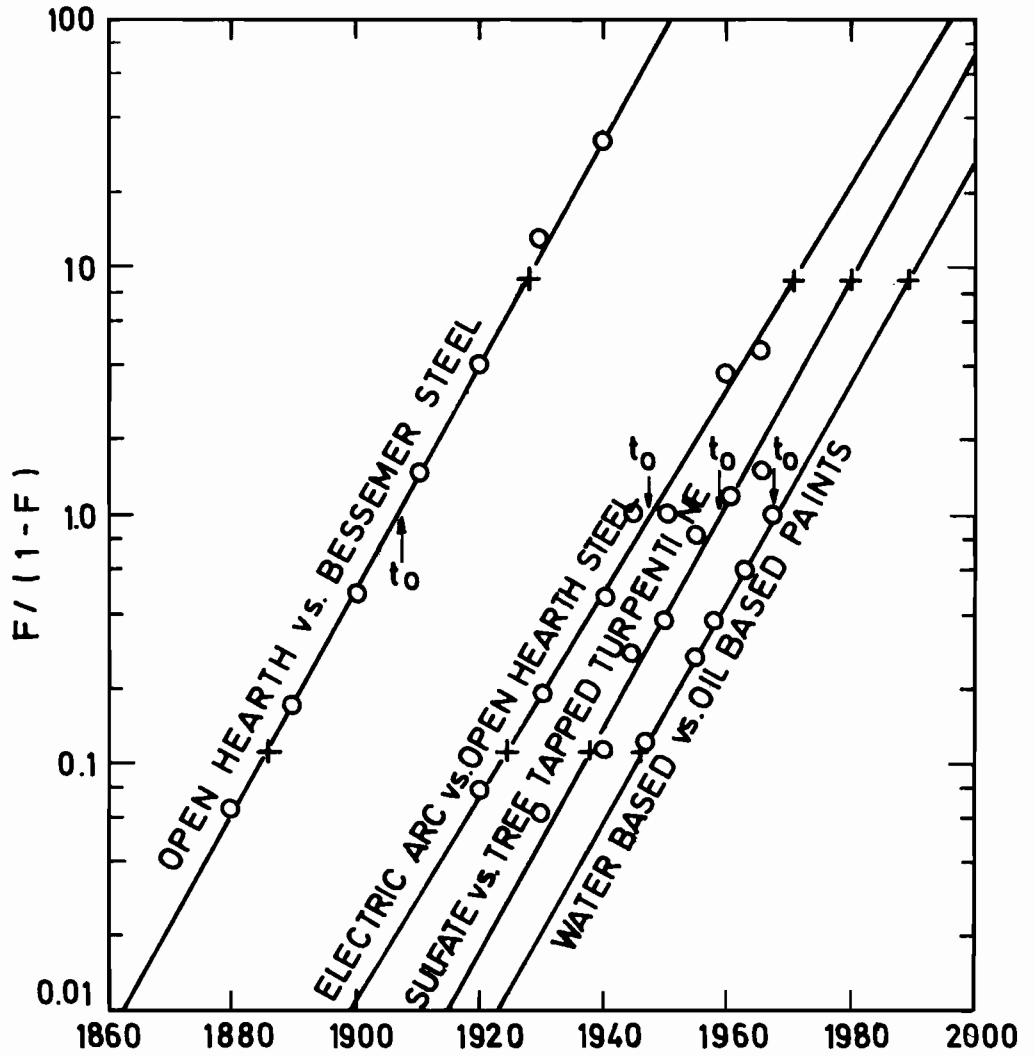

Figure 3. Market penetration curves in the US for:

- 1) open-hearth versus Bessemer steel;
- 2) electric arc versus open hearth steel;
- 3) sulphate turpentine versus natural turpentine;
- 4) water based versus oil based paints.

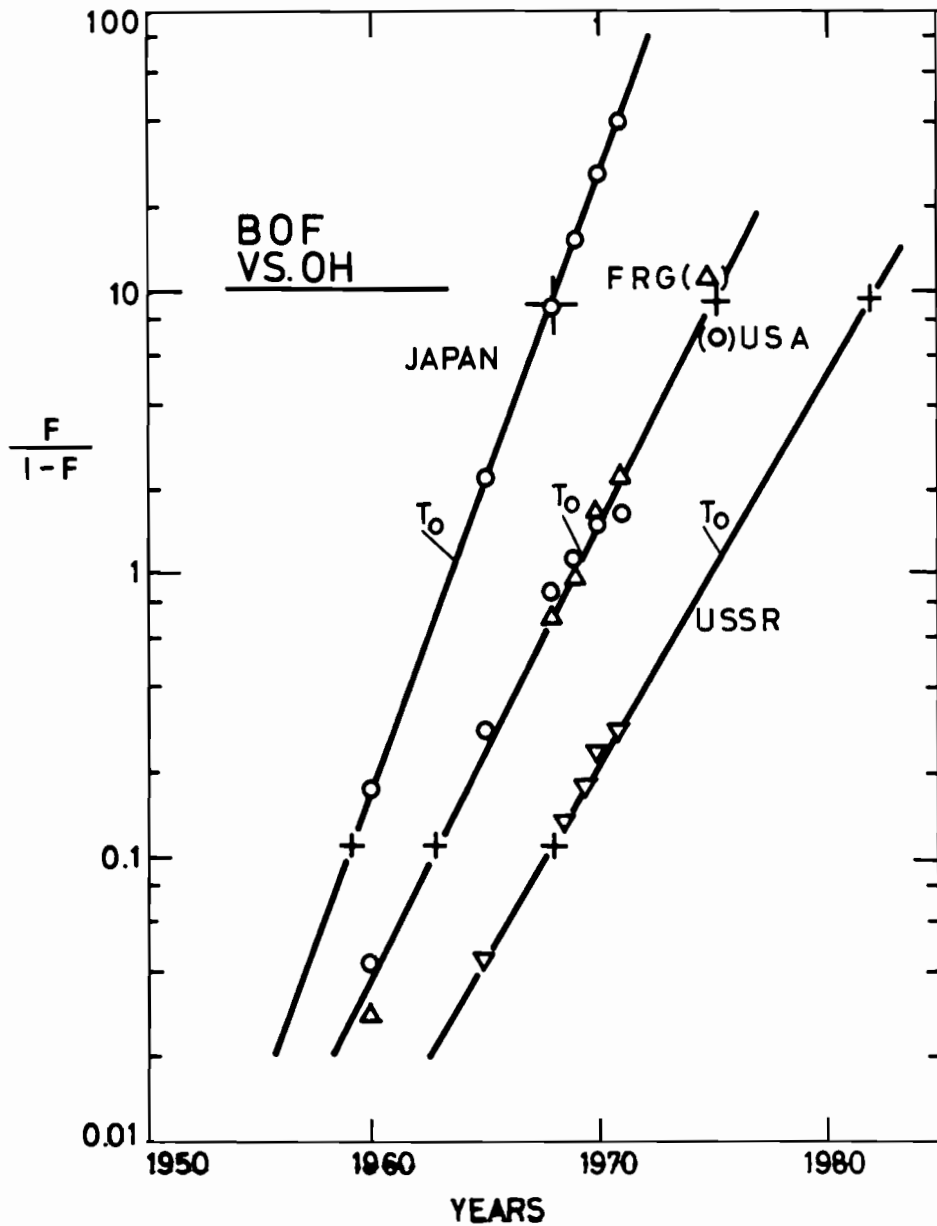

Figure 4. Market penetration curves for oxygen steel (BOF) versus open hearth and Bessemer steel in four countries (Japan, the US, the FRG, the USSR). The same law appears to hold also for a socialist economy. Japan appears to be the first to intensively use this technique, originally developed in Austria during World War II.

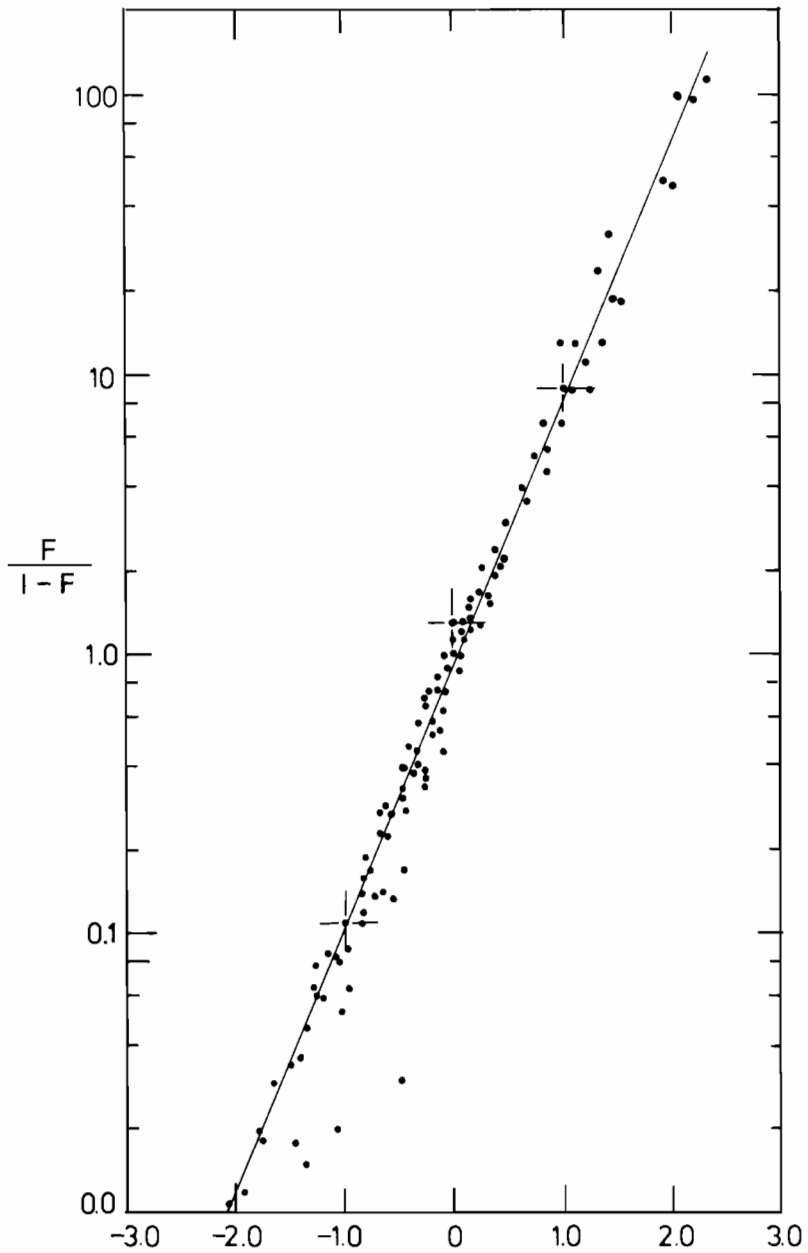

Figure 5. Normalized plotting for seventeen cases of market penetration. This shows that in spite of a certain amount of noise the trends are respected even over very long periods of time.

On the point of availability it seems that the market regularly moved away from a certain primary energy source, long before it was exhausted, at least at world level. The extrapolation of these trends indicates that the same thing is likely to happen in the future, e.g. that oil reserves will never be exhausted because of the timely introduction of other energy sources.

When I started displaying these curves, people said they were fascinated, then that the fit was too good to be true, then that one should find the explanation before accepting and using them. I have nothing to say about the first two points, but the third one is unacceptable in principle: laws work or do not work, and the only reason to accept a rule as a law is that all sorts of tests applied to it show that it works.

What most model makers do, starting from elementary relations and by functional and progressive aggregations going to macroscopic variables (e.g. demand), is very similar to what is done in statistical mechanics in order to "induce" for instance thermodynamic laws from mechanistic principles. But thermodynamics is completely autonomous from the interpretation, in the sense that its "truth" is internal to the set of macroscopic measurements from which it has been derived.

Now, putting philosophy aside, I played the game of forecasting (i.e. of backcasting) within the historical period. For example, I took the data for the US from 1930 to 1935 and tried to forecast oil coverage of the US up to 1970. As Figure 7 shows, the predicted values even for the saturation period fit the statistical data better than 1%, which after all is the minimum error that can be expected from these kinds of statistics. This means that the contribution of oil to the US energy budget, for example in 1965, was completely

US - OIL ENERGY FRACTION CALCULATED
FROM 1930 - 1940 TREND LINES

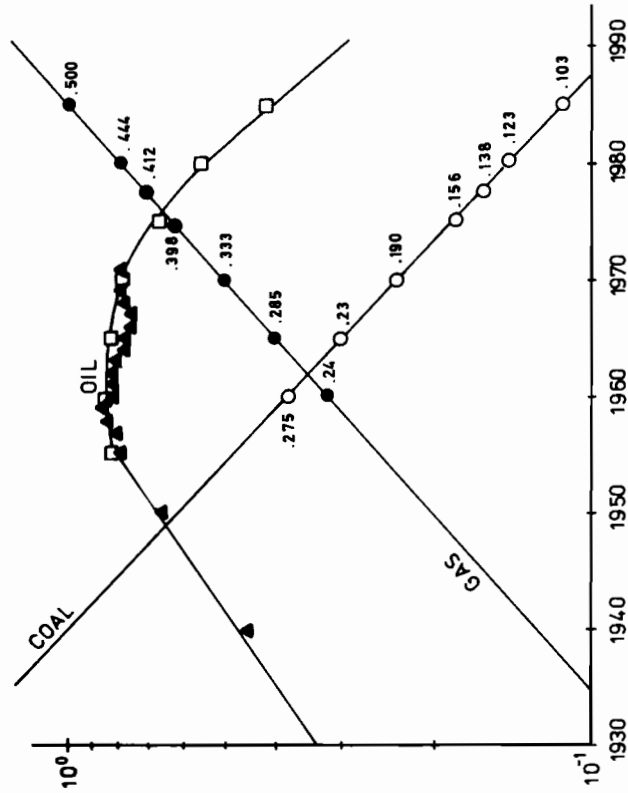

□ calculated values
▲ statistical data

Other symbols and figures represent intermediate steps in the calculation, the graph having been drawn from my notebook.

Figure 7. Forecasting US oil consumption as fraction of total energy consumption from 1930-1940 trends.

predetermined thirty years before, with the only assumption that a new primary source of energy (e.g. nuclear) was not going to play a major role in the meantime. As the history of substitutions shows, however, the time a new source takes to make some inroad in the market is very long indeed, and it takes about a hundred years to achieve dominance after starting from scratch. This assumption appears really unimportant for predictions up to fifty years ahead.

Since our game worked so well in the last 150 years, why not make a try for the next 100 years, just to see what happens? The results are shown in Figures 8, 9 and 10, and some quite important consequences can be drawn from them.

The first consequence is that substitution has a certain internal dynamics largely independent from external factors like final reserves of a certain primary energy source. So the coal share of the market started decreasing in the US around World War I in spite of the fact that coal reserves were in a sense infinite.

The second consequence is that substitution proceeds at a very slow pace, let us say of the order of 100 years to go from 1% to 50%. The "acceleration of the times" which we all perceive does not show up in the statistics. Perhaps the increasing number of changes is giving us that sense of acceleration even if the rate of each individual change stays constant and low.

This fact rules out the possibility of having fusion or solar energy covering a sizable fraction of the energy market before the year 2050 and leaves us with the narrow choice: go nuclear or bust. A resurgence of coal appears improbable too, and I found very nasty reactions on that point from everybody except from coal people who appeared in a sense relieved from a mission well above their forces.

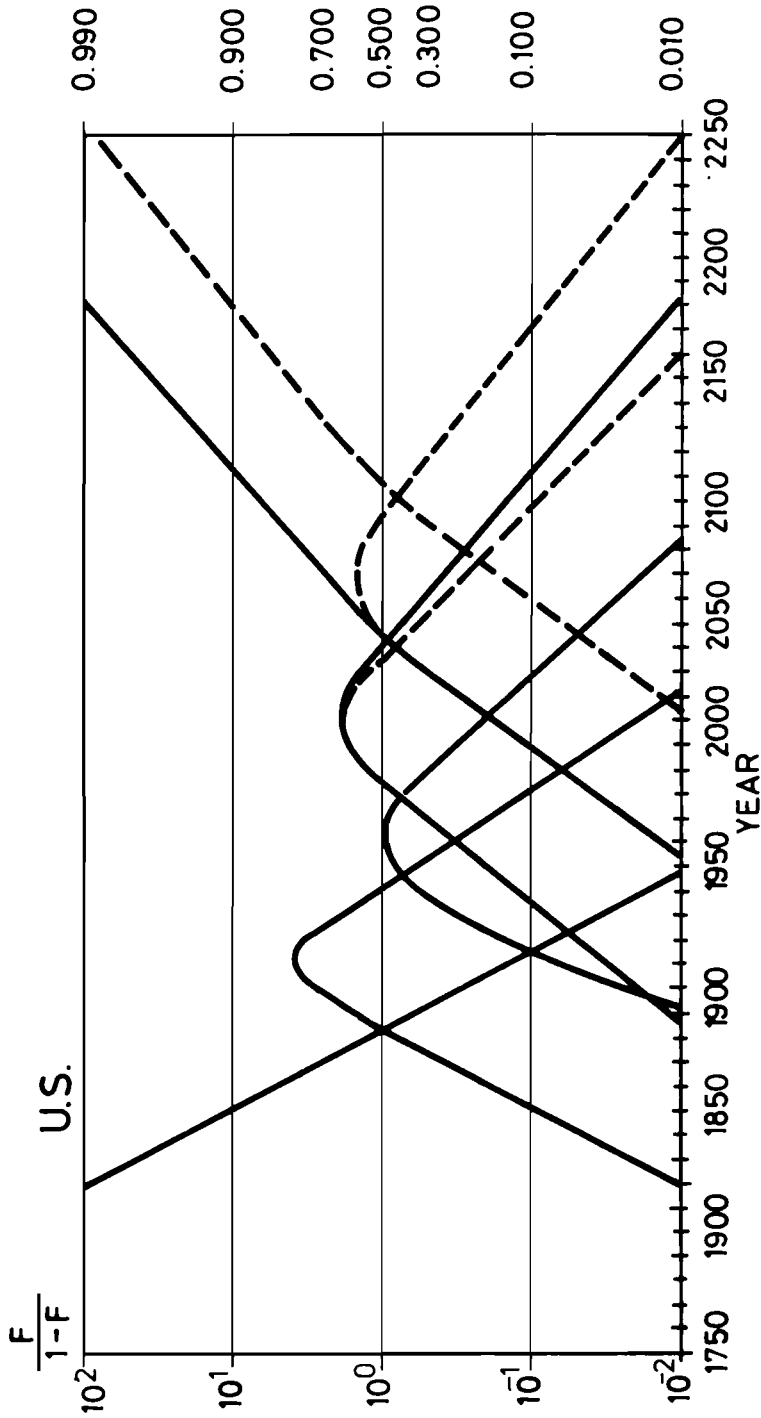

Figure 8. US energy consumption from various sources. Actual fractions are given on the right side of the figure. The effect of the introduction of a new source of energy (solar fusion) is indicated by the dashed lines. Its effect appears to be minimal on conventional sources, and dramatic only on the nuclear.

This figure and the following ones are reported for illustration of the method only and are not intended to have predictive value.

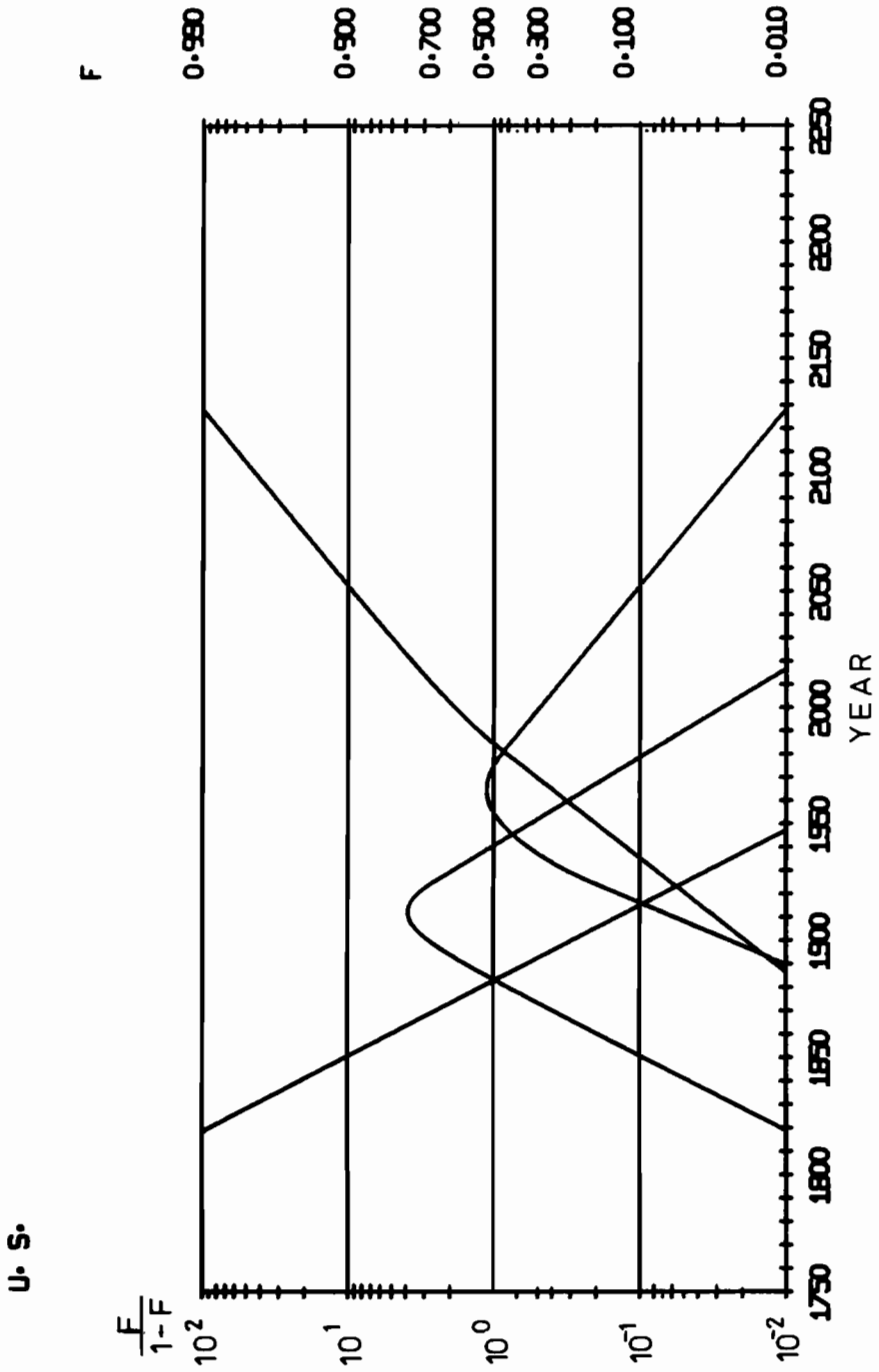

Figure 9. The assumption that no nuclear energy, or new sources will be introduced leads to the absurd situation where all energy input in the US will rely on natural gas.

U. S.

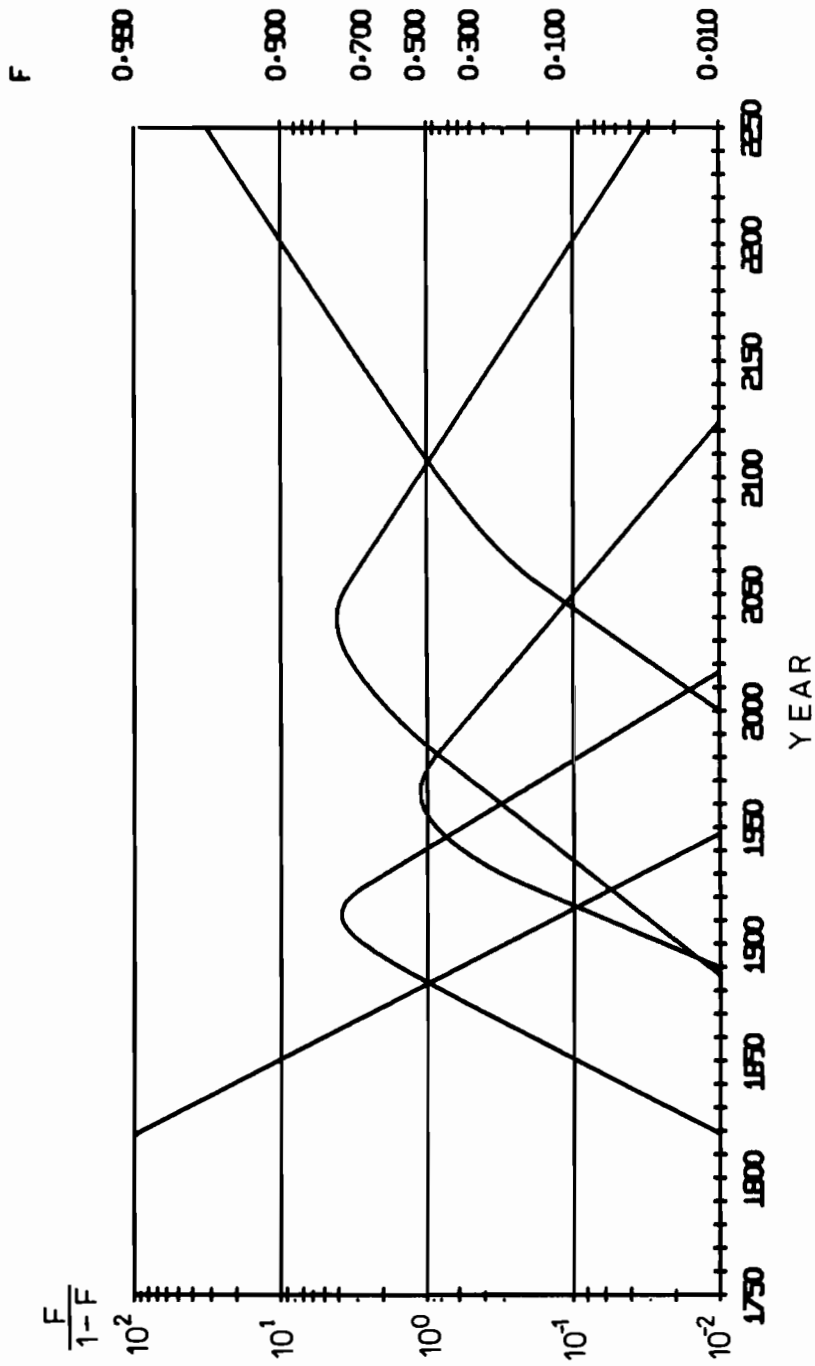

Figure 10. Even the assumption of a moratorium for nuclear energy up to the year 2000 leads to a situation of incompatibility with resources. The introduction of nuclear energy appears a perfectly timed device to make ends meet.

The problem, however, of how to consider a SNG plant, a coal consumer or a primary energy producer, as in fact it is seen from the market, is still an open question. This leaves some ambiguity in the interpretation of the curves in the case of important intertransformation of fuels.

Figures 11 and 12 show the same curves for the world, with different hypotheses concerning the timing and rate of introduction of new sources of primary energy. These curves relate to fractions. To get absolute values, one has to multiply them by the total level of energy consumption. Figure 13 gives the result for the world, using a 2% secular rate of growth, Figure 14 for the US, using two different rates of growth. In both cases, the amount consumed in 1970 is taken as a unity.

In case of scarcity it appears that energy saving is much more efficient than substitution. Phasing out a source does not necessarily mean reduced production in absolute terms. The step following is the integration of this consumption over all the cycle of a certain primary fuel. Then, it is compared with the resources. I did this exercise and found that, after all, the world will not be short of oil if nuclear energy keeps the present rate of penetration and, perhaps, even if not, but there may be problems with natural gas. As everybody has his own figures for the natural gas reserves, I prefer not to raise a row on this point and leave it to you to make comparisons and draw conclusions. After all, the scope of this presentation is essentially methodological.

Productivity versus Energy

People in the world rightfully try to improve their lot, and the numerical indicator for this is GNP. So the linkage between GNP and energy consumption, and the possibility of making this linkage looser than it appears now, are of the

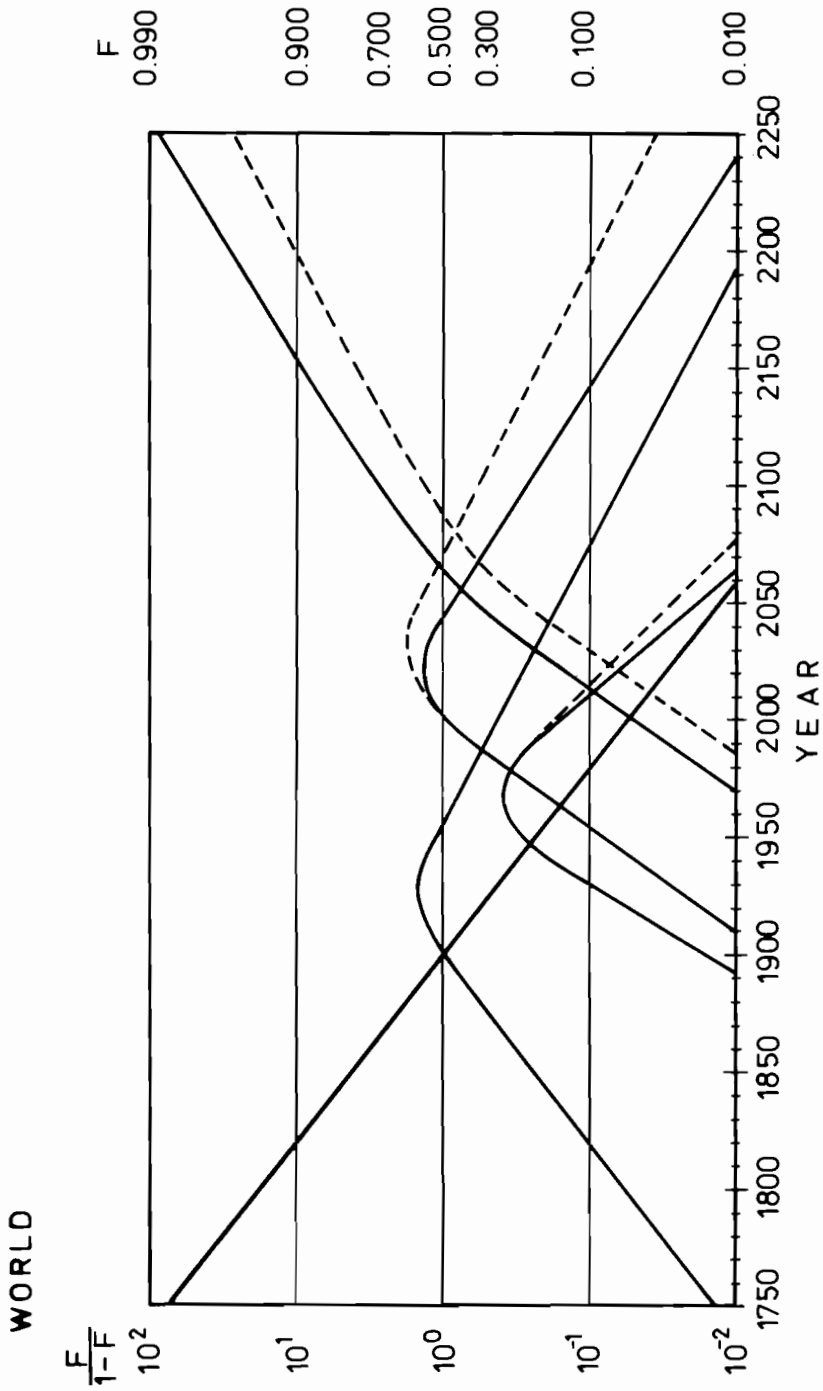

Figure 11. World energy consumption from various sources (fractional). The curves correspond to wood, coal, oil, gas, nuclear, in that order. The dashed lines indicate the effect of a delay in the introduction of nuclear energy. Only gas consumption appears to be heavily affected.

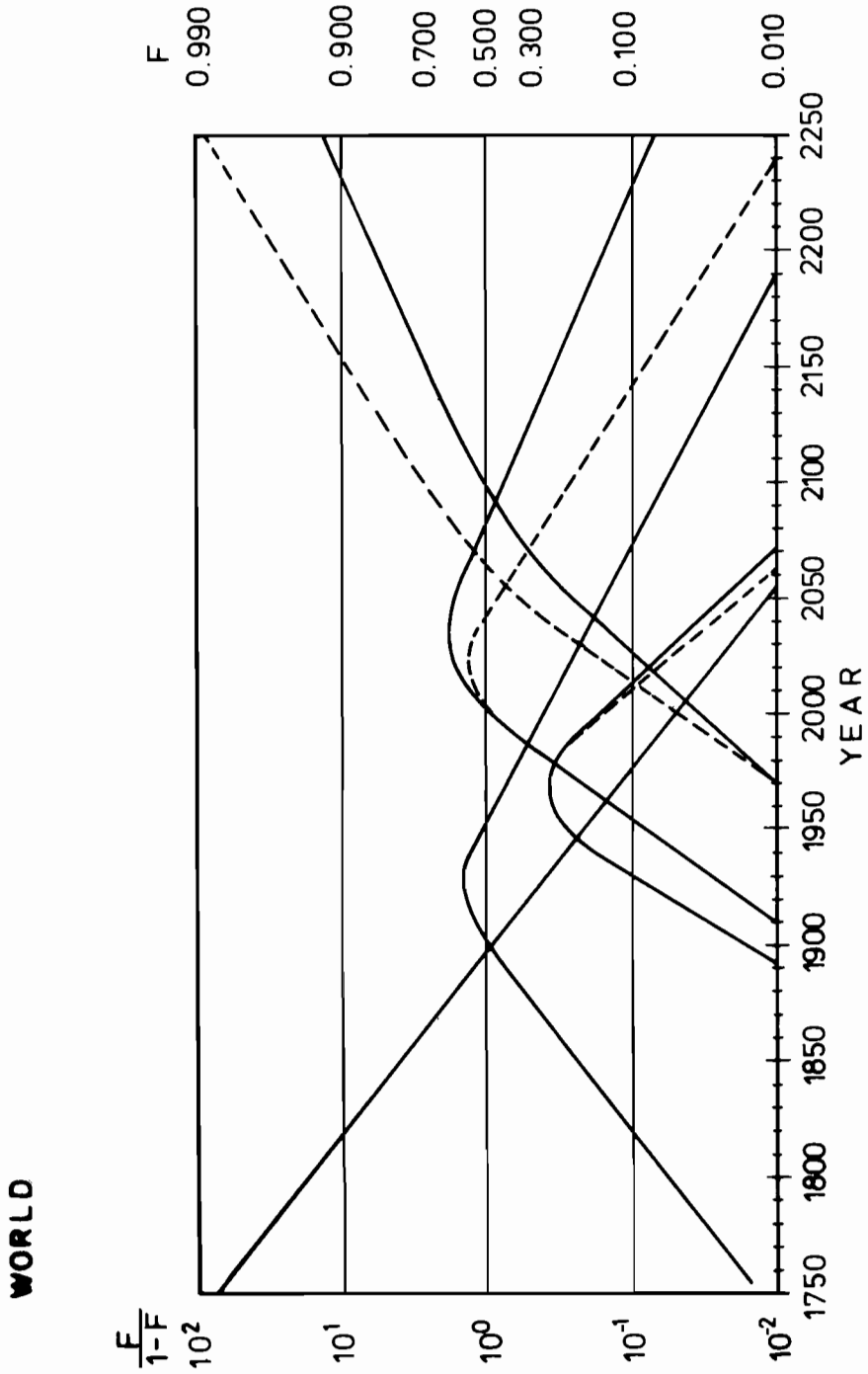

Figure 12. Definitions as in Figure 11. Effect of an accelerated nuclear program (dashed lines). Again only gas consumption appears to be heavily affected.

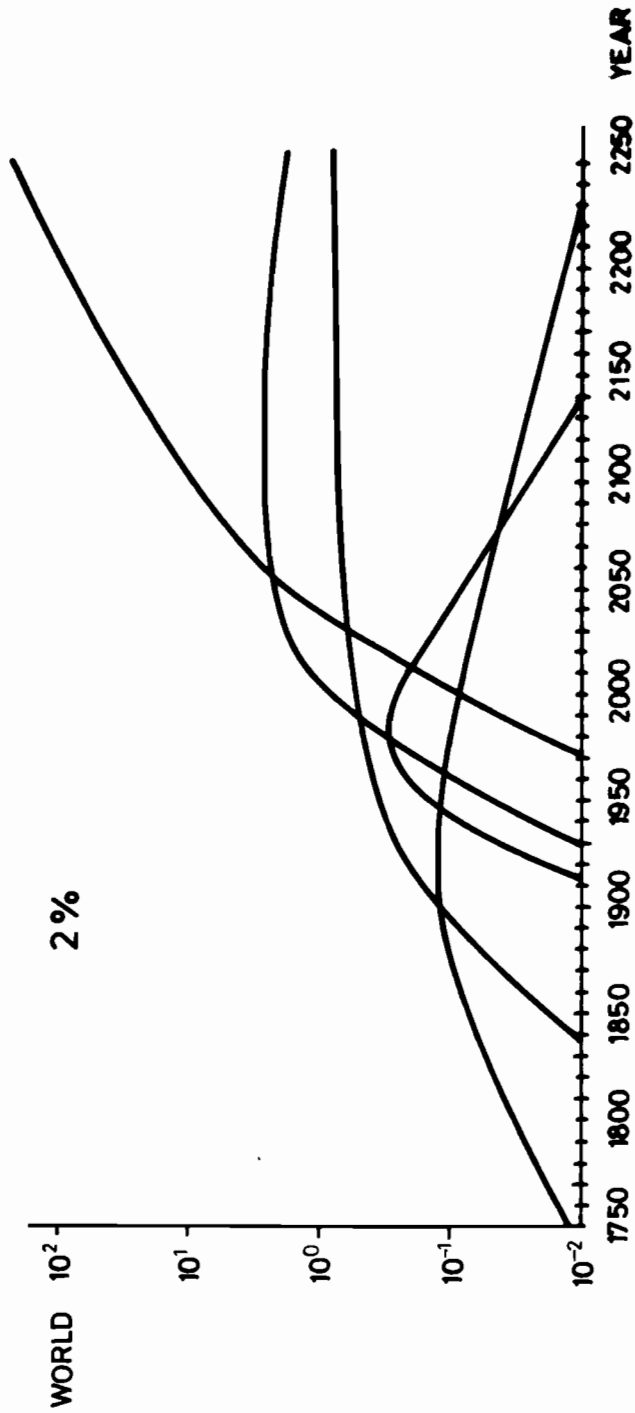

Figure 13. World energy consumption in absolute terms (1970 = 1). Secular growth rate is 2%. The curves correspond, in order, to wood, coal, oil, gas and nuclear energy. It may be observed that, with the hypotheses adapted, the absolute level of coal consumption will reach an asymptotic value and stay constant. Total oil consumption appears compatible with reserves, but this may not be true for gas. The vigorous introduction of a new source of energy during the next twenty years (fusion, solar?) may correct this incongruity and could be considered a demand from the market and not just an optional alternative.

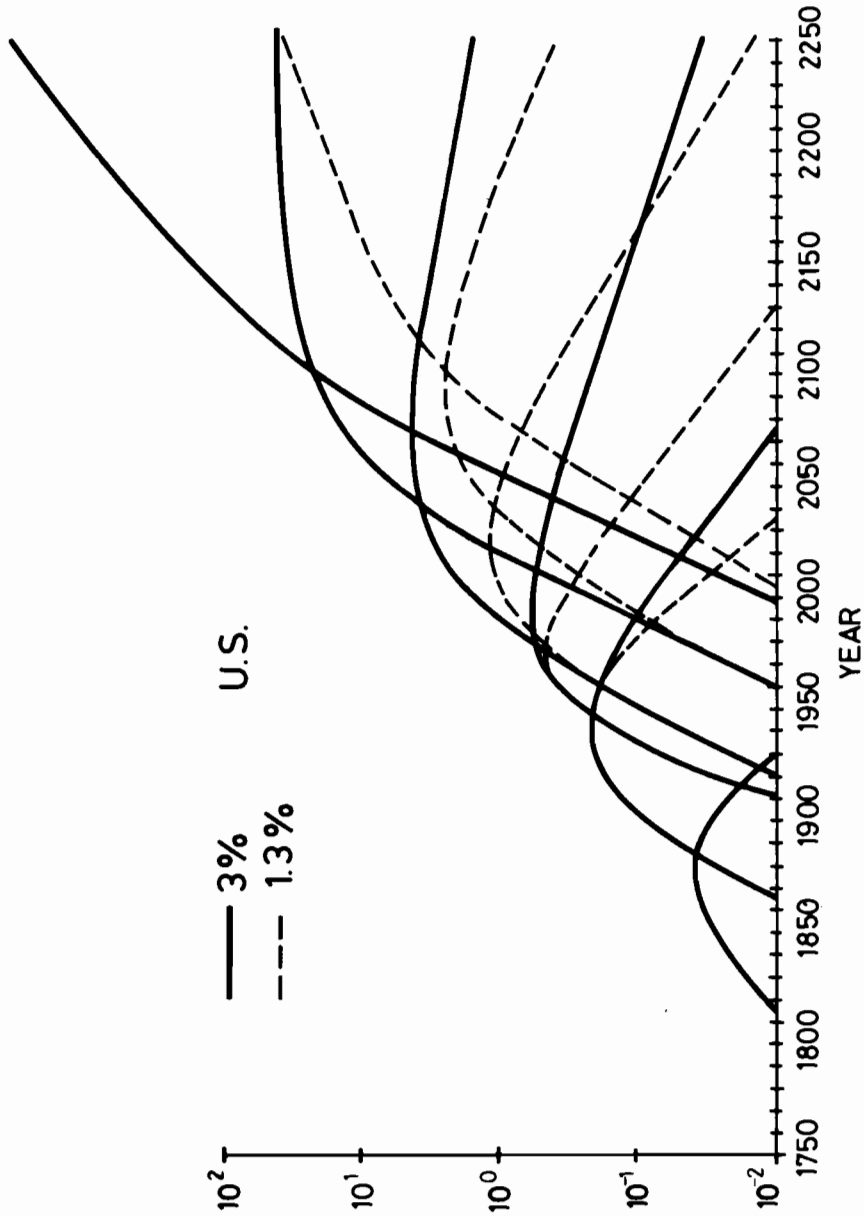

Figure 14. US energy consumption in absolute terms (1970 = 1). A new source of energy is assumed to be introduced around the year 2000. The effect of energy saving, through a reduction of the rate of growth, is indicated by the dashed lines. The value 1.3 for the secular growth has been chosen with the hypothesis that the ratio of per capita consumption in the US and the world remains constant as in the last 100 years, and that the world secular growth in energy consumption stays at 2%.

utmost importance both in order to better understand and plan the working of our society and perhaps have a guess about evolutionary trends. Although I will not be able to draw final conclusions, I hope the next figures will show you that there is much purpose in the research and the linkage is not as rigid and indissoluble as much of the pertinent literature tends to indicate.

History as usual is a good mine for digging and I will start giving a little hint. Figure 15 shows Europe in 1890, a very homogeneous system for technique, cultural and societal organization. But strangely, GNP versus energy consumption organizes in two different lines. In the first, you have the nations who do not have coal mines; in the second, the ones who have. For the same GNP, the ratio of energy consumption between the two groups of nations is four. Large differences also appear if you compare widely different systems such as Pakistan and Sweden or similar nations at differing time periods.

Apart from energy, the other inputs to a productivity function are raw materials, know-how, capital and societal organization, and one may expect a certain degree of substitutability between them. The most convincing analysis in that sense has been made by H. Millendorfer and C. Gaspari [3] and I report here some of the results.

One of the most obvious indicators of the level of know-how is literacy, and in fact the correlations between GNP and literacy work well as shown in Figure 16. The interesting point however, is that the nations of the world, bunched into a certain number of parallel lines, essentially five in all, indicate another factor at work. We may call this the "efficiency parameter" or the "societal efficiency." The different groups are geographically identified in Figure 17. The efficiency of a society seems to correlate strongly with the dominant religion, the society.

EUROPE 1890

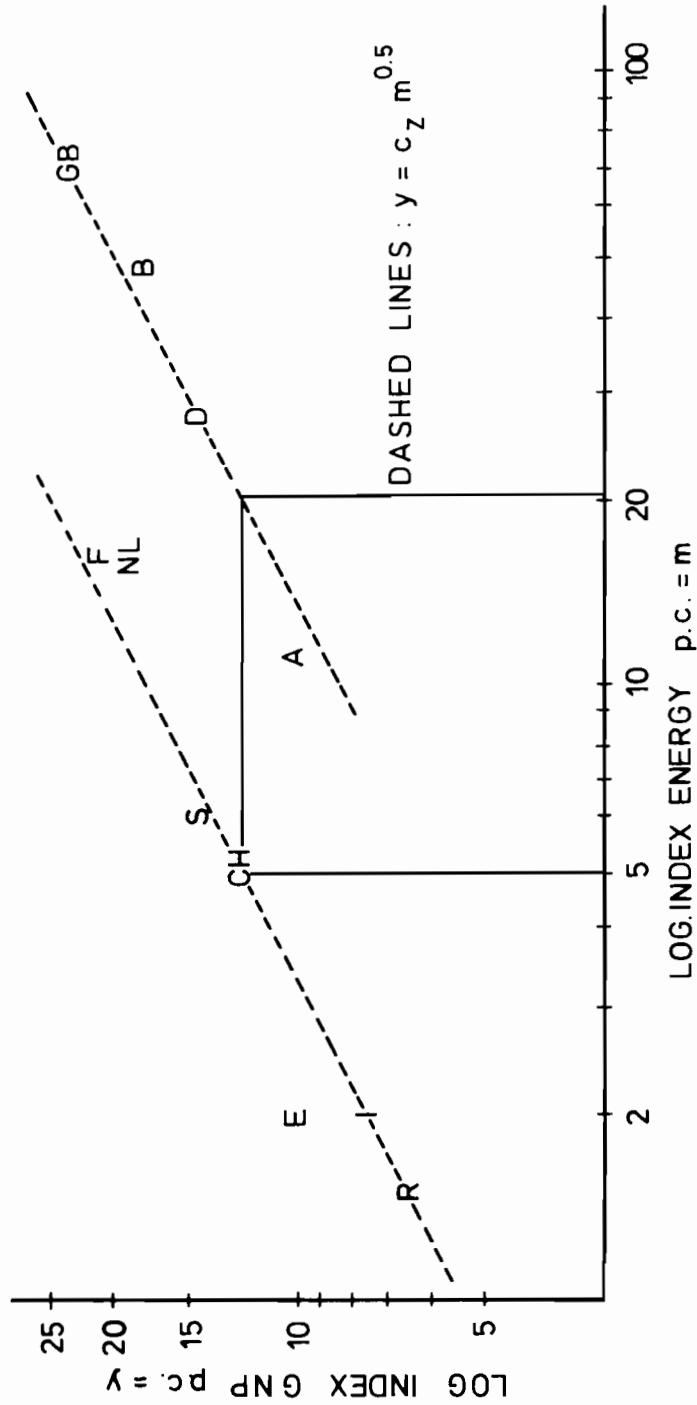

Figure 15. GNP versus energy consumption per capita in Europe in 1890. The separation between coal exporting countries (Austria, Germany, Belgium and Great Britain), and coal importing countries is very sharp. This reveals that the link between GNP and energy consumption is not so rigid as many studies on the subject tend to assume.

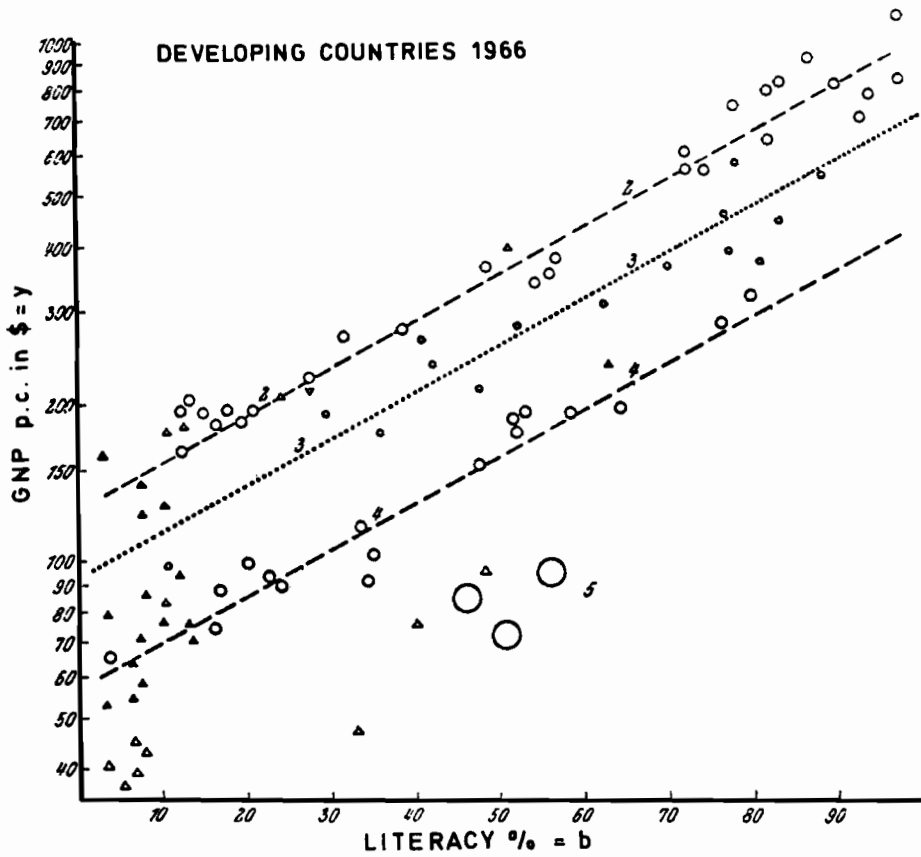

Figure 16. Analysis of GNP versus literacy, separates the countries of the world into four layers. A fifth one is not included because the indicator is saturated. The proper indicator in this case is percentage of engineers in the population.

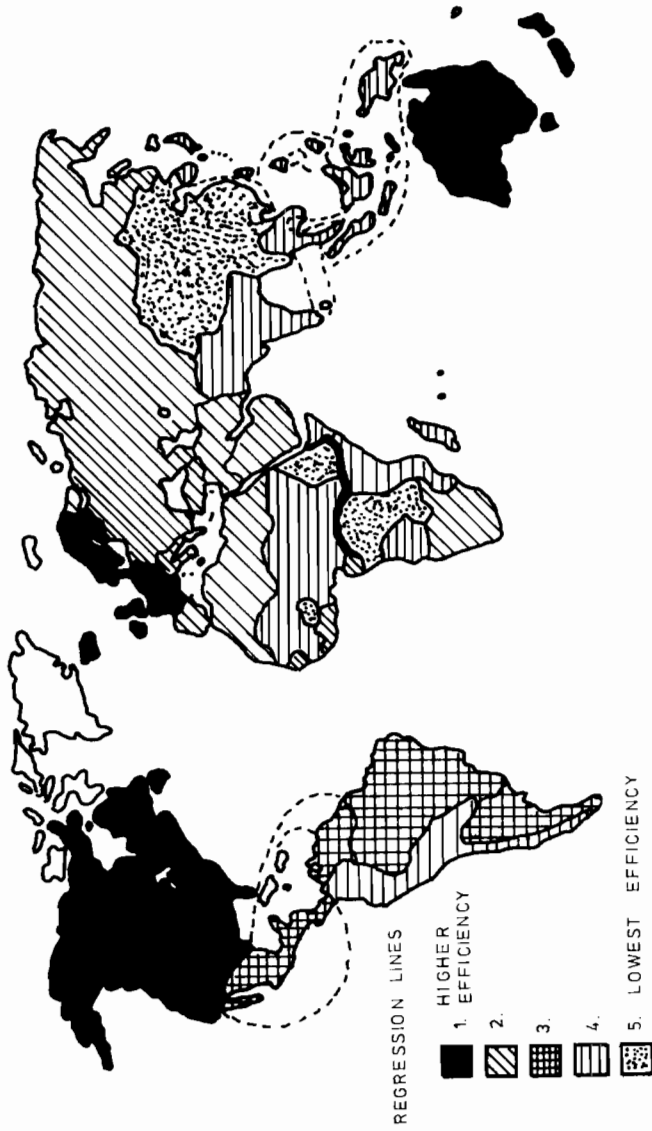

Figure 17. World map of the regions with an equal "societal organization" coefficient. The ratio of the coefficients of levels 2 and 3, or levels 3 and 4, is about 1.4. This means level 3 needs 40% more input than level 2 for the same GNP.

Inside each of the groups, the productivity function becomes:

$$y = C_z m^{1/4} e^b F_s + 0.8q \quad (3)$$

where

- y is the GNP per capita in US dollars;
- C_z is the zonal constant, or societal efficiency;
- m is the indicator for the material input (per capita electricity consumption);
- b is the indicator for the immaterial input (literacy, or engineers/10,000 population when this indicator is saturated);
- q is mineral resources, expressed in per capita value of production;
- F_s is a "stress function" indicating the incomplete substitutability of material and immaterial inputs. $F_s = 1$ for $m^{1/4} = e^b$ and somehow bends the isoquanten as it appears in Figure 18. It is fitted through one parameter only.

$$F_s = \left| \frac{1}{2} \left(\frac{m^{1/4}}{e^b} \right)^{-\rho} + \frac{1}{2} \left(\frac{e^b}{m^{1/4}} \right)^{-\rho} \right|^{-1/\rho}$$

where

ρ is fitted by regression.

The results of the calculations are given in Table 1. The only real departure is for Holland. One interpretation is that it really belongs to the "Catholic" group, i.e. to the second groups with a lower societal efficiency.

The results are graphically displayed in Figure 18 where it appears clearly how different nations have organized themselves, and how a high GNP with a low material input, e.g. energy, can be obtained via a high level of

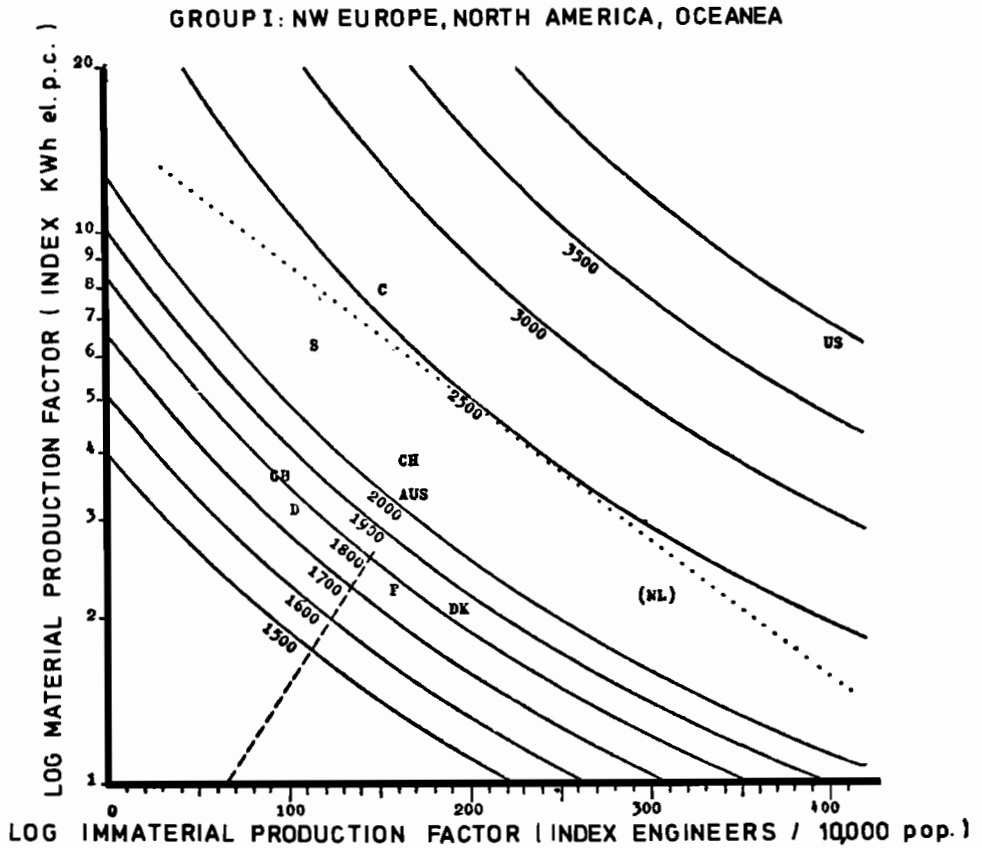

Figure 18. Iso-GNP as a function of the two indicators for material and immaterial inputs. Dashed line indicates their balance, i.e. $m^{14} = e^b$. Dotted line has been drawn for $F_s = 1$ and shows the effect of incomplete substitutability of the production factors. It is very interesting to note that the US and Sweden have roughly the same material index, and the much higher GNP per capita of the US appears to be due essentially to a higher immaterial production factor.

Table 1.

| | Calcu- lated | Ob- served | | Calcu- lated | Ob- served |
|--------------------------------|-----------------|---------------|---------------|-----------------|---------------|
| Canada | 2,540 | 2,380 | Great Britain | 1,830 | 1,700 |
| Australia | 1,970 | 1,970 | Switzerland | 2,150 | 2,310 |
| Belgium | 1,770 | 1,740 | USA | 3,870 | 3,670 |
| Denmark | 1,850 | 1,950 | Sweden | 2,230 | 2,500 |
| France | 1,780 | 1,950 | Holland | (2,250) | 1,520 |
| Federal Republic of Germany | 1,760 | 1,750 | | | |

Note: for 1969--in US dollars per capita.

engineers, i.e. of know-how. It is unfortunate for Japan to have such a low level of societal efficiency, revealing perhaps the difficulty of adapting that society to an economic system developed by a Protestant society. One might, in abstract, speculate on the consequences of trying to adapt western technology to the Japanese society, the reverse of the option taken a century ago.

Conclusion

A new approach in the analysis of the internal dynamics of primary energy substitution and of energy use is attempted. The results are very encouraging and promise a deeper insight into the subtle links between energy use and society operation.

APPENDIX

Methods of Calculation

N. Nakicenovic

We will describe here the first attempt to implement the ideas presented in the paper for determining the market penetration behavior of energy sources on the basis of the historical data. First, by definition, the sum of all fractional market shares must be always equal to 1:

$$\sum_{i=1}^n F_i(t) = 1 \quad (4)$$

where $F_i(t)$ is the fraction of market penetration of the source i and n is the number of energy sources. Expression (4) must hold for all t .

As shown in the paper, the logistic functions appear to give a good description of the market share of a given product. These logistic functions can be written as:

$$\ln \left[\frac{F_i(t)}{1 - F_i(t)} \right] = \alpha_i^0 t + c_i^0 \quad (5)$$

The superscript 0 for parameters α_i and c_i will indicate that those parameters are defined on the basis of historical data. Equation (4) can be rewritten:

$$F_i(t) = \frac{\exp(\alpha_i^0 t + c_i^0)}{1 + \exp(\alpha_i^0 t + c_i^0)} \quad (6)$$

Our intention is to project the market penetration trends of the primary energy sources over the time interval longer than the time period for which data are available.

This projection in the future leads to situations where one or more energy sources are penetrating the market at a higher rate than other energy sources leaving the market. Thus, in such situations expressions (4) and (6) would be contradictory. The expression (4) is a statement by definition and cannot be violated. Therefore, the logistic function in expression (6) cannot hold for the whole time interval in question and for all energy sources which are leaving the market from the beginning.

The method used is that the oldest still growing energy source must decrease, that is the expression (6) would not hold for that, oldest, energy source from that time point on, and will be equal to the difference between one and the sum of all other energy sources. By oldest we mean the energy source which is anterior to all other energy sources. This chosen energy source then enters a transition period after which the market share starts decreasing. When this decrease starts, the originally second oldest still growing energy source must be labeled "oldest."

We assume that there are n energy sources competing on the market so that any energy is denoted by $i \in [1, n] \leq 1$. We want to consider a time period longer than the historical period for which data are available:

$$t \in [t_{INI}, t_{FIN}] \subseteq \mathbb{R}^+ .$$

At the beginning we choose, as described above, the oldest still growing energy source j by:

$$j = \{i | i = [1, n] \subseteq \mathbb{N}, t = t_{INI}, \alpha_i^0 \geq 0, \alpha_{i-1}^0 < 0\} \quad (7)$$

As already described above, for all other energy sources that are leaving the market, that is $\alpha_i^0 < 0$, expression (6) always holds. For the oldest still growing energy source j , we define the market penetration by:

$$F_j(t) = \begin{cases} \frac{\exp(\alpha_j^0 t + c_j^0)}{1 + \exp(\alpha_j^0 t + c_j^0)} & \text{for } t_{INI} \leq t \leq t_{bj} \text{ (ascending phase)} \\ 1 - \sum_{i \neq j} F_i(t) & \text{for } t_{bj} \leq t \leq t_{ej} \text{ (transition phase)} \\ \frac{\exp(\alpha_j^* t + c_j^*)}{1 + \exp(\alpha_j^* t + c_j^*)} & \text{for } t_{ej} \leq t \leq t_{FIN} \text{ (descending phase)} \end{cases} \quad (8)$$

In the following we will explain the quantities introduced by (8). First we define t_{bj} and t_{ej} as these are instrumental in defining the transition phase:

$$t_{bj} = \min\{t | t \in [t_{INI}, t_{FIN}] \subseteq \mathbb{R}^+, \frac{\exp(\alpha_j^0 t + c_j^0)}{1 + \exp(\alpha_j^0 t + c_j^0)} + \sum_{i \neq j} F_i(t) > 1\} \quad (9)$$

and:

$$t_{ej} = \{t | t \in [t_{bj}, t_{FIN}] \subseteq \mathbb{R}^+, \frac{d[\ln(\frac{F_j(t)}{1 - F_j(t)})]}{dt} = c \text{ or } c \in \mathbb{R}, F_j(t) = F_j(t_{bj})\} \quad (10)$$

where c is a constant.

Phrase t_{bj} is, therefore, the beginning of the transition period for energy source j . It denotes the time point where the rate of market penetration of energy source j starts to fall. Phrase t_{ej} is the end of this transition period, when the market penetration of energy source j follows the logistic function again (see Figure 19).

Finally we define α_j^* and c_j^* by:

$$\alpha_j^* = \frac{d[\ln(\frac{F_j(t)}{1 - F_j(t)})]}{dt} \quad (11)$$

and

$$c_j^* = \ln(\frac{F_j(t)}{1 - F_j(t)}) - \alpha_j^* t \quad (12)$$

at time point $t = t_{ej}$.

Beyond t_{ej} the energy source market penetration follows then the logistic function in the descending mode, i.e. $\alpha_j^* < 0$. All of the quantities on the right hand side of expression (8) are now defined, and therefore also the market penetration behavior of the energy source j .

The energy source j thus defined, however, is only the first energy source that must leave the market due to definition in expression (4). As the time goes on we might still encounter the problem that we must reduce the current, oldest still growing energy source. Accordingly, we go through the process source by source. Generally, we therefore have:

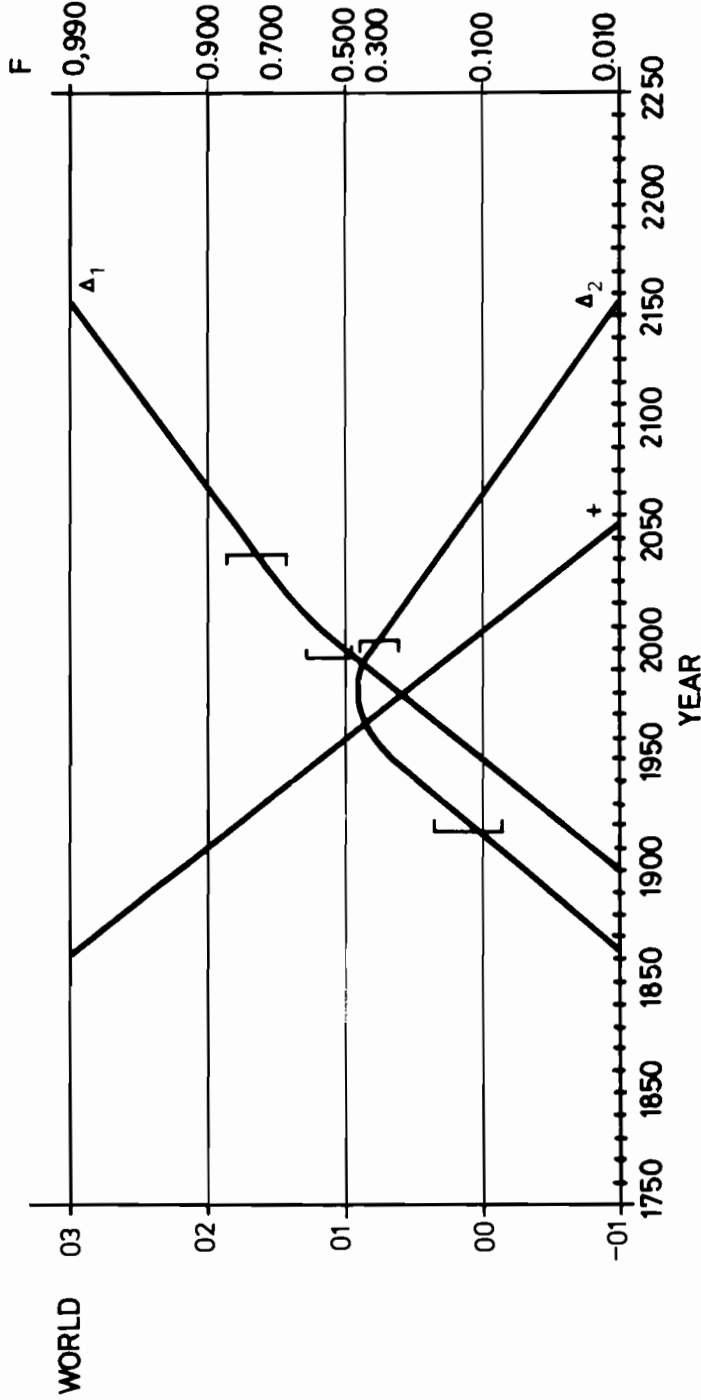

Figure 19. There are three energy sources: for the first energy source (+) $\alpha_1(t) = 0$ for all t ; for the second energy source (Δ_1) $\alpha_2(t) > 0$ for $t < tb_2$; for the third energy source (Δ_2) $\alpha_3(t) > 0$ for $t < tb_3$. For time period $te[te_2, te_3]$: $F_2(t) = 1 - F_1(t) - F_3(t)$, and elsewhere $F_2(t) = \frac{\exp[\alpha_2(t)t + c_2(t)]}{1 + \exp[\alpha_2(t)t + c_2(t)]}$. Transition period is in brackets.

$$j = \{i | i \in [1, n] \subseteq \mathbb{N}, t = [t_{INI}, t_{FIN}] \subseteq \mathbb{R}^+, \alpha_j(t) \geq 0,$$

$$\alpha_{i-1}(t) < 0\} \quad (7^*)$$

where

$$\alpha_j(t) = \begin{cases} \alpha_j^0 & \text{if } \alpha_j^0 < 0 \text{ for } t_{INI} \leq t \leq t_{FIN} \\ \alpha_j^0 & \text{if } \alpha_j^0 > 0 \text{ for } t_{INI} \leq t < t_{bj} \\ \alpha_j^* & \text{if } \alpha_j^0 \geq 0 \text{ for } t_{ej} \leq t \leq t_{FIN} \end{cases} \quad (13)$$

and similarly

$$c_j(t) = \begin{cases} c_j^0 & \text{if } \alpha_j^0 < 0 \text{ for } t_{INI} \leq t \leq t_{FIN} \\ c_j^0 & \text{if } \alpha_j^0 \geq 0 \text{ for } t_{INI} \leq t < t_{bj} \\ c_j^* & \text{if } \alpha_j^0 \geq 0 \text{ for } t_{ej} \leq t \leq t_{FIN} \end{cases} \quad (14)$$

Finally expression (8) becomes:

$$F_j(t) = \begin{cases} \frac{\exp[(\alpha_j(t)t + c_j(t)]}{1 + \exp[(\alpha_j(t)t + c_j(t)]} & \text{for } t < t_{bj} \text{ or } t \geq t_{ej} \\ 1 - \sum_{i \neq j} F_j(t) & \text{for } t_{bj} \leq t < t_{ej} \end{cases} \quad (8^*)$$

To summarize, it follows from the relations presented above that $\alpha_i(t)$ and $c_i(t)$ are piecewise defined for those energy sources which penetrate the market and later must leave it. They are not defined over the time interval $[t_{bi}, t_{ei}]$. During this interval equation (4) is employed to govern the behavior of the energy source in transition. Those energy sources which have the descending market penetration from the beginning of the time period analyzed, have $\alpha_i(t)$ and $c_i(t)$ defined over the whole time period. The definition for this is:

$$\alpha_i(t_{INI}) = \alpha_i^0 < 0.$$

We developed a computer code for expressions (7) through (14). The initial values of parameters α_i^0 and c_i^0 were determined on the basis of historical data. The program then generated the values of $F_i(t)$ for any chosen interval of time between $t > 0$ and $t < \infty$.

In order to express consumption of different energy sources in absolute terms, a base year $t_0 = 1970$ is given as input and a constant growth rate (r) for total energy consumption is given. The consumption in the base year for each source has been taken as unity for this source.

The source code for this program was written in Fortran. It has been implemented on the PDP11/45 with DOS version V07 operating system and later with UNIX operating system. The graphical software used in the program is a version of Calcomp plotting library specifically modified for PDP11/45.

Attached is the flow chart of this program (see Figure 20), and the listing of the version of the source program run under the DOS operating system (see Table 2).

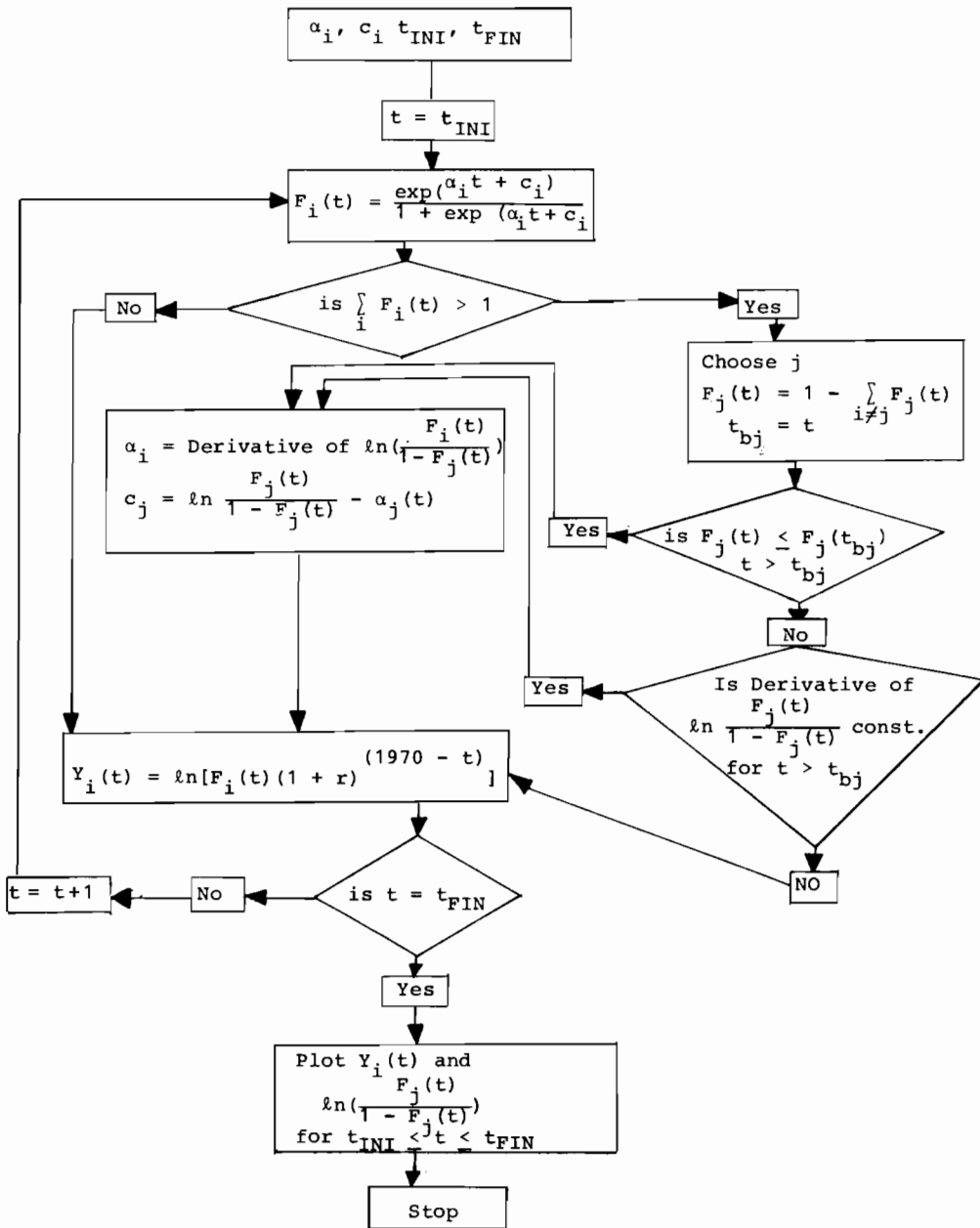

Figure 20.

Table 2. Source program.

```

DIMENSION Y(6),F(6),A(6),B(6),ARE(6),AA(6),AB(6)
DIMENSION G(6,501),TL(6,501),REF(6)
DIMENSION TITLE(10),TYPE(6,4),YLOGM(6)
READ (5,60) W
READ (5,60) MAX
READ (5,60) MIN
READ (5,60) IREFY
READ (5,50) RG
READ (5,50) RG1
READ (5,50) ERROR
READ (5,60) NP
READ (5,90) (TITLE(I),I = 1,10)
DO 20 I = 1,N
READ (5,130) (TYPE(I,J),J = 1,4)
20 CONTINUE
WRITE (6,40)
WRITE (6,170) NP
WRITE (6,40)
DO 1 I = 1,N
READ (5,100) X1, F1
WRITE (6,140) X1, F1
READ (5,100) X2, F2
WRITE (6,140) X2, F2
Y1 = ALOG(F1)
Y2 = ALOG(F2)
CALL FUNC(Y1,Y2,X1,X2,A(I),B(I))
1 CONTINUE
WRITE (6,40)
40 FORMAT (1H)
50 FORMAT (F5.3)
60 FORMAT (14)
70 FORMAT (E8.1)
80 FORMAT (' E = LOG(F/(1-F)) = A*T+C')
90 FORMAT (10A2)
100 FORMAT (F5.0,F5.3)
110 FORMAT ('F')
120 FORMAT (4A2,' TOTAL AMOUNT CONSUMED = ',E14.7)
130 FORMAT (4A2)
140 FORMAT (1H,3(10X,E14,7))
150 FORMAT (10X,'CONSUMED BEFORE ',14,' = ',E14.7)
160 FORMAT (10X,'CONSUMED AFTER ',14,' = ',E14.7)
170 FORMAT (10X,'PLOT # ',12)
180 FORMAT (10X,'TOTAL CONSUMPTION IN ',14,' IS 1')
190 FORMAT (10X,'GROWTH RATE (RG) BEFORE ',14,' = ',F5.3)
195 FORMAT (10X,'GROWTH RATE (RG) AFTER ',14,' = ',F5,3)

```



```

200  FORMAT (1H10X,F6.0,6(10X,F6.4))
210  FORMAT (' R = F*(1+RG)**(',14,'-T)')
220  FORMAT (1H ,14,10X,2(10X,E14.7))
      XMAX = FLOAT(MAX)
      XMIN = FLOAT(MIN)
      X1MIN = XMIN-50.
      X3MIN = XMIN-70
      M1 = (MAX-MIN)/10
      YMAX = .1E+3
      YMIN = .1E-1
      YMAXL = ALOG(YMAX)
      YMINL = ALOG(YMIN)
      YL = ALOG(.5*YMIN)
      XM = -1
      RG2 = RG

12   CONTINUE
      CALL P1130
      CALL FPLOT(1,3.,3.)
      CALL SCALF(1.,1.,0.,0.)
      CALL FPLOT(1,3.,0.)
      CALL YLOGA(YMIN,YMAX,.01,4,5.,0.,XMIN,.02,SCY)
      CALL FORID(0,XMIN,YMINL,10.,M1)
      DO 8 I/MIN.MAX.50
      XI = FLOAT(I)-13.
      CALL FOMAR(XI,YL,.12,.15,0.)
      WRITE (Y,60) I

8    CONTINUE
      CALL FOMAR(X3MIN,YMINL,.12,.15,0.)
      WRITE (7,70) YMIN
      BE = YMIN
      DO 7 J = I,N
      BL = DE*10
      BEL = ALOG(BE)
      CALL FOMAR(X311IN,BEL,.12,.15,0.)
      WRITE (7,70) BE

7    CONTINUE
      T(T1 = ALOG(YMAX*9.)
      CALL 50MAR(X3MIN.TIT1,.12,.15,0.)
      IF (XM.GY.0 ) GO TO 30
      WRITE (2.50)
      GO TO 31

30   CONTINUE
      WRITE (7,210) IREFY

31   CONTINUE
      IF (XM.GT.0.) GO TO 37
      YHIG = YMIN
      DO 25 I = 1,N
      YHIG = YMIG*10.
      YHIGL = ALOG(YHYG)
      CALL FPLOT(1,XMIN,YHIGL)
      CALL FPLOT(2,XMAX,YHIGL)

25   CONTINUE

37   CONTINUE
      CALL FPLOT(1,XMAX,YHIG)
      TITH = ALOG(YMAX*15.)

```

```

CALL FCHAR(XMIN,TITH,.12,.15,0.)
WRITE (7,90) (TITLE(K1),K1 = 1,4)
IF (XM.GT.O.) GO TO 13
YI = 0
FI = 0
J = 1
SLOPE = 100.
DO 2 I = MIN,MAX
SUM = 0
X = FLOAT(X)
II = I-MIN+1
IF (A(J).LT.0.) J = J+1
DO 3 M = 1,N
Y(M) = A(M)*X+B(M)
F(M) = 1.-(1./(1.+EXP(Y(M))))
SUM = SUM + F(M)
3 CONTINUE
IF (SUM.EQ.1.) GO TO 6
F(J) = 1.-SUM+F(J)
IF (F(J).LT.1.E-6) GO TO 4
AB(J) = AREAB/REF(J)
AA(J) = AREA/REF(J)
IF (TL(J,MAX-MIN+1).LE.0.) TL(J,MAX-MIN+1)=YMIN
TL(J,MAX-MIN+1)=ALOG(TL(J,MAX-MIN+1))
27 CONTINUE
WRITE (6,40)
DO 10 K = 1,N
CALL FPLOT(-2,XMIN,G(K,1))
K5 = 50
DO 11 I = MIN, MAX
II = I-MIN+1
IF (II.EQ.K5) GO TO 21
GO TO 22
21 CONTINUE
K5 = K5+50
22 CONTINUE
X = FLOAT(I)
CALL FPLOT(0,X,G(K,II))
11 CONTINUE
CALL FPLOT(1,XMAX,G(K,II))
10 CONTINUE
XMIN1 = XMIN+20.
CALL FPLOT(1,XMAX,YMINL)
CALL YLOGA(YMIN,YMAX,.01,4,5.,0.,XMIN,.02,SCY)
CALL FCHAR(XMIN1,YMINL,.12,.15,0.)
FMIN=YMIN/(1.+YMIN)
WRITE (7,50) FMIN
DO 17 I=1,9,2
YVA=FLOAT(I)/10.
YLA = ALOG(YVA/(1. = YVA))
CALL FCHAR(XMIN1,YLA,.12,.15,0.)
WRITE (7,50) YVA

```

```

17  CONTINUE
    CALL FCHAR(XMIN1,YMAXL,.12,.15,0.)
    FMAX=YMAX#(1,+YMAX)
    WRITE (7,50) FMAX
    CALL FCHAR(XMIN1,TIT1,.12,.15,0.)
    WRITE (7,110)
    XMO = XMIN+150.
    CALL FPLOT(1,XMAX,YMINL)
    XM = 1.
    CALL SCALF(1.,1.,0.,0.)
    CALL FPLOT(1,1.,-3.)
    GO TO 12

13  CONTINUE
    DO 14 K = 1,N
    CALL FPLOT(-2,XMIN,TL(K,I))
    K5 = 50
    DO 15 I = MIN,MAX
    II = I-MIN+1
    IF (II.EQ.K5) GO TO 23
    GO TO 24

23  CONTINUE
    K5 = K5 +50

24  CONTINUE
    X = FLOAT(I)
    CALL FPLOT(0,X,TL(K,II))

15  CONTINUE
    CALL FPLOT(1,XMAX,TL(K,II))

14  CONTINUE
    Y(J) = ALOG(F(J)/(1.-F(J)))
    SLOPEN = Y(J)-YI
    IF (SLOPEN.EQ.0.) GO TO 36
    SDIFF = SLOPE/SLOPEN
    ERT1 = 1.-ERROR
    ERT2 = 1.+ERROR
    IF (SDIFF.GE.ERT1.AND.SDIFF.LE.ERT2.AND.SLOPEN.GT.0.) YLOGM(J)=

36  CONTINUE
    IF (SLOPE.LT.0..AND.F(J).LE.YLOGM(J)) GO TO 5
    IF (SDIFF.GE.ERT1.AND.SDIFF.LE.ERT2.AND.SLOPE.LT.0.) GO TO 5
    YI = Y(J)
    FI = F(J)
    SLOPE = SLOPEN
    GO TO 6

4   CONTINUE
    F(J) = 1.E-5
    Y(J) = ALOG(F(J)/(1.-F(J)))
    YI = Y(J)
    FI = F(J)

5   CONTINUE
    CALL FUNC(Y(J),YI,X,X - 1.,A(J),B(J))
    J = J+1
    Y1 = 0.
    FI = 0.
    SLOPE = 100.

```

```

6  CONTINUE
   DO 9 K = 1,N
   G(K,II) = Y(K)
   IF (Y(K).GT.YMAXL) G(K,II) = YMAXL
   IF (Y(K).LT.YMINL) G(K,II) = YMINL
   IF (I.GT.IREFY) RG = RG1
   XM = (1.+RG)**(I-IREFY)
   IF (I.EO.IREFY) REF(K) = F(K)
   XM = F(K)*XM
   IF (XM.LT.YMIN) XM = YMIN
   TL (K,II) = XM

9  CONTINUE

2  CONTINUE
   I1 = MAX-1
   DO 27 J = 1,N
   AREA = 0.
   AREAAB = 0.
   AREAAB = 0.
   AREA25 = 0.
   I25 = 0
   DO 19 I = MIN,I1
   II = I-MIN+1
   XM = (TL(J,II)+TL(J,II+1))/2.
   IF (TL(J,II+1).LT..01) XM = 0.
   IF (TL(J,II).LE.0.) TL(J,II) = YMIN
   TL(J,II) = ALOG(TL(J,II))
   AREA.AREA+XM
   IF (I.GE.IREFY) GO TO 28
   AREAAB = AREAAB+XM
   GO TO 29

28  CONTINUE
   AREAAB = AREAAB+XM

29  CONTINUE

19  CONTINUE
   ARE(J) = AREA/REF(J)
   CALL SCALF(1.,1.,0.,0.)
   CALL FPLOT(1,1.,-3.)
   CALL P1130
   CALL FPLOT(1,3.,3.)
   CALL SCALF(1.,1.,0.,0.)
   XM01 = 1.
   XM02 = 0.
   CALL FCHAR(XM01,0.,.12,.15,0.)
   WRITE (7,180) IREFY
   CALL FCHAR(XM01,-.3,.12,.15,0.)
   WRITE (7,190) IREFY,RG2
   CALL FCHAR(XM01,-.3,.12,.15,0.)
   WRITE (7,190) IREFY,RG1
   DO 16 J = 1,N
   HIG = FLOAT(J)
   HIG1 = HIG-.3
   HIG2 = HIG1-.3
   CALL FPLOT(-2.XM02,HIG)
   CALL FPLOT(1,XM02,HIG)
   CALL FCHAR(XM01,HIG,.12,.15,0.)
   WRITE (7,120) (TYPE(J,K3),K3 = 1,4),ARE(J)
   CALL FCHAR(XM01,HIG1,.12,.15,0.)
   WRITE (7,150) IREFY,AB(J)

```

```
CALL FCHAR(XM01,HIG2,.12,.15,0.)
WRITE (7,160) IREFY,AA(J)
16 CONTINUE
HIG = FLOAT(N+1)
CALL FCHAR(XM02,HIG,.24,.3,0.)
WRITE (1,1.0) NP
CALL SCALF(1.,1.,0.,0.)
CALL FPLOTT(1,3.,-3.)
CALL FPLOTT(2,3.1,-3.)
CALL FPLOTT(1,3.1,-3.)
STOP
END

SUBROUTINE FUNC(Y1,Y2,X1,X2,A,B)
A = (Y1-Y2)/(X1-X2)
B = Y2-A*X2
RETURN
END
```

References

- [1] Fisher, J.C., and Pry, R.H. "A Simple Substitution Model of Technological Change." G.E. Report 70-C-215 (June 1970).
- [2] Lapp, R.E. The Logarithmic Century. Englewood Cliffs, N.J., Prentice Hall, 1973.
- [3] Millendorfer, H., and Gaspari, C. "Immaterielle und Materielle Faktoren der Entwicklung." Zeitschrift fuer Nationaloekonomie, 31 (1971), 81-120.
- [4] Pry, R.H. "Forecasting the Diffusion of Technology." G.E. Report 73-CRD-220 (July 1973).

DiscussionRoss

Marchetti showed me an interesting paper of his which I have yet to digest. I think his comments are on the whole essentially correct. In my paper I have overstated the case regarding the demonstration of a limit. I think, however, the essence of the limit is an equation in the paper. I really intended it to be defining a limit, or an optimum situation; it is more of a conceptual process than a real one for reasons of complexity. Examining these constraints on population, one ascertains physically whether one can maintain the production to satisfy a certain population size and yet maintain other nonphysical qualities of life within the civilization. If the answer is no, then you must reduce the population or else accept less of the physical resources. Somehow, that to me is really the ultimate in determining what is an appropriate level of population, and what is an appropriate life-style. The decisions have to be made explicitly, taking into account the ability of the surrounding environment to support the population.



VI. REVIEW AND DISCUSSIONS OVERVIEW



General Discussion and OverviewHäfele

The first and for me, perhaps, most important question is the following: Energy demand and energy conservation to me will be most important over the next fifteen years or so. Thereafter, we will begin to see the transition to the supply of either non-fossil fuels or fossil fuels such as coal that are quite abundant. Thus the resource constraints will be less severe than now or in the past. There is more than one option for doing this, or at least let us assume for a minute that this is the case. All these transitions from a fuel-resource-constrained society into a nonfuel-resource-constrained society require tremendous capital investments.

This morning we touched briefly on the case of India, but to some extent every society is capital constrained. Now what is best if you have a certain demand for capital? Should capital investments be made for further energy conservation or should they be made for the transition into nonresource constrained technologies? My personal impression is that up to a point it is appropriate to make the investment for energy conservation, such as the increase of insulation of houses or pipelines. But beyond a point the capital investment becomes very high, so if you run up to the last percent of energy conservation, it may be more appropriate to invest that scarce capital into the new technologies where you are essentially not resource limited. Therefore, my question is whether someone of you could perhaps express a feeling about the cross-over point. Beyond how many dollars per kilowatt is it no longer appropriate to invest in energy conservation.

Taylor

I would answer this in terms of the argument put forth by Nordhaus in the Brookings Papers. What Häfele is saying is

that we are currently constrained by fuel resources, but that in fifteen years or so capital will be the constraint. Put differently, if you call a technology that is in no way resource constrained a "backstop technology," then you are arguing that in fifteen years we will have an available, if not an economical, backstop technology. The question then is, when is the backstop technology the best technology to choose? Is it cheaper to choose the backstop technology or to spend some of that on conservation, that is, demand reduction? The basic point is that we are evolving from a resource-constrained to a capital-constrained economy.

I think the biggest problem we face in the US with regard to energy policy is our politicians. If they would let the market operate, and not insist on controlling oil and natural gas prices, the transition from resource-intensive to capital-intensive energy generation would proceed much more smoothly. With regard to the threat of embargoes, if the market were allowed to operate so that in event of an embargo prices would be free to adjust and clear the market, private speculation would start providing for storage and a futures market in oil would emerge.

Häfele

I think the dilemma is that the transition into nonresource constrained technologies requires thirty, forty, or fifty years, and that is beyond the play of the market forces.

Crow

I would like to address myself to that question. I think one of the aspects of the question you are raising is the fact that the capital resources needed to make this transition are going to be lumpy; that is, there will be very large aggregates and there is a question of whether the capital markets in the private sector of any country can handle this. Therefore, as a matter of public policy, it might be necessary to help develop

technologies such as fusion, the breeder reactor, and so forth. As a matter of fact, we see this in every country: the private sector is not willing to undertake the risks for developing these new technologies which are generally agreed to be highly desirable.

On conservation, the problem is quite different. Conservation is largely a microunit problem, an individual problem--the question of insulation, the question of waste-heat recycling in industrial processes, and so forth. Here it would seem to me that the market, such as Taylor has just described, should be adequate to provide the incentives for conservation. Perhaps it is not necessary to have an explicit intervention in conservation policy. Rather capital resources that can be mobilized by national governments should go to relaxing resource constraints.

Nordhaus

The question might be clearer if we put it into the language of planning. Look not at the price of oil or energy, but at the shadow price in terms of what its social or opportunity cost was in the last five years. The shadow price has gone up very sharply for Western countries. This means that we should now be willing to spend a lot more capital and labor to try to save a unit of this energy. Should we push harder into production or conservation? The answer is we should push both ways. We should push until the shadow return of investing in production is equal to the shadow return in conservation. Taylor's point was that a lot of that is done in a price system (whether market or socialist) because prices are used as signals for individual decisions. So to the extent that the price mechanism functions well, conservation would be performed by decentralized decisions.

The second question is then how well does the price mechanism function? The first point, demonstrated by Marchetti, is that it functions slowly. Crow adds, that with "lumpy" investments, the price mechanism may induce underinvestment. The most

important problem, however, may be what you guess about the time profile of the shadow price on energy looks like. Many people--such as Bouchet--feel that the shadow price of energy is going to come down. If this is so, then you should not invest heavily in those investment areas which have a long life, and that would mean in particular not to move into housing which has a lifetime of fifty years. Rather investment would concentrate on areas with rather shorter capital lifetimes.

Summary and Overview of the Workshop

William D. Nordhaus

We have heard a number of very fine papers and I cannot hope to give more than a superficial overview. I would first like to report on what are the substantial conclusions, then on what I perceive as unanswered or controversial questions.

The first question involves the problem of the responsiveness of energy consumption to price. My understanding is that virtually all reports provided evidence of substantial responsiveness of consumption to price changes, although the estimates vary widely, by a factor of about five. I take this to be the irreducible uncertainty at the current stage. In this regard, I should mention that in the contribution of the Soviet Union by Vigdorichik and Makarov they state that the correlation between industrial production and expenditure on energy is much stabler than between industrial production and consumption of energy in physical units. This implies a price elasticity of minus unity.

On a second and related point, there was some dissatisfaction with the time lag in most specifications. Especially in periods of rapid structural change, the econometric estimates of the lag of consumption behind price change appear to be quite uncertain. It is clear that either more observations must be found, or that theoretical, external considerations must be brought to bear to determine the lags.

The distinction between "free" and "captive" demand discussed by Khazzoom, relying upon the vintage capital goods theory, is a very useful approach in this regard. Marchetti's intervention on penetration curves, using purely behavioral principles, stresses the smooth and slow lags in changes in structure and in introduction of new processes. It is quite important to understand the mechanism behind these slowly moving

penetration curves. Are there any market or policy variables in these curves?

On the question of the relation of energy consumption to income, there was again general agreement that there is a strong relation between energy consumption and GNP, but the causal links and the exact elasticities varied widely between different studies.

On a methodological plane, four different contributions seemed particularly interesting. First, the development of models with variable input-output coefficients is of the greatest importance for medium term models. The early work of Jorgenson and his collaborators and the presentation by Waverman et al. at this Workshop seem to me to be fundamental methodological breakthroughs, avoiding the severe shortcomings of the usual input-output analysis with fixed coefficients. There are still some unresolved questions concerning the statistical properties of the estimates, so the practical usefulness of these is unproved.

Second, the model by Crow for analysis of the demand for new goods is a welcome break from the nonscientific guessing games that have often been played. The procedure should have very wide application outside of the energy area.

Third, the problem of nonlinear pricing in electricity, and the solution of Taylor, is an important advance for future empirical work. I should also reiterate Taylor's plea for empirical estimates of the possibility of changing the load curve.

Fourth, the use of subjective approaches, introduced by Leńcz, in the use of Delphi techniques should be looked at quite carefully. There is an important role for these techniques in capturing the effect of unmeasurable variables. The problem of designing subjective techniques and combining these with objective techniques is an unresolved problem.

In addition to these contributions, I think there are a number of problems which have been raised or unresolved: First, what is the appropriate mix of behavioral, statistical, and engineering programming? We have seen a complete spectrum of answers. On the one end, the approach of Jorgenson and Waverman et al. is to specify the complete system as a behavioral model. On the other end, we have the Grenoble group, and the Mäler group, and the Soviet approach which specifies norms (such as 20°C in a house) and uses optimization to specify the activities. Is there any preferred approach to this problem?

Second, there was considerable difference of opinion on the role of energy analysis, as presented by Slesser. Slesser's analysis stressed the energy content of goods as a critical variable in an economy, reflecting his concern that energy cannot be recycled and that thermodynamic potential is limited. Some participants argued that the analysis was unbalanced, and that constraints (capital, land, etc.) could also be important. There was no resolution of the debate.

I would suggest that there is a synthetic approach which can encompass both the energy analysts and the economists. This approach would use the principles of energy analysis (accounting for intersectoral flows in physical terms), but it would add two important features: First, the input-output system does not allow for alternative processes. It is crucial to have alternative input-output coefficients--as in the LP approach or the Jorgenson translog model. Second, the system must, in principle, include other sectors: steel, labor, land, etc. An augmented system would presumably satisfy both Slesser and his critics from a theoretical point of view. It would also allow a direct link between energy analysis and the theory of competitive or linear prices in an economy. It would allow direct tests of the feasibility problems.

One very clear area where energy analysis is very closely related to economic analysis is in the area of feasibility. Slesser noted that one must pay very close attention to the

"energy cost of energy," and this is also treated in the Charpentier paper. Stress is put on the fact that when the energy cost of a unit of energy is greater than one unit of energy, the system is no longer viable. Two points about this are important. First, if we consider the system as a simple input-output system, in physical terms, then there are well-known viability conditions known as the Hawkins-Simon conditions. These conditions are essentially the feasibility conditions that Slesser mentions, but are a bit more complicated in that they include indirect as well as direct effects. More interesting, perhaps, is that there is a "dual" relation to the Hawkins-Simon conditions in terms of prices. Consider a system in which prices are based on costs or competitive markets, with a linear-programming or input-output technology. Further consider what happens when the energy cost of energy gets closer and closer to unity. It is easily proven that the price of energy, relative to, say, labor, goes to infinity, and at the infeasibility point, energy cost equal to unity, the price is infinite. The point about this example is that there is a very close relation between the work that Slesser and energy analysts are doing and the earlier economic work on linear economic systems.

But the second point is that energy should not be lumped into one row or column of an input-output matrix as indeed it is not in any sensible empirical study. There are in fact different technological relations, or input-output or linear-programming coefficients, in different subsectors of the energy industry. To be rigorous, subsectors should be aggregated only when the rows or columns are linearly dependent. If they are not linearly dependent, then the prices will generally be different and it is incorrect to aggregate the subsectors no matter if the weights are BTU's, joules, thermodynamic potentials, or dollars. This is perhaps the other major objection to energy analysis: there are different forms of energy and a careful input-output study should separate out the forms of energy which have different coefficients. This

problem comes out most clearly in the discussion of electricity generation, since the energy cost is always greater than one, except for breeder reactors if one counts only fissile material as energy. The only way this paradox can be resolved is to realize that there is not a single energy constraint, but that there are many constraints: resources, capital, labor and so on.

My perception is that energy analysts and economists share a common point of view, and that if economists disaggregate-- and if energy analysis expands the number of sectors--they will meet and the substantive question can be resolved.

The third point is the problem of insertion of the energy sector in "global models." There was a general lack of attention to environmental variables. Unfortunately, energy tends to be a joint product with environmental degradation. It is a closely related problem then to estimate the demand for environmental quality. The problems here are extremely difficult from both a theoretical point of view and an empirical point of view. In the future, it would be nice to turn some of the immense talent working on demand for electricity loose on estimating the demand for environmental quality.

Finally, are there external limits which impose rigid or even elastic limits on energy consumption? For example, Ross argues that climatic effects on waste heat imply that energy consumption must be limited to the order of 1% of solar input. On the other hand, Marchetti argued that this upper limit can be changed by use of solar energy and by "global engineering" such as changes in albedo (whiteness) of the earth.

In addition, most economic studies do not find any saturation in energy demand at high levels of income. We thus have a serious dilemma: if both Ross and the economists are right, then at some time in the future the two will collide. What mechanisms exist to keep a nonsaturating demand for energy consistent with a negative climatic response? It would take an extreme act of faith to think that the demand will dovetail with the climatic needs.

